

**Z-SERIES
Z-SERIE
SERIES-Z**



Koken Z-series

Z series - Evolution of Automotive service Lineup



Z-series MOVIE

- CONCEPT -

Continued advancements in engine designs and structures are producing engines that are more complex and compact. Work environments are being transformed to cater towards increased demands on auto mechanics. We at Ko-ken TOOL CO., LTD., specialists in socket wrench manufacturing, have been committed to the development of automotive tools that are more suitable by pouring in our passion for perfecting hand tools and utilizing our experience obtained through over half a century of manufacturing to create the Z series. "Z" stands for "zeal". Through their unequalled performance, Z-Series tools are certain to become the mechanic's new standard for the next generation of automotive tools.

- Konzept -

Der ständige Fortschritt im Motorenbau führt zu immer komplexeren und kompakteren Motoren. Die Arbeitsmittel für den Automechaniker sollten auf diese neuen Anforderungen ausgerichtet sein. Wir, Ko-ken TOOL CO., LTD., als Spezialisten in der Herstellung von Steckschlüsseln, fühlen uns im besonderen Maße verpflichtet Werkzeuge zur Verfügung zu stellen, die diesen ständig veränderten Anforderungen gerecht werden. Unsere langjährige Erfahrung und unser absoluter Wille zur Perfektion halfen uns bei der Entwicklung der neuen Z-Serie. Das „Z“ steht hier für das englische Wort ZEAL (Begeisterung). Durch ihre beispiellose Leistung werden die Werkzeuge der Z-Serie zum neuen Standard der nächsten Generation von KFZ-Werkzeugen.

- Concept -

L'évolution continu des moteurs en matière de performance et design fait qu'ils deviennent de plus en plus complexes et compacts. De ce fait, l'environnement de travail du mécanicien doit être adapté. Chez Ko-ken TOOL CO., LTD., spécialiste dans la fabrication des clés à douilles, nous nous sommes dévoués à optimiser le travail du mécanicien en lui fournissant le parfait outil. C'est avec l'expérience d'un demi-siècle dans la production de l'adaptation à la demande du marché que nous avons réussi à développer la série „Z“. „Z“ vient du mot anglais „Zeal“, ce qui signifie enthousiasme. De manière inédite, les douilles de la série „Z“ deviendront le nouveau outil standard pour le mécanicien de demain.

- OVERALL - - Allgemein - - Généralités -



• Designed for best performance

The designs were thoroughly reviewed to produce the Z-series. All items in this series are now more compact. Foregoing standards, radical design concepts have been implemented in producing the Z series which enables maximum potential in all professional mechanics.

• Konzipiert für eine bessere Leistung

Das Design der Z-Serie wurde komplett überdacht. Alle Artikel dieser Serie sind im Allgemeinen kompakter als die herkömmlichen Steckschlüssel. Zukunftsweisende Standards und innovative Designkonzepte sorgen für ein optimiertes Anwendungspotenzial für den professionellen Mechaniker.

• Élaborée pour une meilleure performance

Un nouveau design a été spécialement conçu pour la série Z. Tous les articles sont plus compacts par rapport aux douilles normales. Un standard futuriste et une conception innovatrice garantissent un usage optimal au mécanicien professionnel.

• Tolerance – Square drive

Movement at the joint between a socket and a ratchet or other drive accessory has been accepted as unavoidable. To reduce this movement, we thoroughly reviewed dimensional accuracy of all the joint parts of Z-Series, and any movement in the rotating direction has now been minimized through production technologies.

• Toleranz Antriebsvierkante

Das Spiel an den Verbindungsstellen zwischen Steckschlüssel und Knarre oder zwischen anderen Betätigungselementen wurde bisher als unvermeidbar angesehen. Um dieses Spiel zu verringern wurden die Toleranzen aller möglichen Verbindungsstellen bei der Z-Serie verringert. Durch besondere Produktionstechniken wurde erreicht, dass es nun kaum noch Spiel in der Rotationsachse der Verbindungen mehr gibt.

• Tolérance – carré entraînant

Depuis toujours le jeu inévitable lors du raccord entre la douille et le cliquet, ou tout autre accessoire, a été déclaré comme inévitable. Pour réduire ce jeu, nous avons vérifié à fond l'exactitude des dimensions sur les raccords et grâce à notre technologie de production les rotations possibles ont pu être minimisées pour la série „Z“.

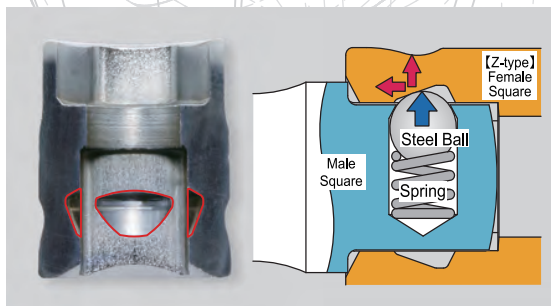
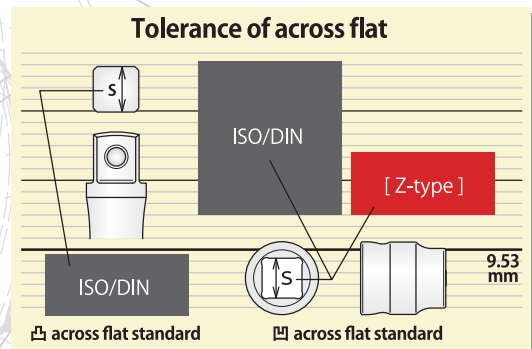

• Ball Holding Groove

The new Ball Holding system was installed. Any movement in the connecting direction has been reduced by a mechanism that pulls the parts together.

• Kugelfang

Die Werkzeuge der Z-Serie verfügen über spezielle Kugelfangrillen die eine noch sicherere Verbindung zwischen Betätigungswerkzeug und Steckschlüssel gewährleisten.

• Rainure pour bille

Un nouveau système de rainure pour bille a été installé. Tout mouvement dans le raccordement a été réduit par un mécanisme qui tire sur les parties raccordantes.

- REVERSIBLE RATCHET - - Knarre, verstellbar - - Cliquet, réversible -

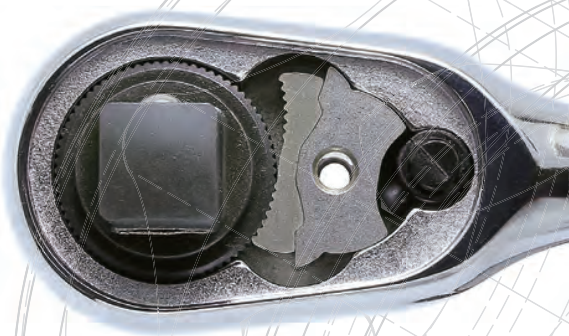

• 72 tooth gear Ratchet Handle - Light Ratchet Movement

This ratchet handle has a new mechanism for enhanced usability. This Ratchet has incredibly light turning torque that enables working on loosely tightened bolts. With the compact head and balanced design, the Z-Series ratchet has evolved into what can be called the "ideal ratchet handle".

• Leichtgängiger 72 Zahn Knarren Mechanismus

Diese Knarre verfügt über ein neues, sehr leichtgängige Getriebe mit 72 Zähnen. Nach dem Lösen der Schraube genügt meist deren Gewindereibung um den Mechanismus der Knarre auszulösen. Das ausgeglichene Design und der kompakte Knarrenkopf machen die Knarren der Z-Serie zur idealen Knarre.

• Cliquet à manche à 72 dents – cliquet à mouvement facile

Ce cliquet dispose d'un mécanisme à 72 dents permettant un usage élargi dû au mouvement facile du cliquet. Pour nous, les cliquets de la série „Z“ avec leurs têtes compactes et le design équilibré, sont les „cliquets à manche idéaux“.

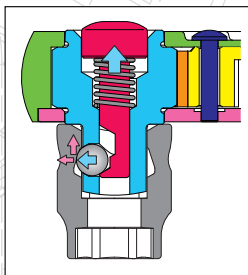
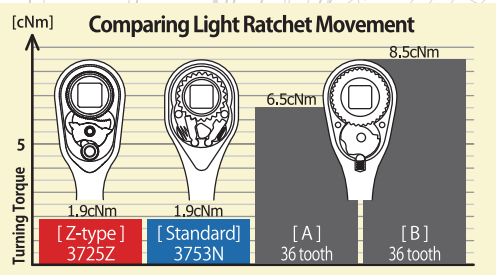

• Push release : Locking type

Innovative new locking mechanism is installed. This new mechanism achieved both of locking a socket and also unique feature of Z-series pulls parts together for tight connection.

• Knarre verstellbar mit Entriegelungsknopf

Der neue Mechanismus sorgt sowohl für einen sicheren Halt, als auch für einen fast spielfreien Sitz des Steckschlüssels auf dem Antriebsvierkant. Dies ist einzigartig bei der Z-Serie.

• Manche du cliquet

Le nouveau mécanisme assure un maintien sûr des douilles ainsi qu'un verrouillage presque sans jeu sur l'entraînement carré, une caractéristique unique de la série Z.

A, B : Other brand



- SOCKETS - - Steckschlüssel - - Douilles -

• Compact

The length and diameter of sockets have been significantly reduced. Ideal for working in confined and tight areas.

• Kompakt

Die Gesamtlänge und der Aussendurchmesser der Steckschlüssel wurden stark reduziert, dies erlaubt ein Arbeiten an schwer zugänglichen Stellen.

• Compact

La longueur intégrale et le diamètre des douilles sont remarquablement réduits, ce qui permet de travailler dans des endroits étroits ou difficilement accessibles.

• Tolerance -Hexagon Opening.

Foregoing the ISO and DIN standards, radical design concepts have been implemented in producing the Z series which enables maximum potential in all professional mechanics.

• Toleranzen der 6-kant Öffnungen

Bewährte Standards nach (DIN und ISO) einhaltend und innovative Design Konzepte sorgen für ein optimiertes Anwendungspotenzial für den professionellen Mechaniker.

• Tolérances des ouvertures hexagonales

Un standard préalable (ISO et DIN) et une conception innovante sont implantés dans la production des produits „Z“ pour en sortir un potentiel de travail maximal pour le mécanicien professionnel.

- Comparison of 10mm Sockets-

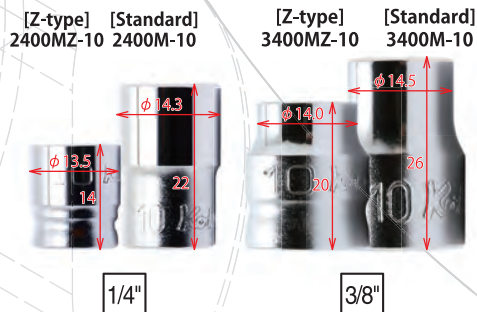

1/4"

3/8"

Tolerance - Across Flat

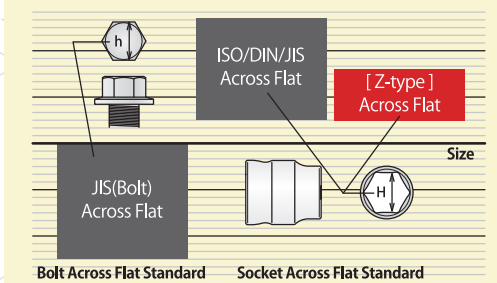

2400MZ

6-point Sockets
6-kant Steckschlüssel
Douilles 6-pans

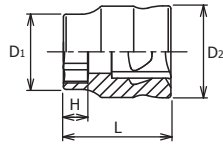

2400MZ (mm)	D ₁ (mm)	D ₂ (mm)	H (mm)	L (mm)	(g)	(pcs.)
4	6.4	11	3	14	6	10
4.5	7	11	3	14	6	10
5	7.6	11	3	14	6	10
5.5	8.2	11	3.5	14	6	10
6	8.8	11	3.5	14	6	10
7	9.9	11	3.5	14	6	10
8	11.1	11.7	4.5	15	7	10
10	13.5	12.5	7	15	8	10
11	14.7	13.2	7	15	9	10
12	15.9	14.4	7	15	11	10
13	17.1	15.6	7	15	14	10
14	18.3	16.8	7	15	16	10

RS2400MZ/12

Socket Set on magnetic Rail
Steckschlüsselsatz auf Magnetschiene
Jeu de douilles sur rail à aimant



RS2400MZ/12	12 Pieces Set/Rail 200mm	(g)
4, 4.5, 5, 5.5, 6, 7, 8, 10, 11, 12, 13, 14		228

2300XZ

6-point Sockets, Semi-Deep
6-kant Steckschlüssel, mittel-lang
Douilles, semi-profondes 6-pans

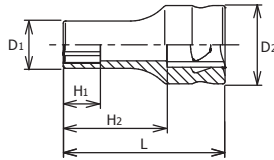

2300XZ (mm)	D ₁ (mm)	D ₂ (mm)	H ₁ (mm)	H ₂ (mm)	L (mm)	(g)	(pcs.)
5.5	8.2	11	6	20	30	10	10
6	8.8	11	7	20	30	10	10
7	9.9	11	8	20	30	11	10
8	11.1	11.7	9	20	30	13	10
10	13.5	12.5	11	20	30	16	10
11	14.7	13.2	12	20	30	19	10
12	15.9	14.4	13	20	30	22	10
13	17.1	15.6	14	20	30	26	10
14	18.3	16.8	14	20	30	30	10

RS2300XZ/9

Socket Set on magnetic Rail
Steckschlüsselsatz auf Magnetschiene
Jeu de douilles sur rail à aimant



RS2300XZ/9	9 Pieces Set/Rail 200mm	(g)
5.5, 6, 7, 8, 10, 11, 12, 13, 14		290

2300MZ

6-point Deep Sockets
6-kant-Steckschlüssel, lang
Douilles longues 6-pans

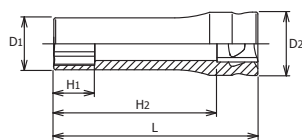

2300MZ (mm)	D ₁ (mm)	D ₂ (mm)	H ₁ (mm)	H ₂ (mm)	L (mm)	(g)	(pcs.)
4	6.4	11	5	41	50	14	10
4.5	7	11	5.5	41	50	16	10
5	7.6	11	6	41	50	16	10
5.5	8.2	11	6.5	41	50	16	10
6	8.8	11	7	41	50	17	10
7	9.9	11	8	41	50	20	10
8	11.1	11.7	9	41	50	22	10
10	13.5	12.5	11	41	50	29	10
11	14.7	13.2	12	41	50	33	10
12	15.9	14.4	13	41	50	40	10
13	17.1	15.6	14	41	50	45	10
14	18.3	16.8	16	41	50	51	10

RS2300MZ/12

Socket Set on magnetic Rail
Steckschlüsselsatz auf Magnetschiene
Jeu de douilles sur rail à aimant



RS2300MZ/12	12 Pieces Set/Rail 200mm	(g)
4, 4.5, 5, 5.5, 6, 7, 8, 10, 11, 12, 13, 14		445

1/4"

Z-series
Z-serie
Series-Z

Z-SERIES

HAND

TITANIUM

ACCESSORIES

SCREWDRIVERS

IMPACT

SLEEVE-DRIVE

PROTECTOR

INDUSTRIAL

AUTOMOTIVE

MOTORCYCLE

CONSTRUCTION

SPARE PART

	2441MZ (mm)	D ₁ (mm)	D ₂ (mm)	H (mm)	L (mm)	(g)	(pcs.)
New	8	12.3	11.7	4.5	30.5	18	10
New	10	14.3	11.7	4.5	30.5	20	10
New	12	16.8	11.7	5.5	31.5	25	10
New	13	18	11.7	5.5	31.5	27	10
New	14	20	11.7	7	33	31	10



2441MZ Nut Grip Universal Sockets **Nut Grip®**
Gelenk-Einsätze mit zweifacher Kugelhalterung
Douilles articulées à billes de retenue

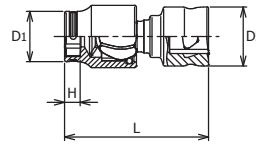

	2000Z-28 (PH)	D (mm)	H (mm)	L (mm)	(g)	(pcs.)
	1	11.2	12	28	9	10
	2	11.2	12	28	10	10
	3	11.2	12	28	10	10

	2000Z-50 (PH)	D (mm)	d (mm)	H (mm)	L (mm)	(g)	(pcs.)
	1	11.2	4	34	50	11	10
	2	11.2	5	34	50	13	10
	3	11.2	-	34	50	16	10

2000Z-28 / -50 PH Bit Sockets
Steckschlüssel für Kreuzschlitzschrauben, PH
Douilles tournevis pour vis à empreinte PH

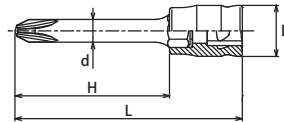

	2005Z-25	T x W (mm)	D (mm)	H (mm)	L (mm)	(g)	(pcs.)
	5	1.0 x 5.5	11.2	9	25	9	10
	6	1.2 x 6.5	11.2	9	25	10	10

2005Z-25 Bit Sockets for Slotted Head
Steckschlüssel für Schlitzschrauben
Douilles tournevis pour vis à fente

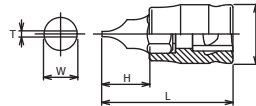

	2010MZ-25 (mm)	D (mm)	H (mm)	L (mm)	(g)	(pcs.)
	3	11.2	9	25	9	10
	4	11.2	9	25	9	10
	5	11.2	9	25	10	10
	6	11.2	9	25	10	10

2010MZ-25 / -50 Inhex Bit Sockets
Steckschlüssel für Innensechskant-Schrauben
Douilles tournevis pour vis 6-pans creux

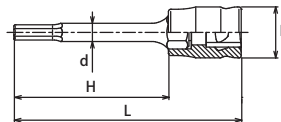

	2010MZ-50 (mm)	D (mm)	d (mm)	H (mm)	L (mm)	(g)	(pcs.)
	3	11.2	4	34	50	11	10
	4	11.2	5	34	50	13	10
	5	11.2	6	34	50	15	10
	6	11.2	-	34	50	17	10

RS20XXZ/9	9 Pieces Set/Rail 200mm	(g)
2000Z.28	1, 2, 3	213
2005Z.25	5, 6	
2010MZ.25	3, 4, 5, 6	

RS20XXZ/9 Socket Set on magnetic Rail



Steckschlüsselsatz auf Magnetschiene
Jeu de douilles sur rail à aimant



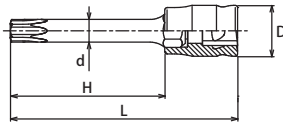

2025Z-28 / -50

 TORX® Bit Sockets
TORX® Bit-Steckschlüssel
Douilles tournevis, TORX®



2025Z-28 (T)	D (mm)	H (mm)	L (mm)	 (g)	 (pcs.)
T10	11.2	12	28	9	10
T15	11.2	12	28	9	10
T20	11.2	12	28	9	10
T25	11.2	12	28	10	10
T27	11.2	12	28	10	10
T30	11.2	12	28	10	10
T40	11.2	12	28	11	10

2025Z-50 (T)	D (mm)	d (mm)	H (mm)	L (mm)	 (g)	 (pcs.)
T10	11.2	4	34	50	11	10
T15	11.2	4	34	50	11	10
T20	11.2	4.5	34	50	12	10
T25	11.2	5	34	50	13	10
T27	11.2	5	34	50	13	10
T30	11.2	5.6	34	50	15	10
T40	11.2	-	34	50	17	10

RS2025Z/7-L28 RS2025Z/7-L50

 Socket Set on magnetic Rail
Steckschlüsselsatz auf Magnetschiene
Jeu de douilles sur rail à aimant







RS2025Z/7-L28	7 Pieces Set/Rail 200mm	 (g)
T10, T15, T20, T25, T27, T30, T40		195

RS2025Z/7-L50	7 Pieces Set/Rail 200mm	 (g)
T10, T15, T20, T25, T27, T30, T40		220

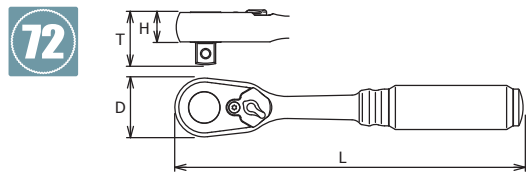
2725Z

Reversible Ratchet
Knarre, verstellbar
Cliquet, réversible







	D (mm)	T (mm)	H (mm)	L (mm)	 (g)	 (pcs.)
 2725Z	20.5	17.1	9.5	114	79	1

* Renewal Kits → 2725RK-2 → P320

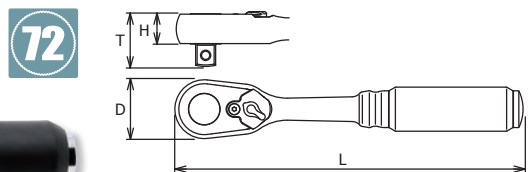
2725Z-160

Reversible Ratchet
Knarre, verstellbar
Cliquet, réversible 



	D (mm)	T (mm)	H (mm)	L (mm)	 (g)	 (pce.)
 2725Z-160	20.5	17.1	9.5	160	115	1

* Renewal Kits → 2725RK-2 → P320

 2725Z-160 have longer handle than standard, and can be loaded to excessive torque value. In the interest of your own safety always apply load evenly and progressively to avoid breakage and possible injury.

1/4"

Z-series
Z-serie
Series-Z

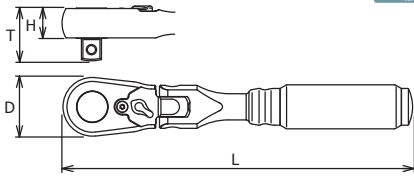

	D (mm)	T (mm)	H (mm)	L (mm)	(g)	(pce.)
2726Z	20.5	17.1	9.5	114	103	1

* Renewal Kits → 2725RK-2 → P320

2726Z Flexible Ratchet, Reversible (Short)
Gelenk-Knarre kurz, verstellbar
Cliquet articulé court, réversible

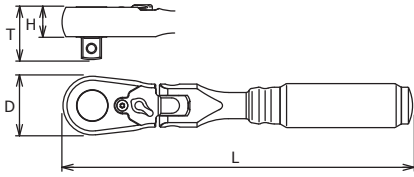

	D (mm)	T (mm)	H (mm)	L (mm)	(g)	(pce.)
2726Z-160	20.5	17.1	9.5	160	125	1

* Renewal Kits → 2725RK-2 → P320

2726Z-160 Flexible Ratchet, Reversible (long) ⚠
Gelenk-Knarre lang, verstellbar
Cliquet articulé long, réversible



⚠ 2726Z-160 have longer handle than standard, and can be loaded to excessive torque value. In the interest of your own safety always apply load evenly and progressively to avoid breakage and possible injury.



Z-SERIES
HAND
TITANIUM
ACCESSORIES
SCREWDRIVERS
IMPACT
SLEEVE-DRIVE
PROTECTOR
INDUSTRIAL
AUTOMOTIVE
MOTORCYCLE
CONSTRUCTION
SPARE PART

2760Z Extension Bars
Verlängerungen
Rallonges

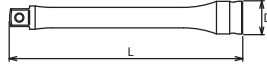

	D (mm)	L (mm)	(g)	(pcs.)
2760Z-50	11.5	50	21	10
2760Z-100	11.5	100	39	10
2760Z-150	11.5	150	58	10

2771Z Universal Joint
Gelenk-Einsatz
Joint articulé

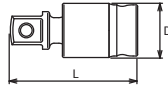

	D (mm)	L (mm)	(g)	(pcs.)
2771Z	11.7	29.9	15	10

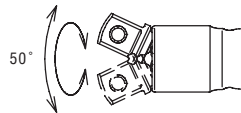

2772Z Universal Double Joint
Doppelgelenk-Einsatz
Joint articulé double

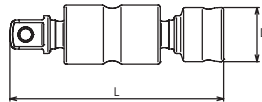

	D (mm)	L (mm)	(g)	(pcs.)
2772Z	11.7	46	26	10

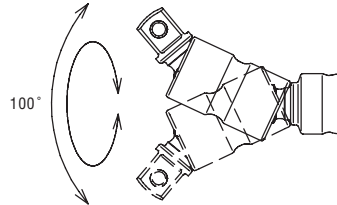

2756Z Quick Spinner
Rändel-Drehscheibe
Lanceur



	D (mm)	L (mm)	(g)	(pcs.)
2756Z	20.3	18	15	10

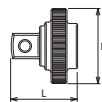

2756Z-3/8 Quick Spinner, Adaptor
Rändel-Drehscheibe als Adaptor
Lanceur, adaptateur

2756Z-1/2



2756Z-3/8







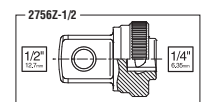
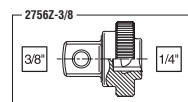
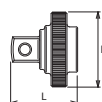



2756Z-1/2

	D (mm)	L (mm)	(g)	(pcs.)
2756Z-3/8	20.3	21.5	24	10
2756Z-1/2	20.3	26	35	10







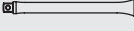

1/4"

Z-series
Z-serie
Series-Z

P2285Z		26 Pieces Set/△=660g	
PLASTIC CASE:W245xH120xT45			
Sockets	Accessories		
 2400MZ 6-pt. Sockets 4, 4.5, 5, 5.5, 6, 7, 8, 10, 11, 12, 13, 14		2725Z	
 2000Z.28 1, 2, 3		2756Z	
 2005Z.25 5, 6		2771Z	
 2010MZ.25 3, 4, 5, 6		2760Z-50	
		2760Z-150	



P2285Z Set in PE-foam tray
Steckschlüsselsatz in Weichschaumeinlage
Set disposé dans boîte de rangement en mousse souple



2286Z		17 Pieces Set/△=780g	
BLACK METAL CASE:W240xH100xT32mm			
Sockets	Accessories		
 2400MZ 6-pt. Sockets 4, 5, 5.5, 6, 7, 8, 10, 11, 12, 13, 14		2725Z	
		2756Z	
		2771Z	
		2760Z-50	
		2760Z-100	
		2760Z-150	

2286Z Set in PE-foam tray
Steckschlüsselsatz in Weichschaumeinlage
Set disposé dans boîte de rangement en mousse souple



2285ZE		10 Pieces Set/△=300g	
Rail 200mm/PLASTIC BAG			
Sockets	Accessories		
 2400MZ 6-pt. Sockets 5.5, 6, 7, 8, 10, 12, 13, 14		2725Z	
		2756Z	

2285ZE Socket Sets
Steckschlüssel Sätze
Jeu de clés à douilles



Z-SERIES
HAND
TITANIUM
ACCESSORIES
SCREWDRIVERS
IMPACT
SLEEVE-DRIVE
PROTECTOR
INDUSTRIAL
AUTOMOTIVE
MOTORCYCLE
CONSTRUCTION
SPARE PART

3400MZ

6-point Sockets
6-kant Steckschlüssel
Douilles 6-pans

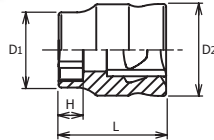

3400MZ (mm)	D ₁ (mm)	D ₂ (mm)	H (mm)	L (mm)	(g)	(pcs.)
5.5	8.5	17	3.5	19	16	10
6	9.1	17	3.5	19	17	10
7	10.3	17	3.5	19	17	10
8	11.5	17	4.5	20	17	10
10	14	17	4.5	20	18	10
11	15.3	17	5.5	21	18	10
12	16.5	17	5.5	21	19	10
13	17.8	17	8.5	21	19	10
14	19	17	8.5	21	20	10
15	20.2	18.2	8.5	21	24	10
16	21.3	19.3	8.5	21	28	10
17	22.5	20.5	8.5	21	32	10
18	23.6	21.6	9.5	22	38	10
19	24.8	22.8	9.5	22	41	10
21	27	25	10.5	23	51	10
22	28.3	26.3	10.5	23	58	10

3400MZ is designed 5-9mm shorter than standard 3400M.
Ideal for working in confined and tight areas.

RS3400MZ/8 RS3400MZ/12

Socket Set on magnetic Rail
Steckschlüsselsatz auf Magnetschiene
Jeu de douilles sur rail à aimant



RS3400MZ/8	8 Pieces Set/Rail 200mm	(g)
8, 10, 11, 12, 13, 14, 17, 19		320

RS3400MZ/12	12 Pieces Set/Rail 300mm	(g)
7, 8, 10, 11, 12, 13, 14, 15, 16, 17, 18, 19		490

3300XZ

6-point Sockets, Semi-Deep
6-kant Steckschlüssel, mittel-lang
Douilles, semi-profondes 6-pans

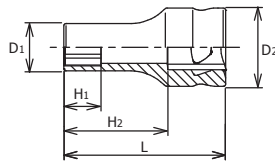

3300XZ (mm)	D ₁ (mm)	D ₂ (mm)	H ₁ (mm)	H ₂ (mm)	L (mm)	(g)	(pcs.)
7	10.3	17	8	23	35	23	10
8	11.5	17	9	23	35	24	10
10	14	17	11	23	35	26	10
11	15.3	17	12	23	35	28	10
12	16.5	17	13	23	35	29	10
13	17.8	17	14	23	35	32	10
14	19	17	16	23	35	34	10
15	20.2	18.2	16	23	35	40	10
16	21.3	19.3	16.5	23	35	45	10
17	22.5	20.5	16.5	23	35	50	10
18	23.6	21.6	16.5	23	35	56	10
19	24.8	22.8	18	23	35	60	10

RS3300XZ/8 RS3300XZ/12

Socket Set on magnetic Rail
Steckschlüsselsatz auf Magnetschiene
Jeu de douilles sur rail à aimant

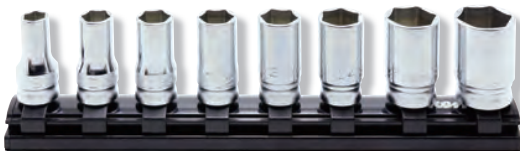

RS3300XZ/8	8 Pieces Set/Rail 200mm	(g)
8, 10, 11, 12, 13, 14, 17, 19		420

RS3300XZ/12	12 Pieces Set/Rail 300mm	(g)
7, 8, 10, 11, 12, 13, 14, 15, 16, 17, 18, 19		630

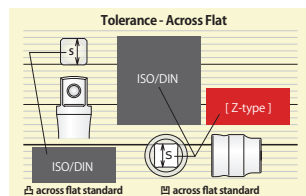
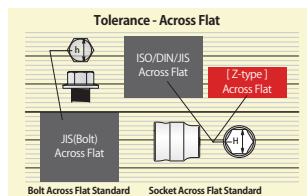

Manufacturing tolerance is precisely controlled to achieve a secure fitting.

BALL HOLDING GROOVE

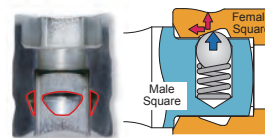

The inventive Ball Holding system of the Z-series allows a secure connection between Socket and Handle.

Die Werkzeuge der Z-Serie verfügen über spezielle Kugelfangrillen, die eine noch sicherere Verbindung zwischen Betätigungswerkzeug und Steckschlüssel gewährleisten.

La série Z dispose d'une rainure de fixation pour bille spéciale, qui améliore nettement la fixation entre douille et cliquet.

3/8"

Z-series
Z-serie
Series-Z

3300MZ (mm)	D ₁ (mm)	D ₂ (mm)	H ₁ (mm)	H ₂ (mm)	L (mm)	(g)	(pcs.)
7	10.3	17	8	41.5	55	29	10
8	11.5	17	9	41.5	55	34	10
10	14	17	11	41.5	55	43	10
11	15.3	17	12	41.5	55	45	10
12	16.5	17	13	41.5	55	49	10
13	17.8	17	14	41.5	55	52	10
14	19	17	16	41.5	55	55	10
15	20.2	18.2	16	40.5	55	65	10
16	21.3	19.3	17	40.5	55	74	10
17	22.5	20.5	18	40.5	55	83	10
18	23.6	21.6	19	39.5	55	90	10
19	24.8	22.8	20	39.5	55	95	10



3300MZ ○ 6-point Deep Sockets
6-kant-Steckschlüssel, lang
Douilles longues 6-pans

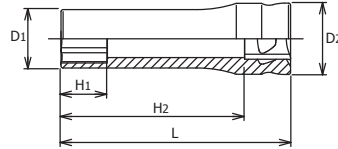

RS3300MZ/8	8 Pieces Set/Rail 200mm	(g)
8, 10, 11, 12, 13, 14, 17, 19		600

RS3300MZ/12	12 Pieces Set/Rail 300mm	(g)
7, 8, 10, 11, 12, 13, 14, 15, 16, 17, 18, 19		900

RS3300MZ/8 ○ Socket Set on magnetic Rail
Steckschlüsselsatz auf Magnetschiene
RS3300MZ/12 Jeu de douilles sur rail à aimant



RS3X00MZ/12	12 Pieces Set/Rail 300mm	(g)
3400MZ	8, 10, 11, 12, 13, 14, 17, 19	550
3300MZ	8, 10, 12, 14	

RS3X00MZ/12 ○ Socket Set on magnetic Rail
Steckschlüsselsatz auf Magnetschiene
Jeu de douilles sur rail à aimant



3300CZ (mm)	D (mm)	H ₁ (mm)	H ₂ (mm)	L (mm)	(g)	(pcs.)
14	18.4	11	17	70	67	10
16	20.5	13	17	70	71	10
18	22.9	12	17	70	75	10
20.8	26.3	13.5	17	70	105	10

Slim & light weight body with smaller outside diameter for work in tight spaces.

Spring clip type spark plug sockets caused deforming the clip if it would be used with shallow engagement.



3300CZ ○ Spark Plug Sockets with Spring Clips
Zündkerzen-Schlüssel mit Haltefeder
Douilles avec ressorts de retenues pour bougies

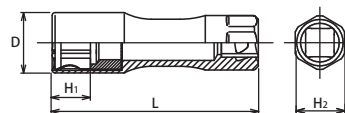

3305PZ (mm)	D (mm)	H ₁ (mm)	H ₂ (mm)	L (mm)	(g)	(pcs.)
14	17.9	8	17	70	56	10
16	20	8	17	70	55	10

Spark Plug Socket with Magnet, 12-pt. opening: size 14mm



The magnet could be broken with any impacts. Please handle with care.

3305PZ Spark Plug Socket with Magnet, 12-pt. opening
Zündkerzensteckschlüssel mit Magnet, 12-kant
Douille pour bougies, avec aimant, 12-pans

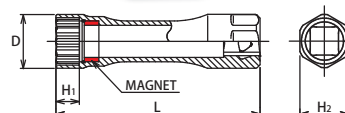

Z-SERIES
HAND
TITANIUM
ACCESSORIES
SCREWDRIVERS
IMPACT
SLEEVE-DRIVE
PROTECTOR
INDUSTRIAL
AUTOMOTIVE
MOTORCYCLE
CONSTRUCTION
SPARE PART

3441MZ

 Nut Grip Universal Sockets **Nut Grip®**
Gelenk-Einsätze mit zweifacher Kugelhalterung
Douilles articulées à billes de retenue

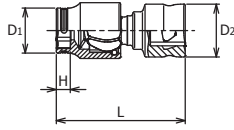

3441MZ (mm)	D ₁ (mm)	D ₂ (mm)	H (mm)	L (mm)	(g)	(pcs.)
New 8	12	17	4.5	41.5	45	10
New 10	14.5	17	4.5	41.5	47	10
New 12	16.8	17	5.5	42.5	50	10
New 13	17.8	17	5.5	42.5	53	10
New 14	19.5	17	7	44	55	10
New 17	23.4	17	8.5	45.5	66	10

3010MZ-50 / -75

 Inhex Bit Sockets
Steckschlüssel für Innensechskant-Schrauben
Douilles tournevis pour vis 6-pans creux

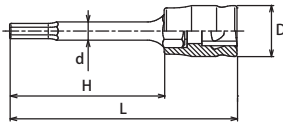

3010MZ-50 (mm)	D (mm)	d (mm)	H (mm)	L (mm)	(g)	(pcs.)
3	17	4	23.5	50	28	10
4	17	5	23.5	50	29	10
5	17	6	23.5	50	30	10
6	17	7	23.5	50	35	10
7	17	-	23.5	50	38	10
8	17	-	23.5	50	40	10
10	17	-	23.5	50	50	10
12	19	-	23.5	50	70	10

3010MZ-75 (mm)	D (mm)	d (mm)	H (mm)	L (mm)	(g)	(pcs.)
3	17	6	48.5	75	33	10
4	17	6	48.5	75	35	10
5	17	6	48.5	75	36	10
6	17	7	48.5	75	41	10
7	17	7.9	48.5	75	45	10
8	17	-	48.5	75	48	10
10	17	-	48.5	75	65	10
12	19	-	48.5	75	90	10

RS3010MZ/8-L50 RS3010MZ/8-L75

 Socket Set on magnetic Rail
Steckschlüsselsatz auf Magnetschiene
Jeu de douilles sur rail à aimant



RS3010MZ/8-L50	8 Pieces Set/Rail 200mm	(g)
3, 4, 5, 6, 7, 8, 10, 12		460

RS3010MZ/8-L75	8 Pieces Set/Rail 200mm	(g)
3, 4, 5, 6, 7, 8, 10, 12		530

3025Z-50 / -75

 TORX® Bit Sockets
TORX® Bit-Steckschlüssel
Douilles tournevis, TORX®

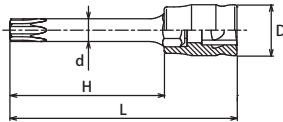

3025Z-50 (T)	D (mm)	d (mm)	H (mm)	L (mm)	(g)	(pcs.)
T10	17	3	23.5	50	27	10
T15	17	3.5	23.5	50	28	10
T20	17	3.9	23.5	50	28	10
T25	17	4.5	23.5	50	29	10
T27	17	5	23.5	50	30	10
T30	17	5.6	23.5	50	31	10
T40	17	6.7	23.5	50	35	10
T45	17	7.83	23.5	50	38	10
T50	17	8.90	23.5	50	48	10
T55	19	11.3	23.5	50	70	10

3025Z-75 (T)	D (mm)	d (mm)	H (mm)	L (mm)	(g)	(pcs.)
T20	17	4.5	48.5	75	32	10
T25	17	5	48.5	75	33	10
T27	17	5	48.5	75	33	10
T30	17	5.6	48.5	75	35	10
T40	17	6.7	48.5	75	41	10
T45	17	7.9	48.5	75	45	10
T50	17	8.9	48.5	75	55	10
T55	19	11.3	48.5	75	80	10

RS3025Z/8-L50 RS3025Z/8-L75

 Socket Set on magnetic Rail
Steckschlüsselsatz auf Magnetschiene
Jeu de douilles sur rail à aimant



RS3025Z/8-L50	8 Pieces Set/Rail 200mm	(g)
T20, T25, T27, T30, T40, T45, T50, T55		450

RS3025Z/8-L75	8 Pieces Set/Rail 200mm	(g)
T20, T25, T27, T30, T40, T45, T50, T55		480

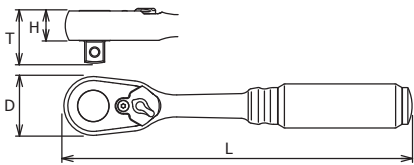

72

2725Z-3/8

Reversible Ratchet Short
Knarre kurz, verstellbar
Cliquet court, réversible



	D (mm)	T (mm)	H (mm)	L (mm)	(g)	(pce.)
2725Z-3/8	20.5	20.5	9.5	114	83	1

* Renewal Kits → 2725RK-2(3/8) → P320

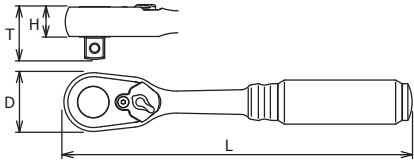

72

2725Z-3/8 (L160)

Reversible Ratchet (long)
Knarre lang, verstellbar ⚠
Cliquet long, réversible



	D (mm)	T (mm)	H (mm)	L (mm)	(g)	(pce.)
2725Z-3/8 (L160)	20.5	20.5	9.5	160	120	1

* Renewal Kits → 2725RK-2(3/8) → P320

⚠ 2725Z-3/8 (L160) have longer handle than standard, and can be loaded to excessive torque value. In the interest of your own safety always apply load evenly and progressively to avoid breakage and possible injury.

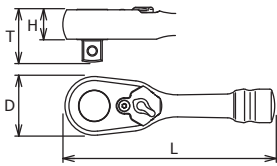

72

3725ZS

Reversible Ratchet Short
Knarre kurz, verstellbar
Cliquet court, réversible



	D (mm)	T (mm)	H (mm)	L (mm)	(g)	(pce.)
3725ZS	28	24.5	13.7	100	157	1

* Renewal Kits → 3725RK-2 → P320

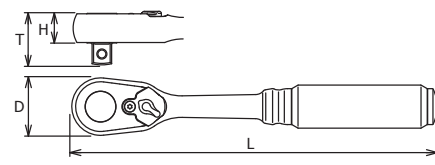

72

3725Z

Reversible Ratchet
Knarre, verstellbar
Cliquet, réversible



	D (mm)	T (mm)	H (mm)	L (mm)	(g)	(pce.)
3725Z	28	24.5	13.7	178	236	1

* Renewal Kits → 3725RK-2 → P320

72

3725Z-280

Reversible Ratchet (long)
Knarre lang, verstellbar ⚠
Cliquet long, réversible



	D (mm)	T (mm)	H (mm)	L (mm)	(g)	(pce.)
3725Z-280	28	24.5	13.7	280	360	1

* Renewal Kits → 3725RK-2 → P320

⚠ 3725Z-280 have longer handle than standard, and can be loaded to excessive torque value. In the interest of your own safety always apply load evenly and progressively to avoid breakage and possible injury.

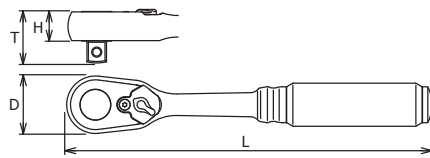

Z-series
Z-serie
Series-Z **3/8"**

2725ZB-3/8

Reversible Ratchet with Quick Release Button
Knarre, verstellbar mit Entriegelungsknopf
Cliquet, réversible avec bouton de débrayage



	D (mm)	T (mm)	H (mm)	L (mm)	(g)	(pce.)
New 2725ZB-3/8	20.5	20.5	9.5	114	83	1

* Renewal Kits → 2725BRK-1(3/8) → P320

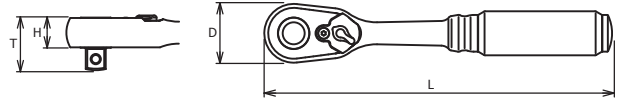

2725ZB-3/8 (L160)

Reversible Ratchet Long with Quick Release Button
Knarre lang, verstellbar mit Entriegelungsknopf
Cliquet long, réversible, avec bouton de déverrouillage



	D (mm)	T (mm)	H (mm)	L (mm)	(g)	(pce.)
New 2725ZB-3/8 (L160)	20.5	20.5	9.5	160	120	1

* Renewal Kits → 2725BRK-1(3/8) → P320

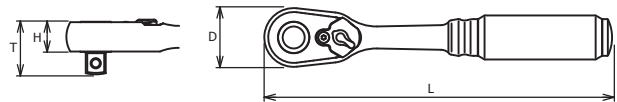

! 2725ZB-3/8(L160) have longer handle than standard, and can be loaded to excessive torque value. In the interest of your own safety always apply load evenly and progressively to avoid breakage and possible injury.

3725ZSB

Reversible Ratchet Short with Quick Release Button
Knarre, verstellbar mit Entriegelungsknopf
Cliquet, réversible avec bouton de débrayage



	D (mm)	T (mm)	H (mm)	L (mm)	(g)	(pce.)
New 3725ZSB	28	24.5	13.7	100	157	1

* Renewal Kits → 3725BRK-1 → P320

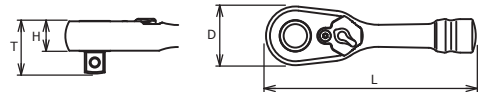

3725ZB

Reversible Ratchet with Quick Release Button
Knarre, verstellbar mit Entriegelungsknopf
Cliquet, réversible avec bouton de débrayage

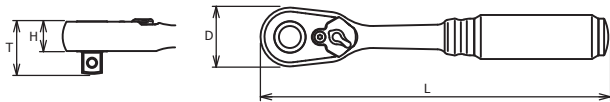

	D (mm)	T (mm)	H (mm)	L (mm)	(g)	(pce.)
New 3725ZB	28	24.5	13.7	178	236	1

* Renewal Kits → 3725BRK-1 → P320

3725ZB-280

Reversible Ratchet Long with Quick Release Button
Knarre lang, verstellbar mit Entriegelungsknopf
Cliquet long, réversible, avec bouton de déverrouillage

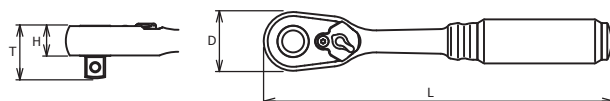

	D (mm)	T (mm)	H (mm)	L (mm)	(g)	(pce.)
New 3725ZB-280	28	24.5	13.7	280	360	1

* Renewal Kits → 3725BRK-1 → P320

! 3725ZB-280 have longer handle than standard, and can be loaded to excessive torque value. In the interest of your own safety always apply load evenly and progressively to avoid breakage and possible injury.

3/8"

Z-series
Z-serie
Series-Z

Z-SERIES
HAND
TITANIUM
ACCESSORIES
SCREWDRIVERS
IMPACT
SLEEVE-DRIVE
PROTECTOR
INDUSTRIAL
AUTOMOTIVE
MOTORCYCLE
CONSTRUCTION
SPARE PART

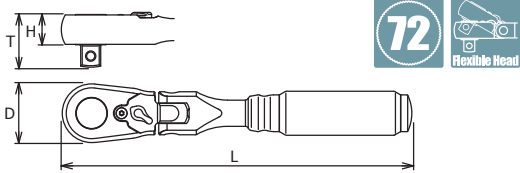

	D (mm)	T (mm)	H (mm)	L (mm)	(g)	(pce.)
2726Z-3/8	20.5	20.5	9.5	114	107	1

* Renewal Kits → 2725RK-2(3/8) → P320

2726Z-3/8 Flexible Ratchet, Reversible (Short)
Gelenk-Knarre kurz, verstellbar
Cliquet articulé court, réversible

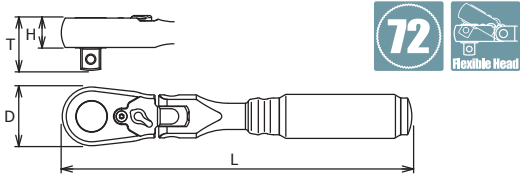

	D (mm)	T (mm)	H (mm)	L (mm)	(g)	(pce.)
2726Z-3/8 (L160)	20.5	20.5	9.5	160	130	1

* Renewal Kits → 2725RK-2(3/8) → P320

2726Z-3/8 (L160) Flexible Ratchet long, Reversible
Gelenk-Knarre lang, verstellbar
Cliquet articulé long, réversible



⚠ 2726Z-3/8 (L160) have longer handle than standard, and can be loaded to excessive torque value. In the interest of your own safety always apply load evenly and progressively to avoid breakage and possible injury.

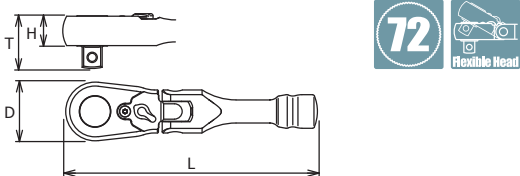

	D (mm)	T (mm)	H (mm)	L (mm)	(g)	(pce.)
3726ZS	28	24.5	13.7	120	196	1

* Renewal Kits → 3725RK-2 → P320

3726ZS Flexible Ratchet, Reversible (Short)
Gelenk-Knarre kurz, verstellbar
Cliquet articulé court, réversible

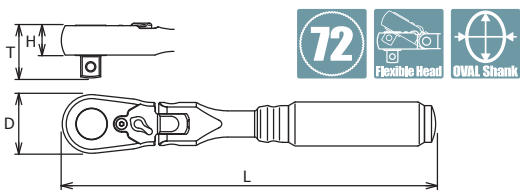

	D (mm)	T (mm)	H (mm)	L (mm)	(g)	(pce.)
3726Z	28	24.5	13.7	178	317	1

* Renewal Kits → 3725RK-2 → P320

3726Z Flexible Ratchet, Reversible
Gelenk-Knarre, verstellbar
Cliquet articulé, réversible



	D (mm)	T (mm)	H (mm)	L (mm)	(g)	(pce.)
3726Z-280	28	24.5	13.7	280	420	1

* Renewal Kits → 3725RK-2 → P320

⚠ 3726Z-280 have longer handle than standard, and can be loaded to excessive torque value. In the interest of your own safety always apply load evenly and progressively to avoid breakage and possible injury.

3726Z-280 Flexible Ratchet long, Reversible
Gelenk-Knarre lang, verstellbar
Cliquet articulé long, réversible

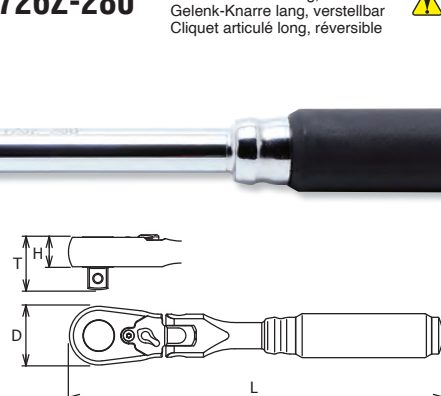

Z-series
Z-serie
Series-Z **3/8"**

2726ZB-3/8

Flexible Ratchet, Reversible with Quick Release Button
Gelenk-Knarre, verstellbar mit Entriegelungsknopf
Cliquet, articulée, réversible avec bouton de débrayage

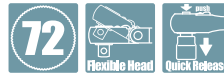

	D (mm)	T (mm)	H (mm)	L (mm)	(g)	(pce.)
New 2726ZB-3/8	20.5	20.5	9.5	114	107	1

* Renewal Kits → 2725BRK-1(3/8) → P320

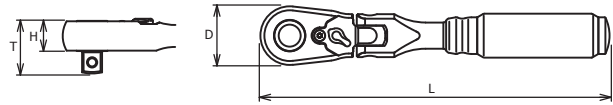

2726ZB-3/8 (L160)

Flexible Ratchet long, Reversible with Quick Release Button
Gelenk-Knarre lang, verstellbar mit Entriegelungsknopf
Cliquet long articulée, réversible avec bouton de débrayage

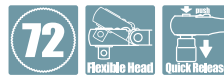

	D (mm)	T (mm)	H (mm)	L (mm)	(g)	(pce.)
New 2726ZB-3/8 (L160)	20.5	20.5	9.5	160	130	1

* Renewal Kits → 2725BRK-1(3/8) → P320

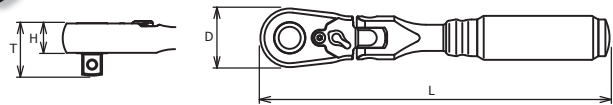

! 2726ZB-3/8(L160) have longer handle than standard, and can be loaded to excessive torque value. In the interest of your own safety always apply load evenly and progressively to avoid breakage and possible injury.

3726ZSB

Flexible Ratchet, Reversible with Quick Release Button
Gelenk-Knarre, verstellbar mit Entriegelungsknopf
Cliquet, articulée, réversible avec bouton de débrayage

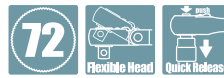

	D (mm)	T (mm)	H (mm)	L (mm)	(g)	(pce.)
New 3726ZSB	28	24.5	13.7	120	196	1

* Renewal Kits → 3725BRK-1 → P320

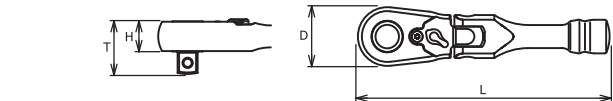

3726ZB

Flexible Ratchet, Reversible with Quick Release Button
Gelenk-Knarre, verstellbar mit Entriegelungsknopf
Cliquet, articulée, réversible avec bouton de débrayage



OVAL SHAPE SHANK

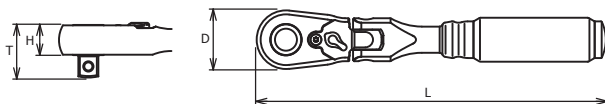

	D (mm)	T (mm)	H (mm)	L (mm)	(g)	(pce.)
New 3726ZB	28	24.5	13.7	178	317	1

* Renewal Kits → 3725BRK-1 → P320

3726ZB-280

Flexible Ratchet long, Reversible with Quick Release Button
Gelenk-Knarre lang, verstellbar mit Entriegelungsknopf
Cliquet long articulée, réversible avec bouton de débrayage

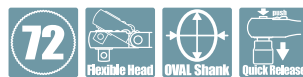

OVAL SHAPE SHANK

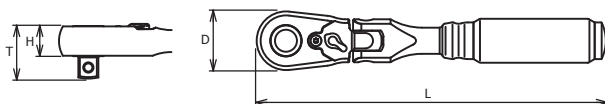

	D (mm)	T (mm)	H (mm)	L (mm)	(g)	(pce.)
New 3726ZB-280	28	24.5	13.7	280	420	1

* Renewal Kits → 3725BRK-1 → P320

! 3726ZB-280 have longer handle than standard, and can be loaded to excessive torque value. In the interest of your own safety always apply load evenly and progressively to avoid breakage and possible injury.

3/8"

Z-series
Z-serie
Series-Z



3768Z-250
3768Z-400 ⚠️

Hinge Handle
Gelenkgriff
Poignée articulée



	D (mm)	L (mm)	(g)	(pcs.)
3768Z-250	20.5	250	309	5
3768Z-400	20.5	400	500	2

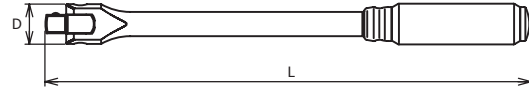

* Renewal Kits → **3768ZRK** → **P321**

⚠️ 3768Z-400 have longer handle than standard, and can be loaded to excessive torque value. In the interest of your own safety always apply load evenly and progressively to avoid breakage and possible injury.

3760Z Extension Bars
Verlängerungen
Rallonges



	D (mm)	L (mm)	(g)	(pcs.)
3760Z-75	17.5	75	66	10
3760Z-125	17.5	125	103	10
3760Z-250	17.5	250	195	5

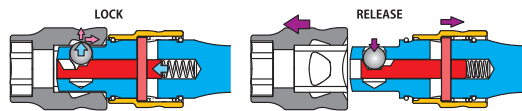
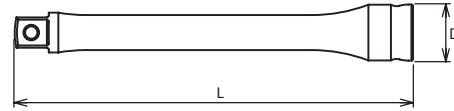

3760LZ Locking Extension Bars
Verriegelbare Verlängerungen
Barres d'extension verrouillables ⚠️



	D ₁ (mm)	D ₂ (mm)	L (mm)	(g)	(pcs.)
New 3760LZ-75	17.5	16.5	75	75	10
New 3760LZ-125	17.5	16.5	125	105	10
New 3760LZ-250	17.5	16.5	250	185	5

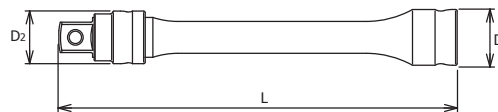

⚠️ You may not hold the sliding part while moving to avoid heating up by friction and reduction by wear.

Bitte das gleitende Teil während der Bewegung nicht festhalten, um eine Erhitzung durch Reibung und durch Verschleiß zu vermeiden.

Veuillez ne pas tenir la pièce coulissante pendant le mouvement, afin d'éviter un échauffement dû à la friction et à l'usure.

	D (mm)	L (mm)	(g)	(pcs.)
3771Z	18	42.5	44	10



3771Z Universal Joint
Gelenk-Einsatz
Joint articulé

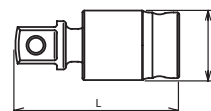
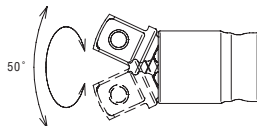

	D (mm)	L (mm)	(g)	(pcs.)
3772Z	17	65	76	10

3772Z Universal Double Joint
Doppelgelenk-Einsatz
Joint articulé double

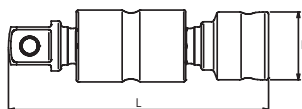
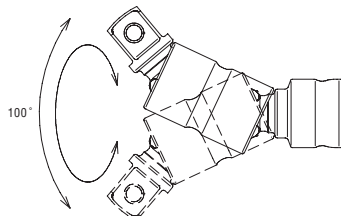

Z-SERIES
HAND
TITANIUM
ACCESSORIES
SCREWDRIVERS
IMPACT
SLEEVE-DRIVE
PROTECTOR
INDUSTRIAL
AUTOMOTIVE
MOTORCYCLE
CONSTRUCTION
SPARE PART

Z-series
Z-serie
Series-Z **3/8"**

3756Z Quick Spinner
Rändel-Drehscheibe
Lanceur



	D (mm)	L (mm)	(g)	(pcs.)
3756Z	28	25	40	10

Outside diameter is smaller compared to standard 3756.
Ideal for working in combination with 3725Z



3756ZS Quick Spinner
Rändel-Drehscheibe
Lanceur



	D (mm)	L (mm)	(g)	(pcs.)
3756ZS	20.3	25	26	10

Ideal for working in combination with 2725Z-3/8 and 2726Z-3/8.

3756Z-1/2 Quick Spinner, Adaptor
Rändel-Drehscheibe als Adaptor
Lanceur, adapteur



	D (mm)	L (mm)	(g)	(pcs.)
3756Z-1/2	28	29	52	10

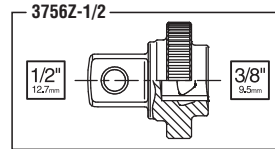

3322AZ-75 Extension Adaptor
Verlängerungsadapter
Reduction adapteur-rallonge



	D (mm)	L (mm)	(g)	(pcs.)
3322AZ-75	17.5	75	42	10

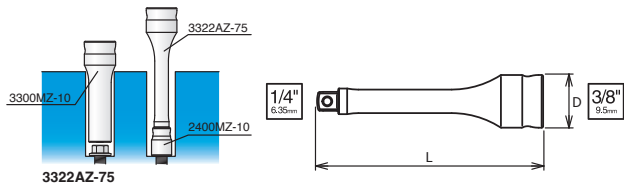

Z-SERIES

HAND

TITANIUM

SCREWDRIVERS ACCESSORIES

IMPACT

SLEEVE-DRIVE

PROTECTOR









INDUSTRIAL

AUTOMOTIVE

CONSTRUCTION MOTORCYCLE



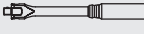

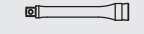
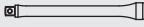
SPARE PART



3285Z		26 Pieces Set/△△=2,100g	
PLASTIC TRAY:W390xT180xH25			
Sockets	Accessories		
 3400MZ 6-pt. Sockets 5.5, 6, 7, 8, 10, 12, 13, 14, 17, 19, 21, 22	 3725Z		
	 3756Z		
 3300MZ 6-pt. Deep Sockets 8, 10, 12, 14	 3771Z		
 3300CZ Spark Plug Sockets 14, 16, 20.8	 3768Z-250		
	 3760Z-75		
	 3760Z-125		
	 3760Z-250		









3285Z Set in PE-foam tray
Steckschlüsselsatz in Weichschaumeinlage
Set disposé dans boîte de rangement en mousse souple



3285ZA		15 Pieces Set/△△=750g	
PLASTIC TRAY:W300xT90xH25			
Sockets	Accessories		
 3400MZ 6-pt. Sockets 5.5, 6, 7, 8, 10, 12, 13, 14, 17, 19, 21, 22	 3725Z		
	 3756Z		
	 3771Z		

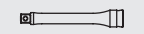

3285ZA Set in PE-foam tray
Steckschlüsselsatz in Weichschaumeinlage
Set disposé dans boîte de rangement en mousse souple



3286Z		21 Pieces Set/△△=2,600g	
BLACK METAL CASE:W415xH120xT50mm			
Sockets	Accessories		
 3400MZ 6-pt. Sockets 7, 8, 10, 11, 12, 13, 14, 15, 16, 17, 18, 19, 21, 22	 3725Z		
	 3756Z		
	 3771Z		
	 3768Z-250		
	 3760Z-75		
	 3760Z-125		
	 3760Z-250		

3286Z Set in PE-foam tray
Steckschlüsselsatz in Weichschaumeinlage
Set disposé dans boîte de rangement en mousse souple



3285ZE		9 Pieces Set/△△=600g	
Rail 200mm/PLASTIC BAG			
Sockets	Accessories		
 3400MZ 6-pt. Sockets 8, 10, 12, 13, 14, 17, 19	 3725Z		
	 3756Z		

3285ZE Socket Sets
Steckschlüssel Sätze
Jeu de clés à douilles



Z-series
Z-serie
Series-Z

1/2"

4400MZ

6-point Sockets
6-kant Steckschlüssel
Douilles 6-pans

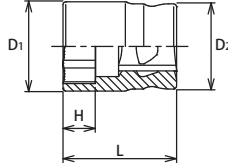

4400MZ (mm)	D ₁ (mm)	D ₂ (mm)	H (mm)	L (mm)	(g)	(pcs.)
8	12.9	20.6	4.5	26	30	10
10	15	20.6	4.5	26	31	10
12	17	20.6	5.5	27	32	10
13	18.3	21.5	6.5	28	40	10
14	19.5	21.5	6.5	28	40	10
16	22	21.5	7.5	29	43	10
17	23	22.5	7.5	29	49	10
18	24.1	23.7	7.5	29	56	10
19	25.3	24.4	9.5	29	62	10
21	27.6	26.3	10.5	29	76	10
22	28.8	27.5	11	29	83	10
24	31.1	29.2	12	29	96	5
27	34.6	32.2	13.5	30	124	5
30	38.1	35.2	14.5	31	156	5
32	40.4	36.8	15.5	32	178	5

RS4400MZ/10

Socket Set on magnetic Rail
Steckschlüsselsatz auf Magnetschiene
Jeu de douilles sur rail à aimant



RS4400MZ/10	10 Pieces Set/Rail 300mm	(g)
10, 12, 13, 14, 17, 19, 21, 22, 24, 27		830

4725Z

Reversible Ratchet
Knarre, verstellbar
Cliquet, réversible

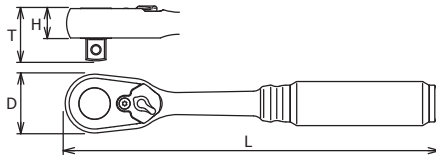

72

	D (mm)	T (mm)	H (mm)	L (mm)	(g)	(pce.)
4725Z	36.5	32.8	18.2	253	590	1

* Renewal Kits → 4725BRK-2 → P320

4725ZB

Reversible Ratchet with Quick Release Button
Knarre, verstellbar mit Entriegelungsknopf
Cliquet, réversible avec bouton de débrayage

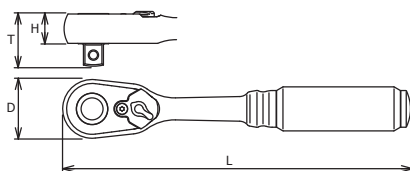

72



	D (mm)	T (mm)	H (mm)	L (mm)	(g)	(pce.)
New 4725ZB	36.5	32.8	18.2	253	595	1

* Renewal Kits → 4725BRK-1 → P320

Z-SERIES

HAND

TITANIUM

SCREWDRIVERS ACCESSORIES

IMPACT

SLEEVE-DRIVE

PROTECTOR

INDUSTRIAL

AUTOMOTIVE

MOTORCYCLE

CONSTRUCTION

SPARE PART

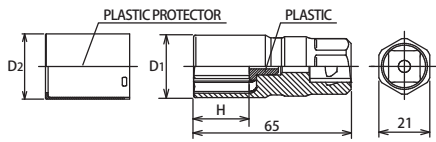

4300PMZ-65

Wheel Nut Socket with Plastic Protector
Radnutttern Steckschlüssel mit Kunststoff Hülse
Douilles pour écrous de roue avec protection en plastique



4300PMZ-65 (mm)	D ₁ (mm)	D ₂ (mm)	H (mm)	Shaft Colour	(g)	(pcs.)
17	23.7	25.2	21	Blue	135	10
19	25.7	27.2	23	Red	150	10
21	27.5	29	25	Yellow	155	10
22	29	30.5	26	White	165	10

New Please note that thin walled design is only for wheel nut work and Torque rating is limited.



FREE-TURN
CROSS WRENCH

4711XZ

Spinning Cross Wrench
T-Griff für die Radmuttermontage
Poignée coulissante pour montage des écrous à roue

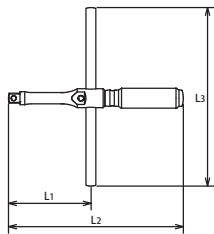

	L1 (mm)	L2 (mm)	L3 (mm)	(g)	(pce.)
4711XZ	133	264	350	915	1



RENEWAL KIT FOR
HINGE HANDLE

OVAL SHAPE
SHANK

4768Z-430

Hinge Handle
Gelenkgriff
Poignée articulée



	D (mm)	L (mm)	(g)	(pce.)
4768Z-430	28	430	720	2

* Renewal Kits → 4768ZRK → P321

Warning 4768Z-430 have longer handle than standard, and can be loaded to excessive torque value. In the interest of your own safety always apply load evenly and progressively to avoid breakage and possible injury.

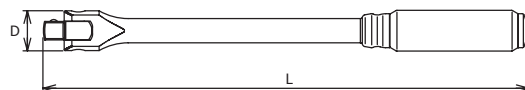

4760Z

Extension Bars
Verlängerungen
Rallonges

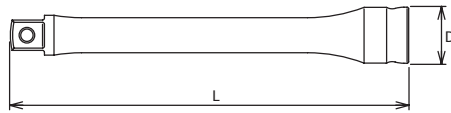

	D (mm)	L (mm)	(g)	(pcs.)
4760Z-125	23	125	180	5
4760Z-250	23	250	340	5

4760LZ

Locking Extension Bars
Verriegelbare Verlängerungen
Barres d'extension verrouillables

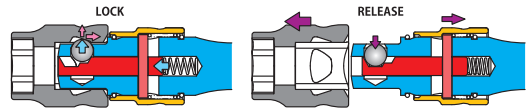
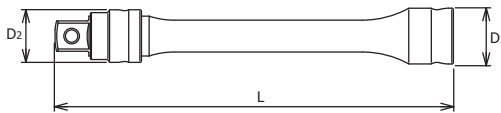

	D ₁ (mm)	D ₂ (mm)	L (mm)	(g)	(pcs.)
New 4760LZ-125	23	20.5	125	186	5
New 4760LZ-250	23	20.5	250	346	5



You may not hold the sliding part while moving to avoid heating up by friction and reduction by wear.

Bitte das gleitende Teil während der Bewegung nicht festhalten, um eine Erhitzung durch Reibung und durch Verschleiß zu vermeiden.

Veuillez ne pas tenir la pièce coulissante pendant le mouvement, afin d'éviter un échauffement dû à la friction et à l'usure.

4771Z

Universal Joint
Gelenk-Einsatz
Joint articulé



UNIVERSAL JOINT

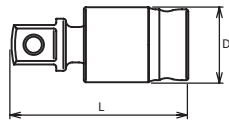
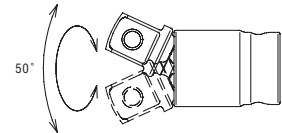

	D (mm)	L (mm)	(g)	(pcs.)
4771Z	23.7	55.8	100	10

1/2"

Z-series
Z-serie
Series-Z

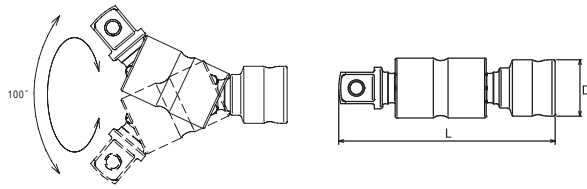

	D (mm)	L (mm)	(g)	(pcs.)
4772Z	23.7	87.2	170	5

4772Z Universal Double Joint
Doppelgelenk-Einsatz
Joint articulé double



RSX772Z/3	3 Pieces Set/Rail 200mm	(g)
2772Z, 3772Z, 4772Z		290

1/4" + 3/8" + 1/2"

RSX772Z/3

Universal Joints 1/4", 3/8", 1/2" 3 pcs set on rail
Doppelgelenk-Einsätze 1/4", 3/8", 1/2" 3teiliger Satz auf Schiene
Douilles à double articulation 1/4", 3/8", 1/2" Jeu de 3 pièces sur rail



	D (mm)	L (mm)	(g)	(pcs.)
4756Z	36.3	33.5	84	10

4756Z Quick Spinner
Rändel-Drehscheibe
Lanceur

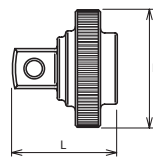

Z-SERIES

HAND

TITANIUM

ACCESSORIES

SCREWDRIVERS

IMPACT

SLEEVE-DRIVE

PROTECTOR

INDUSTRIAL

AUTOMOTIVE

MOTORCYCLE

CONSTRUCTION

SPARE PART

4285Z Set in Foam tray
Steckschlüsselsatz in Weichschaumeinlage
Set disposé dans boîte de rangement en mousse souple



4285Z 21 Pieces Set/△=4,800g

METAL CASE:W445xT190xH50

Sockets		Accessories	
4400MZ 6-pt. Sockets 8, 10, 12, 13, 14, 16, 17, 18, 19, 21, 22, 24, 27, 30, 32			4725Z
			4756Z
			4771Z
			4768Z-430
			4760Z-125
			4760Z-250

4285ZE Socket Sets
Steckschlüssel Sätze
Jeu de clés à douilles



4285ZE 11 Pieces Set/△=1,380g

Rail 300mm/PLASTIC BAG

Sockets		Accessories	
4400MZ 6-pt. Sockets 10, 12, 13, 14, 17, 19, 21,22, 24			4725Z
			4756Z

RSAL200 Magnetic Rail with retaining clips
Magnetschiene mit Halteklammern
RSAL300 Rail à aimant avec clips de maintien



RSAL200		RAIL (mm)	CLIP (pcs.)	(g)	(pce.)
1/4x12	1/4"	200	12	125	1
3/8x8	3/8"	200	8	130	1

RSAL300		RAIL (mm)	CLIP (pcs.)	(g)	(pce.)
3/8x12	3/8"	300	12	180	1
1/2x10	1/2"	300	10	190	1

RSAL CLIP.P/5 Magnetic Rails and retaining Clips, bulk
Magnetschiene und Halteklammern, lose
Rail à aimant avec clips de maintien, en vrac



RAIL

	RAIL (mm)	(g)	(pce.)
RSAL200	200	110	1
RSAL300	300	145	1
RSAL400	400	210	1

CLIP

CLIP.P/5		(g)	(pce.)
1/4	1/4"	10	5
3/8	3/8"	13	5
1/2	1/2"	20	5