

**Z-SERIES
Z-SERIE
SERIES-Z**

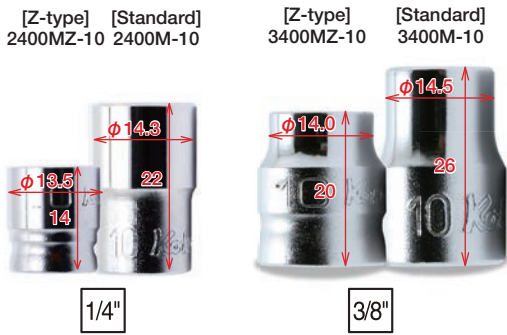

Z-Series : Feature



COMPACT

2400MZ and 3400MZ are designed 5-9mm shorter than standard 2400M and 3400M which is ideal for working in confined and tight areas.

2400MZ und 3400MZ sind gegenüber unseren Standardausführungen 2400M und 3400M um 5-9mm kürzer. Dies erlaubt ein Arbeiten an schwer zugänglichen Stellen.

Les douilles 2400MZ et 3400MZ étant plus courtes de 5-9mm par rapport aux douilles standards, elles ont l'avantage de faciliter le travail dans des endroits étroits et difficilement accessibles.

TOLERANCE-Hexagon Opening

The Hexagon openings of our Z-Sockets are produced with reduced tolerances (according to DIN/ISO) which achieve a more positive fit between bolt and socket.

Die Steckschlüsselöffnungen der Z-Serie werden mit geringeren Toleranzen (nach DIN/ISO) gefertigt um eine bessere, direktere Verbindung zwischen Schraube und Werkzeug zu gewährleisten.

Les douilles Ko-ken de la série Z sont fabriquées selon DIN/ISO comme toutes les douilles standards. Sauf que pour la série Z les tolérances sont plus restreintes afin d'atteindre un meilleur ajustement entre douille et vis.

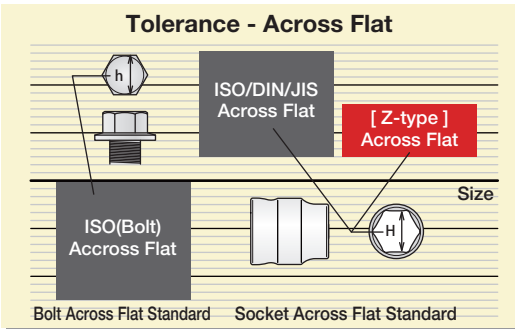

TOLERANCE-Square Drive

To ensure a tighter fit between socket and handle, the male and female square drives are produced with shorter tolerances (according DIN/ISO).

Auch die Antriebsvierkante sind mit einer geringeren Toleranz (nach DIN/ISO) gefertigt um eine festere Verbindung zwischen Betätigungswerkzeug und Steckschlüssel zu ermöglichen.

Aussi les carrés mâles et femelles sont fabriqués avec des tolérances plus restreintes (selon DIN/ISO) afin de garantir une meilleure fixation entre cliquet et douille.

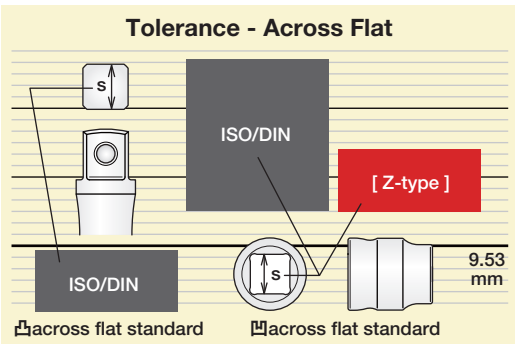

BALL HOLDING GROOVE

The inventive Ball Holding system of the Z-series allows a secure connection between Socket and Handle.

Die Werkzeuge der Z-Serie verfügen über spezielle Kugelfangrillen, die eine noch sicherere Verbindung zwischen Betätigungswerkzeug und Steckschlüssel gewährleisten.

La série Z dispose d'une rainure de fixation pour bille spéciale, qui améliore nettement la fixation entre douille et cliquet.

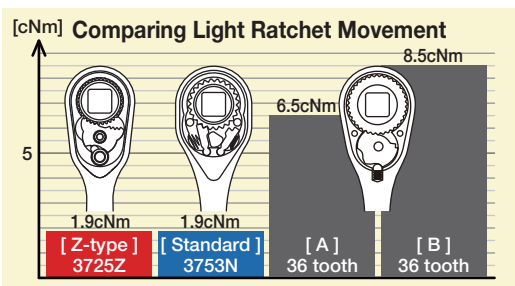
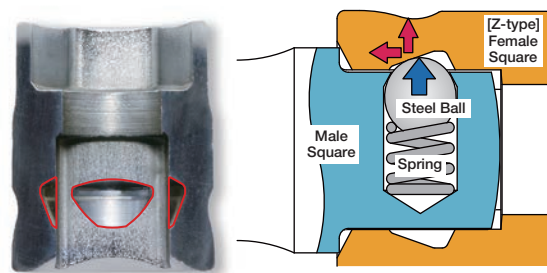

* A, B : Other Brand

2400MZ (mm)	D ₁ (mm)	D ₂ (mm)	ℓ (mm)	L (mm)	(g)	(pcs.)
4	6.4	11	3	14	6	10
4.5	7	11	3	14	6	10
5	7.6	11	3	14	6	10
5.5	8.2	11	3.5	14	6	10
6	8.8	11	3.5	14	6	10
7	9.9	11	3.5	14	6	10
8	11.1	11.7	4.5	15	7	10
10	13.5	12.5	7	15	8	10
11	14.7	13.2	7	15	9	10
12	15.9	14.4	7	15	11	10
13	17.1	15.6	7	15	14	10
14	18.3	16.8	7	15	16	10

RS2400MZ/12	12 Pieces Set/Rail 200mm	(g)
4, 4.5, 5, 5.5, 6, 7, 8, 10, 11, 12, 13, 14		228

2300XZ (mm)	D ₁ (mm)	D ₂ (mm)	ℓ (mm)	H (mm)	L (mm)	(g)	(pcs.)
5.5	8.2	11	6	20	30	10	10
6	8.8	11	7	20	30	10	10
7	9.9	11	8	20	30	11	10
8	11.1	11.7	9	20	30	13	10
10	13.5	12.5	11	20	30	16	10
11	14.7	13.2	12	20	30	19	10
12	15.9	14.4	13	20	30	22	10
13	17.1	15.6	14	20	30	26	10
14	18.3	16.8	14	20	30	30	10

RS2300XZ/9	9 Pieces Set/Rail 200mm	(g)
5.5, 6, 7, 8, 10, 11, 12, 13, 14		290

2300MZ (mm)	D ₁ (mm)	D ₂ (mm)	ℓ (mm)	H (mm)	L (mm)	(g)	(pcs.)
4	6.4	11	5	41	50	14	10
4.5	7	11	5.5	41	50	16	10
5	7.6	11	6	41	50	16	10
5.5	8.2	11	6.5	41	50	16	10
6	8.8	11	7	41	50	17	10
7	9.9	11	8	41	50	20	10
8	11.1	11.7	9	41	50	22	10
10	13.5	12.5	11	41	50	29	10
11	14.7	13.2	12	41	50	33	10
12	15.9	14.4	13	41	50	40	10
13	17.1	15.6	14	41	50	45	10
14	18.3	16.8	16	41	50	51	10

RS2300MZ/12	12 Pieces Set/Rail 200mm	(g)
4, 4.5, 5, 5.5, 6, 7, 8, 10, 11, 12, 13, 14		445

2400MZ 6-point Sockets 6-kant Steckschlüssel Douilles 6-pans

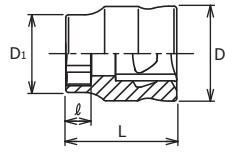

RS2400MZ/12 Socket Set on magnetic Rail Steckschlüsselsatz auf Magnetschiene Jeu de douilles sur rail à aimant



2300XZ 6-point Sockets, Semi-Deep 6-kant Steckschlüssel, mittel-lang Douilles, semi-profondes 6-pans

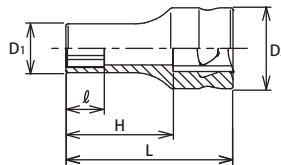

RS2300XZ/9 Socket Set on magnetic Rail Steckschlüsselsatz auf Magnetschiene Jeu de douilles sur rail à aimant

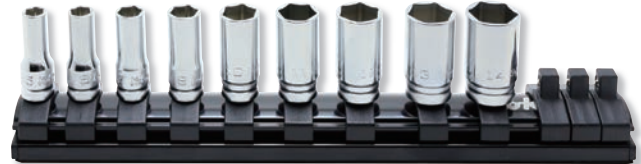

2300MZ 6-point Deep Sockets 6-kant-Steckschlüssel, lang Douilles longues 6-pans

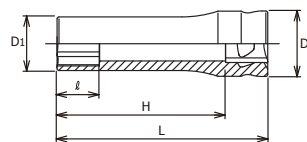

RS2300MZ/12 Socket Set on magnetic Rail Steckschlüsselsatz auf Magnetschiene Jeu de douilles sur rail à aimant



Z-SERIES
HAND
TITANIUM
SCREWDRIVERS
ACCESSORIES
IMPACT
SLEEVE-DRIVE
PROTECTOR
INDUSTRIAL
AUTOMOTIVE
MOTORCYCLE
CONSTRUCTION
SPARE PART

2000Z-28/-50

 Phillips Bit Sockets
Steckschlüssel für Kreuzschlitzschrauben Phillips
Douilles tournevis pour vis à empreinte Phillips

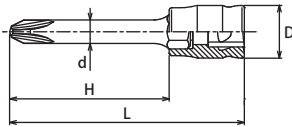

2000Z-28 (PH)	D (mm)	H (mm)	L (mm)	(g)	(pcs.)
1	11.2	12	28	9	10
2	11.2	12	28	10	10
3	11.2	12	28	10	10

2000Z-50 (PH)	D (mm)	d (mm)	H (mm)	L (mm)	(g)	(pcs.)
1	11.2	4	34	50	11	10
2	11.2	5	34	50	13	10
3	11.2	-	34	50	16	10

2005Z-25

 Bit Sockets for Slotted Head
Steckschlüssel für Schlitzschrauben
Douilles tournevis pour vis à fente

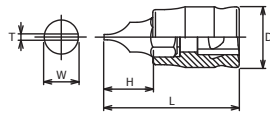

2005Z-25	T x W (mm)	D (mm)	H (mm)	L (mm)	(g)	(pcs.)
5	1.0 x 5.5	11.2	9	25	9	10
6	1.2 x 6.5	11.2	9	25	10	10

2010MZ-25/-50



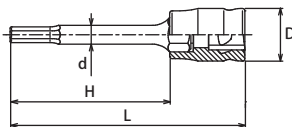

 Inhex Bit Sockets
Steckschlüssel für Innensechskant-Schrauben
Douilles tournevis pour vis 6-pans creux



2010MZ-25 (mm)	D (mm)	H (mm)	L (mm)	(g)	(pcs.)
3	11.2	9	25	9	10
4	11.2	9	25	9	10
5	11.2	9	25	10	10
6	11.2	9	25	10	10

2010MZ-50 (mm)	D (mm)	d (mm)	H (mm)	L (mm)	(g)	(pcs.)
3	11.2	4	34	50	11	10
4	11.2	5	34	50	13	10
5	11.2	6	34	50	15	10
6	11.2	-	34	50	17	10

RS20XXZ/9

     Socket Set on magnetic Rail
Steckschlüsselsatz auf Magnetschiene
Jeu de douilles sur rail à aimant



RS20XXZ/9		9 Pieces Set/Rail 200mm	(g)
2000Z.28		1, 2, 3	213
2005Z.25		5, 6	
2010MZ.25		3, 4, 5, 6	

1/4"

Z-series
Z-serie
Series-Z

2025Z-28 (T)	D (mm)	H (mm)	L (mm)	(g)	(pcs.)
T10	11.2	12	28	9	10
T15	11.2	12	28	9	10
T20	11.2	12	28	9	10
T25	11.2	12	28	10	10
T27	11.2	12	28	10	10
T30	11.2	12	28	10	10
T40	11.2	12	28	11	10

2025Z-50 (T)	D (mm)	d (mm)	H (mm)	L (mm)	(g)	(pcs.)
T10	11.2	4	34	50	11	10
T15	11.2	4	34	50	11	10
T20	11.2	4.5	34	50	12	10
T25	11.2	5	34	50	13	10
T27	11.2	5	34	50	13	10
T30	11.2	5.6	34	50	15	10
T40	11.2	-	34	50	17	10

2025Z-28/-50

 TORX® Bit Sockets
TORX® Bit-Steckschlüssel
Douilles tournevis, TORX®

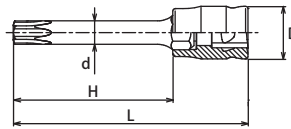

RS2025Z/7-L28	7 Pieces Set/Rail 200mm	(g)
T10, T15, T20, T25, T27, T30, T40		195

RS2025Z/7-L50	7 Pieces Set/Rail 200mm	(g)
T10, T15, T20, T25, T27, T30, T40		220

RS2025Z/7-L28 RS2025Z/7-L50

 Socket Set on magnetic Rail
Steckschlüsselsatz auf Magnetschiene
Jeu de douilles sur rail à aimant



2725Z 2725Z-160

Reversible Ratchet
Knarre, verstellbar
Cliquet, réversible

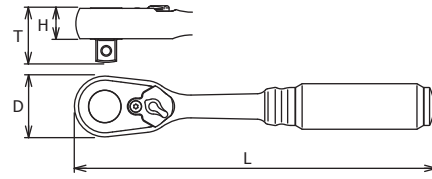

36

	D (mm)	T (mm)	H (mm)	L (mm)	(g)	(pcs.)
2725Z	20.5	17.1	9.5	114	79	2
New 2725Z-160	20.5	17.1	9.5	160	120	1

* Renewal Kits → 2725RK → P298

2726Z 2726Z-160

Flexible Ratchet, Reversible (Short)
Gelenk-Knarre kurz, verstellbar
Cliquet articulé court, réversible

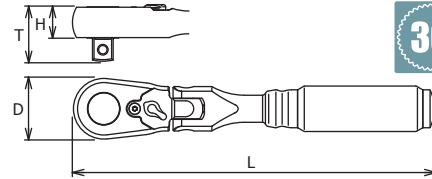

36
Flexible Head

	D (mm)	T (mm)	H (mm)	L (mm)	(g)	(pcs.)
2726Z	20.5	17.1	9.5	114	103	2
New 2726Z-160	20.5	17.1	9.5	160	150	1

* Renewal Kits → 2725RK → P298

2760Z

Extension Bars
Verlängerungen
Rallonges

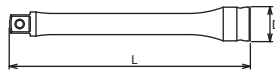

2760Z	D (mm)	L (mm)	(g)	(pcs.)
50	11.5	50	21	10
100	11.5	100	39	10
150	11.5	150	58	10

2771Z

Universal Joint
Gelenk-Einsatz
Joint articlé

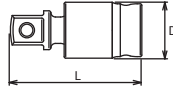

2771Z	D (mm)	L (mm)	(g)	(pcs.)
2771Z	11.7	29.9	15	10

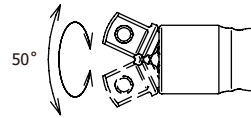

2772Z

Universal Double Joint
Doppelgelenk-Einsatz
Joint articlé double

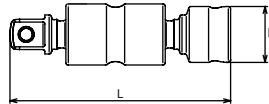

New 2772Z	D (mm)	L (mm)	(g)	(pcs.)
2772Z	11.7	46	26	10

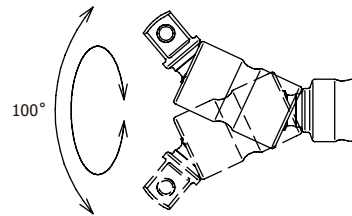

2756Z

Quick Spinner
Rändel-Drehscheibe
Lanceur

2756Z-3/8







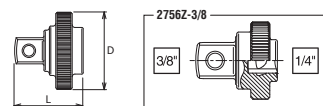

Quick Spinner, Adaptor
Rändel-Drehscheibe als Adaptor
Lanceur, adaptateur



2756Z-3/8



	D (mm)	L (mm)	(g)	(pcs.)
2756Z	20.3	18	15	10
2756Z-3/8	20.3	21.5	24	10



P2285Z		26 Pieces Set/△=660g	
PLASTIC CASE:W245xH120xT45			
Sockets	Accessories		
 2400MZ 6-pt. Sockets 4, 4.5, 5, 5.5, 6, 7, 8, 10, 11,12, 13, 14		2725Z	
		2756Z	
 2000Z.28 1, 2, 3		2771Z	
 2005Z.25 5, 6		2760Z-50	
 2010MZ.25 3, 4, 5, 6		2760Z-150	







P2285Z Set in PE-foam tray
Steckschlüsselsatz in Weichschaumeinlage
Set disposé dans boîte de rangement en mousse souple



2285ZE		10 Pieces Set/△=300g	
Rail 200mm/PLASTIC BAG			
Sockets	Accessories		
 2400MZ 6-pt. Sockets 5.5, 6, 7, 8, 10, 12, 13, 14		2725Z	
		2756Z	

2285ZE Socket Sets
Steckschlüssel Sätze
Jeu de clés à douilles

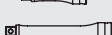

New 2286Z		17 Pieces Set/△=780g	
BLACK METAL CASE:W240xH100xT32mm			
Sockets	Accessories		
 2400MZ 6-pt. Sockets 4, 5, 5.5, 6, 7, 8, 10, 11, 12, 13, 14		2725Z	
		2756Z	
		2771Z	
		2760Z-50	
		2760Z-100	
		2760Z-150	

2286Z Set in PE-foam tray
Steckschlüsselsatz in Weichschaumeinlage
Set disposé dans boîte de rangement en mousse souple



3400MZ

6-point Sockets
6-kant Steckschlüssel
Douilles 6-pans

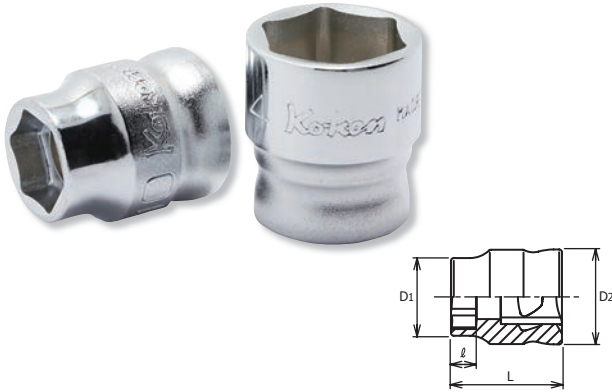

3400MZ (mm)	D ₁ (mm)	D ₂ (mm)	ℓ (mm)	L (mm)	(g)	(pcs.)
5.5	8.5	17	3.5	19	16	10
6	9.1	17	3.5	19	17	10
7	10.3	17	3.5	19	17	10
8	11.5	17	4.5	20	17	10
10	14	17	4.5	20	18	10
11	15.3	17	5.5	21	18	10
12	16.5	17	5.5	21	19	10
13	17.8	17	8.5	21	19	10
14	19	17	8.5	21	20	10
15	20.2	18.2	8.5	21	24	10
16	21.3	19.3	8.5	21	28	10
17	22.5	20.5	8.5	21	32	10
18	23.6	21.6	9.5	22	38	10
19	24.8	22.8	9.5	22	41	10
21	27	25	10.5	23	51	10
22	28.3	26.3	10.5	23	58	10

3400MZ is designed 5-9mm shorter than standard 3400M.
Ideal for working in confined and tight areas.

RS3400MZ/8 RS3400MZ/12

Socket Set on magnetic Rail
Steckschlüsselsatz auf Magnetschiene
Jeu de douilles sur rail à aimant



RS3400MZ/8	8 Pieces Set/Rail 200mm	(g)
8, 10, 11, 12, 13, 14, 17, 19		320

RS3400MZ/12	12 Pieces Set/Rail 300mm	(g)
7, 8, 10, 11, 12, 13, 14, 15, 16, 17, 18, 19		490

3300XZ

6-point Sockets, Semi-Deep
6-kant Steckschlüssel, mittel-lang
Douilles, semi-profondes 6-pans

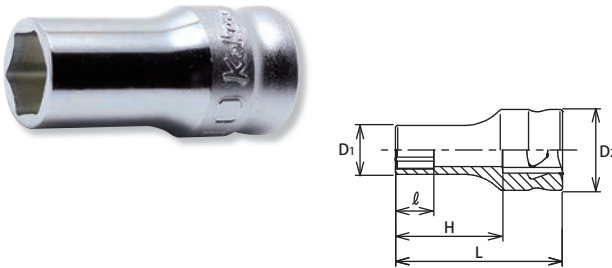

3300XZ (mm)	D ₁ (mm)	D ₂ (mm)	ℓ (mm)	H (mm)	L (mm)	(g)	(pcs.)
7	10.3	17	8	23	35	23	10
8	11.5	17	9	23	35	24	10
10	14	17	11	23	35	26	10
11	15.3	17	12	23	35	28	10
12	16.5	17	13	23	35	29	10
13	17.8	17	14	23	35	32	10
14	19	17	16	23	35	34	10
15	20.2	18.2	16	23	35	40	10
16	21.3	19.3	16.5	23	35	45	10
17	22.5	20.5	16.5	23	35	50	10
18	23.6	21.6	16.5	23	35	56	10
19	24.8	22.8	18	23	35	60	10

RS3300XZ/8 RS3300XZ/12

Socket Set on magnetic Rail
Steckschlüsselsatz auf Magnetschiene
Jeu de douilles sur rail à aimant



RS3300XZ/8	8 Pieces Set/Rail 200mm	(g)
8, 10, 11, 12, 13, 14, 17, 19		420

RS3300XZ/12	12 Pieces Set/Rail 300mm	(g)
7, 8, 10, 11, 12, 13, 14, 15, 16, 17, 18, 19		630

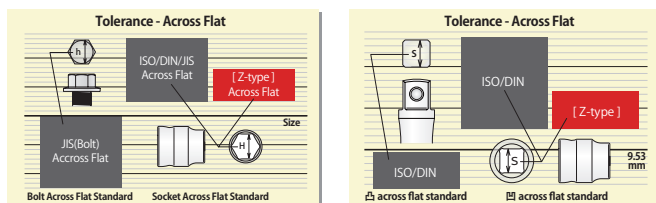

Manufacturing tolerance is precisely controlled to achieve a secure fitting.

BALL HOLDING GROOVE

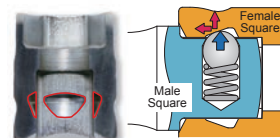

The inventive Ball Holding system of the Z-series allows a secure connection between Socket and Handle.

Die Werkzeuge der Z-Serie verfügen über spezielle Kugelfangrillen, die eine noch sicherere Verbindung zwischen Betätigungswerkzeug und Steckschlüssel gewährleisten.

La série Z dispose d'une rainure de fixation pour bille spéciale, qui améliore nettement la fixation entre douille et cliquet.

3/8"

Z-series
Z-serie
Series-Z

3300MZ (mm)	D ₁ (mm)	D ₂ (mm)	ℓ (mm)	H (mm)	L (mm)	(g)	(pcs.)
7	10.3	17	8	41.5	55	29	10
8	11.5	17	9	41.5	55	34	10
10	14	17	11	41.5	55	43	10
11	15.3	17	12	41.5	55	45	10
12	16.5	17	13	41.5	55	49	10
13	17.8	17	14	41.5	55	52	10
14	19	17	16	41.5	55	55	10
15	20.2	18.2	16	40.5	55	65	10
16	21.3	19.3	17	40.5	55	74	10
17	22.5	20.5	18	40.5	55	83	10
18	23.6	21.6	19	39.5	55	90	10
19	24.8	22.8	20	39.5	55	95	10

RS3300MZ/8	8 Pieces Set/Rail 200mm	(g)
8, 10, 11, 12, 13, 14, 17, 19		600

RS3300MZ/12	12 Pieces Set/Rail 300mm	(g)
7, 8, 10, 11, 12, 13, 14, 15, 16, 17, 18, 19		900

RS3X00MZ/12	12 Pieces Set/Rail 300mm	(g)
3400MZ	8, 10, 11, 12, 13, 14, 17, 19	550
3300MZ	8, 10, 12, 14	

3300CZ (mm)	D (mm)	ℓ (mm)	L (mm)	(g)	(pcs.)
14	18.4	11	70	67	10
16	20.5	13	70	71	10
18	22.9	12	70	75	10
20.8	26.3	13.5	70	105	10

Slim & light weight body with smaller outside diameter for work in tight spaces.

3305PZ (mm)	D (mm)	ℓ (mm)	L (mm)	(g)	(pcs.)
14	17.9	8	70	56	10
16	20	8	70	55	10

Spark Plug Socket with Magnet, 12-pt. opening: size 14mm



3300MZ 6-point Deep Sockets
6-kant-Steckschlüssel,lang
Douilles longues 6-pans

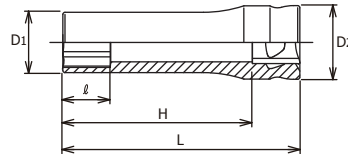

RS3300MZ/8 Socket Set on magnetic Rail
Steckschlüsselsatz auf Magnetschiene
RS3300MZ/12
Jeu de douilles sur rail à aimant



RS3X00MZ/12 Socket Set on magnetic Rail
Steckschlüsselsatz auf Magnetschiene
Jeu de douilles sur rail à aimant



3300CZ Spark Plug Sockets with Spring Clips
Zündkerzen-Schlüssel mit Haltefeder
Douilles avec ressorts de retenues pour bougies

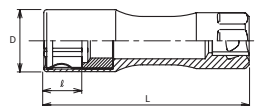

3305PZ Spark Plug Socket with Magnet, 12-pt. opening
Zündkerzensteckschlüssel mit Magnet, 12-kant
Douille pour bougies, avec aimant, 12-pans

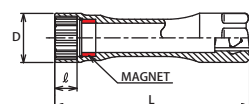

3010MZ-50/-75

 Inhex Bit Sockets
Steckschlüssel für Innensechskant-Schrauben
Douilles tournevis pour vis 6-pans creux

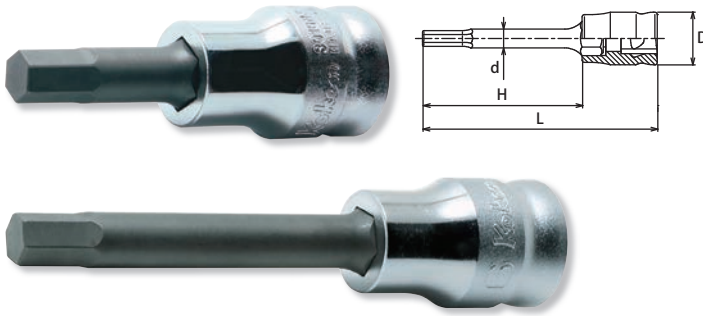

3010MZ-50 (mm)	D (mm)	d (mm)	H (mm)	L (mm)	(g)	(pcs.)
3	17	4	23.5	50	28	10
4	17	5	23.5	50	29	10
5	17	6	23.5	50	30	10
6	17	7	23.5	50	35	10
7	17	-	23.5	50	38	10
8	17	-	23.5	50	40	10
10	17	-	23.5	50	50	10
12	19	-	23.5	50	70	10

3010MZ-75 (mm)	D (mm)	d (mm)	H (mm)	L (mm)	(g)	(pcs.)
3	17	6	48.5	75	33	10
4	17	6	48.5	75	35	10
5	17	6	48.5	75	36	10
6	17	7	48.5	75	41	10
7	17	7.9	48.5	75	45	10
8	17	-	48.5	75	48	10
10	17	-	48.5	75	65	10
12	19	-	48.5	75	90	10

RS3010MZ/8-L50 RS3010MZ/8-L75

 Socket Set on magnetic Rail
Steckschlüsselsatz auf Magnetschiene
Jeu de douilles sur rail à aimant



RS3010MZ/8-L50	8 Pieces Set/Rail 200mm	(g)
3, 4, 5, 6, 7, 8, 10, 12		460

RS3010MZ/8-L75	8 Pieces Set/Rail 200mm	(g)
3, 4, 5, 6, 7, 8, 10, 12		530

3025Z-50/-75

 TORX® Bit Sockets
TORX® Bit-Steckschlüssel
Douilles tournevis, TORX®

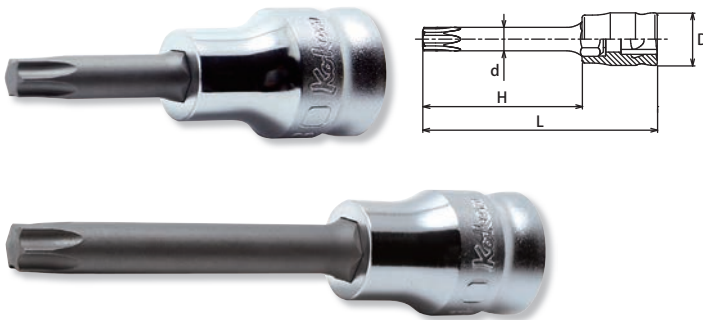

3025Z-50 (T)	D (mm)	d (mm)	H (mm)	L (mm)	(g)	(pcs.)
T10	17	3	23.5	50	27	10
T15	17	3.5	23.5	50	28	10
T20	17	3.9	23.5	50	28	10
T25	17	4.5	23.5	50	29	10
T27	17	5	23.5	50	30	10
T30	17	5.6	23.5	50	31	10
T40	17	6.7	23.5	50	35	10
T45	17	7.83	23.5	50	38	10
T50	17	8.90	23.5	50	48	10
T55	19	11.3	23.5	50	70	10

3025Z-75 (T)	D (mm)	d (mm)	H (mm)	L (mm)	(g)	(pcs.)
T20	17	4.5	48.5	75	32	10
T25	17	5	48.5	75	33	10
T27	17	5	48.5	75	33	10
T30	17	5.6	48.5	75	35	10
T40	17	6.7	48.5	75	41	10
T45	17	7.9	48.5	75	45	10
T50	17	8.9	48.5	75	55	10
T55	19	11.3	48.5	75	80	10

RS3025Z/8-L50 RS3025Z/8-L75

 Socket Set on magnetic Rail
Steckschlüsselsatz auf Magnetschiene
Jeu de douilles sur rail à aimant



RS3025Z/8-L50	8 Pieces Set/Rail 200mm	(g)
T20, T25, T27, T30, T40, T45, T50, T55		450

RS3025Z/8-L75	8 Pieces Set/Rail 200mm	(g)
T20, T25, T27, T30, T40, T45, T50, T55		480

3/8"

Z-series
Z-serie
Series-Z

Z-SERIES
HAND
TITANIUM
ACCESSORIES
SCREWDRIVERS
IMPACT
SLEEVE-DRIVE
PROTECTOR
INDUSTRIAL
AUTOMOTIVE
MOTORCYCLE
CONSTRUCTION
SPARE PART

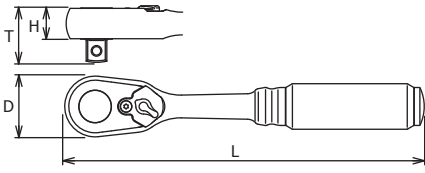

36

	D (mm)	T (mm)	H (mm)	L (mm)	(g)	(pcs.)
2725Z-3/8	20.5	20.5	9.5	114	83	2

2725Z-3/8 Reversible Ratchet Short
Knarre kurz, verstellbar
Cliquet court, réversible

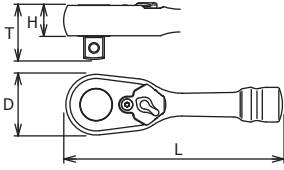

36

	D (mm)	T (mm)	H (mm)	L (mm)	(g)	(pcs.)
3725ZS	28	24.5	13.7	100	157	2

* Renewal Kits → 3725RK → P298

3725ZS Reversible Ratchet Short
Knarre kurz, verstellbar
Cliquet court, réversible

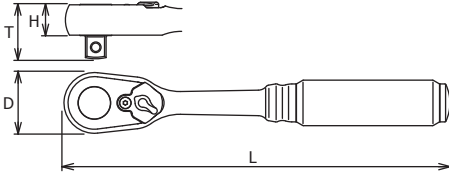

36

	D (mm)	T (mm)	H (mm)	L (mm)	(g)	(pcs.)
3725Z	28	24.5	13.7	178	254	1
New 3725Z-280	28	24.5	13.7	280	360	1

* Renewal Kits → 3725RK → P298

3725Z
3725Z-280 Reversible Ratchet
Knarre, verstellbar
Cliquet, réversible

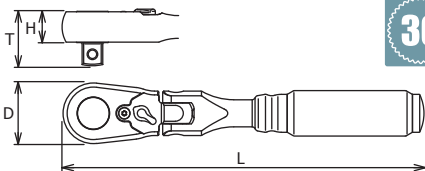

36 Flexible Head

	D (mm)	T (mm)	H (mm)	L (mm)	(g)	(pcs.)
2726Z-3/8	20.5	20.5	9.5	114	107	2

2726Z-3/8 Flexible Ratchet, Reversible (Short)
Gelenk-Knarre kurz, verstellbar
Cliquet articulé court, réversible



Z-SERIES
HAND
TITANIUM
SCREWDRIVERS ACCESSORIES
IMPACT
SLEEVE-DRIVE
PROTECTOR
INDUSTRIAL
AUTOMOTIVE
MOTORCYCLE
CONSTRUCTION
SPARE PART

3726ZS

Flexible Ratchet, Reversible (Short)
Gelenk-Knarre kurz, verstellbar
Cliquet articulé court, réversible

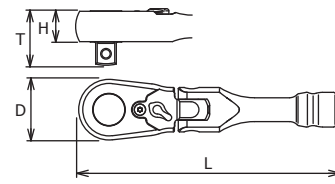

	D (mm)	T (mm)	H (mm)	L (mm)	(g)	(pcs.)
3726ZS	28	24.5	13.7	120	196	2

* Renewal Kits → 3725RK → P298

3726Z

3726Z-280

Flexible Ratchet, Reversible
Gelenk-Knarre, verstellbar
Cliquet articulé, réversible

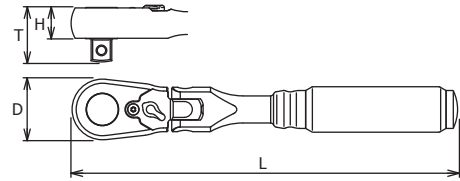

	D (mm)	T (mm)	H (mm)	L (mm)	(g)	(pcs.)
3726Z	28	24.5	13.7	178	317	1
New 3726Z-280	28	24.5	13.7	280	420	1

* Renewal Kits → 3725RK → P298

3768Z-250/-400

Hinge Handle
Gelenkgriff
Poignée articulée

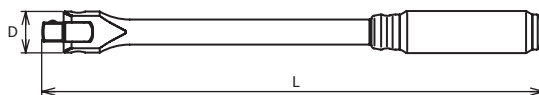

	D (mm)	L (mm)	(g)	(pcs.)
3768Z				
250	20.5	250	309	2
New 400	20.5	400	500	2

* Renewal Kits → 3768ZRK → P300

3760Z-75/-125/-250

Extension Bars
Verlängerungen
Rallonges

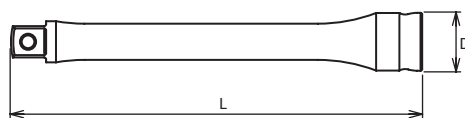

	D (mm)	L (mm)	(g)	(pcs.)
3760Z				
75	17.5	75	66	10
125	17.5	125	103	10
250	17.5	250	195	5

	D (mm)	L (mm)	(g)	(pcs.)
3771Z	18	42.5	44	10

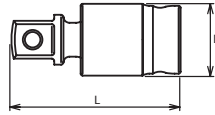
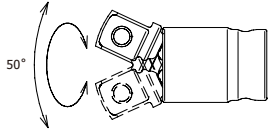

3771Z Universal Joint
Gelenk-Einsatz
Joint articlé

	D (mm)	L (mm)	(g)	(pcs.)
New 3772Z	17	65	76	10

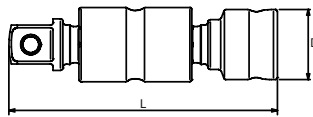
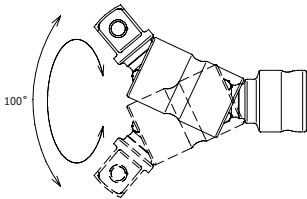

3772Z Universal Double Joint
Doppelgelenk-Einsatz
Joint articlé double

	D (mm)	L (mm)	(g)	(pcs.)
3756Z	28	25	40	10

Outside diameter is smaller compared to standard 3756.
Ideal for working in combination with 3725Z



3756Z Quick Spinner
Rändel-Drehscheibe
Lanceur

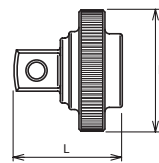

	D (mm)	L (mm)	(g)	(pcs.)
New 3756ZS	20.3	25	26	10

Ideal for working in combination with 2725Z-3/8 and 2726Z-3/8.

3756ZS Quick Spinner
Rändel-Drehscheibe
Lanceur

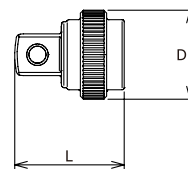

	D (mm)	L (mm)	(g)	(pcs.)
3322AZ-75	17.5	75	42	10

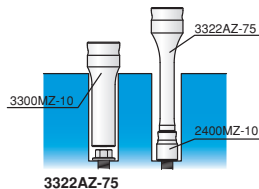

3322AZ-75 Extension Adaptor
Verlängerungsadaptor
Reduction adapteur-rallonge

New **3286Z** 21 Pieces Set/⚖️=2,600g

BLACK METAL CASE:W415xH120xT50mm

Sockets	Accessories
3400MZ 6-pt. Sockets 7, 8, 10, 11, 12, 13, 14, 15, 16, 17, 18, 19, 21, 22	3725Z 3756Z 3771Z 3768Z-250 3760Z-75 3760Z-125 3760Z-250

3286Z Set in PE-foam tray
Steckschlüsselsatz in Weichschaumeinlage
Set disposé dans boîte de rangement en mousse souple



3285Z Set in PE-foam tray
Steckschlüsselsatz in Weichschaumeinlage
Set disposé dans boîte de rangement en mousse souple



3285ZA Set in PE-foam tray
Steckschlüsselsatz in Weichschaumeinlage
Set disposé dans boîte de rangement en mousse souple



3285ZE Socket Sets
Steckschlüssel Sätze
Jeu de clés à douilles













RSAL200-1/4x12/-3/8x8  Magnetic Rail with retaining clips
RSAL300-3/8x12/-1/2x10 Magnetschiene mit Halteklammern
Rail à aimant avec clips de maintien





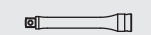

RSAL-200/-300/-400 Magnetic Rails and retaining Clips, bulk
CLIP.P/5-1/4/-3/8/-1/2 Magnetschiene und Halteklammern, lose
Rail à aimant avec clips de maintien, en vrac





3285Z 26 Pieces Set/⚖️=2,100g

PLASTIC TRAY:W390xT180xH25	
Sockets	Accessories
 3400MZ 6-pt. Sockets 5.5, 6, 7, 8, 10, 12, 13, 14, 17, 19, 21, 22	 3725Z
 3300MZ 6-pt. Deep Sockets 8, 10, 12, 14	 3756Z
 3300CZ Spark Plug Sockets 14, 16, 20.8	 3771Z
	 3768Z-250
	 3760Z-75
	 3760Z-125
	 3760Z-250

3285ZA 15 Pieces Set/⚖️=750g

PLASTIC TRAY:W300xT90xH25	
Sockets	Accessories
 3400MZ 6-pt. Sockets 5.5, 6, 7, 8, 10, 12, 13, 14, 17, 19, 21, 22	 3725Z
	 3756Z
	 3771Z

3285ZE 9 Pieces Set/⚖️=600g

Rail 200mm/PLASTIC BAG	
Sockets	Accessories
 3400MZ 6-pt. Sockets 8, 10, 12, 13, 14, 17, 19	 3725Z
	 3756Z

RSAL200		RAIL (mm)	CLIP (pcs.)	⚖️ (g)	📦 (pce.)
1/4x12	1/4"	200	12	125	1
3/8x8	3/8"	200	8	130	1

RSAL300		RAIL (mm)	CLIP (pcs.)	⚖️ (g)	📦 (pce.)
3/8x12	3/8"	300	12	180	1
1/2x10	1/2"	300	10	190	1



RAIL

	RAIL (mm)	⚖️ (g)	📦 (pce.)
RSAL200	200	110	1
RSAL300	300	145	1
New RSAL400	400	210	1

CLIP

CLIP.P/5		⚖️ (g)	📦 (pce.)
1/4	1/4"	10	5
3/8	3/8"	13	5
1/2	1/2"	20	5

1/2"

Z-series
Z-serie
Series-Z

4400MZ (mm)	D ₁ (mm)	D ₂ (mm)	ℓ (mm)	L (mm)	(g)	(pcs.)
8	12.6	20.6	4.5	26	30	10
10	15	20.6	4.5	26	31	10
12	17.5	20.6	5.5	27	32	10
13	18.7	21.5	6.5	28	40	10
14	19.8	21.5	6.5	28	40	10
16	22.3	21.5	7.5	28	43	10
17	23.6	22.5	7.5	29	49	10
18	24.8	23.7	7.5	29	56	10
19	26	24.4	9.5	29	62	10
21	28.4	26.3	10.5	29	76	10
22	29.6	27.5	11	29	83	10
24	32	29.2	12	29	96	5
27	35.7	32.2	13.5	30	124	5
30	39.3	35.2	14.5	31	156	5
32	41.7	36.8	15.5	32	178	5

4400MZ  6-point Sockets
6-kant Steckschlüssel
Douilles 6-pans

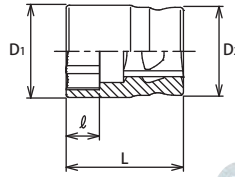

RS4400MZ/10	10 Pieces Set/Rail 300mm	(g)
10, 12, 13, 14, 17, 19, 21, 22, 24, 27		830

RS4400MZ/10   Socket Set on magnetic Rail
Steckschlüsselsatz auf Magnetschiene
Jeu de douilles sur rail à aimant



4725Z Reversible Ratchet
Knarre, verstellbar
Cliquet, réversible

36



	D (mm)	T (mm)	H (mm)	L (mm)	(g)	(pce.)
4725Z	36.5	32.8	18.2	253	590	1

* Renewal Kits → **4725RK** → P299

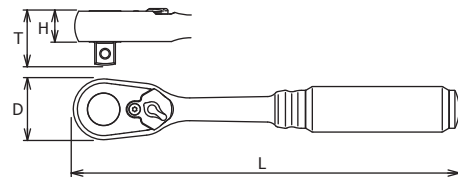

4768Z-430 Hinge Handle
Gelenkgriff
Poignée articulée



	D (mm)	L (mm)	(g)	(pce.)
4768Z-430	28	430	720	1

* Renewal Kits → **4768ZRK** → P300

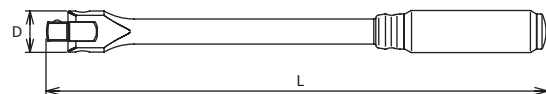

Z-SERIES
HAND
TITANIUM
ACCESSORIES
SCREWDRIVERS
IMPACT
SLEEVE-DRIVE
PROTECTOR
INDUSTRIAL
AUTOMOTIVE
MOTORCYCLE
CONSTRUCTION
SPARE PART

4760Z-125/-250

Extension Bars
Verlängerungen
Rallonges

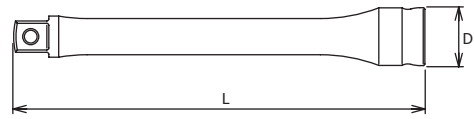

4760Z	D (mm)	L (mm)	(g)	(pcs.)
125	22.5	125	180	5
250	22.5	250	340	5

4771Z

Universal Joint
Gelenk-Einsatz
Joint articlé

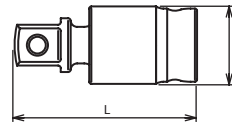

4771Z	D (mm)	L (mm)	(g)	(pcs.)
4771Z	23.7	55.8	100	10

4756Z

Quick Spinner
Rändel-Drehscheibe
Lanceur

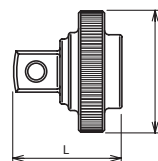

4756Z	D (mm)	L (mm)	(g)	(pcs.)
4756Z	36.3	33.5	84	10



4285Z

Set in Foam tray
Steckschlüsselsatz in Weichschaumeinlage
Set disposé dans boîte de rangement en mousse souple



4285Z 21 Pieces Set/△=4,800g

METAL CASE:W445xT190xH50

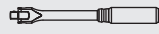
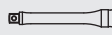
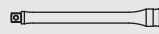
Sockets	Accessories
4400MZ 6-pt. Sockets 8, 10, 12, 13, 14, 16, 17, 18, 19, 21, 22, 24, 27, 30, 32	 4725Z  4756Z  4771Z  4768Z-430  4760Z-125  4760Z-250



4285ZE

Socket Sets
Steckschlüssel Sätze
Jeu de clés à douilles



4285ZE 11 Pieces Set/△=1,380g

Rail 300mm/PLASTIC BAG

Sockets	Accessories
4400MZ 6-pt. Sockets 10, 12, 13, 14, 17, 19, 21, 22, 24	 4725Z  4756Z