



1/4"

3/8"

1/2"

3/4"

1"

HAND







































SOCKETS
STECKSCHLÜSSEL
DOUILLES À MAIN









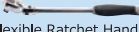
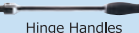
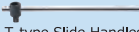

Hand Sockets

Hand Steckschlüssel

Douilles à main

Hand Sockets	Square Drive														
	1/4"(6.35mm)SQ.			3/8"(9.5mm)SQ.			1/2"(12.7mm)SQ.		3/4"(19mm)SQ.		1"(25.4mm)SQ.				
	No.	Page		No.	Page		No.	Page	No.	Page	No.	Page			
Standard Sockets	 6-point	2400M mm 48	2400A inch 48	2400W BA 49	3400M mm 68	3400A inch 68	3400W BSW 69	4401M/4400M mm 102	4400A inch 103	4400W BSW 104	6400M mm 130	6400A inch 130	8400M mm 136	8400A inch 136	
	 12-point	2405M mm 48	2405A inch 48	AS2405A inch 48	3405M mm 68	3405A inch 68	3405W BSW 69	4406M/4405M mm 102	4405A inch 103	4405W BSW 104	6405M mm 130	6405A inch 130	8405M mm 136	8405A inch 136	
	 Surface	2410M mm 49			3410M mm 69			4410M mm 104							
	 NUT GRIP®	2450MS mm 50	2450AS inch 50		3450M mm 71	3450A inch 71	3450MH mm 71	4450M mm 106							
	 NUT GRIP® (3-ball)	2455AS inch 50													
	 TORX® (E)	2425 TORX® 51			3425 TORX® 70			4425 TORX® 105	4425-N TORX® 104		6425 TORX® 130				
	 TORX®(E) (NUT GRIP®)				3425(2B) TORX® 71										
	 TORXplus® (EP)							4425-EPL TORXplus® 105							
	 TORXplus® (EPR)							4425-EPRL TORXplus® 105							
	 LH-S				3400LH LH-STIX® 70			4400LH LH-STIX® 106							
 Double Square	2415M mm 49	2415A inch 49		3415M mm 70	3415A inch 70										
Semi Deep Sockets	 6-point	2300X mm 51			3300X mm 72	3300XA inch 72									
	 12-point				3305X mm 72	3305XA inch 72									
	 NUT GRIP®	2350X mm 51			3350X mm 72										
Deep Sockets	 6-point	2300M mm 52	2300A inch 52	2300W BA 53	3300M mm 73	3300A inch 73	3300W BSW 74	4300M mm 107	4300A inch 107	6300M mm 131	6300A inch 131				
	 12-point	2305M mm 52	2305A inch 52	AS2305A inch 52	3305M mm 73	3305A inch 73	3305W BSW 74	4305M mm 107	4305A inch 107	6305M mm 131	6305A inch 131				
	 Surface	2310M mm 53			3310M mm 74			4310M mm 108							
	 NUT GRIP®	2350M mm 53			3350M mm 75										
	 TORX® (E)	2325 TORX® 53			3325 TORX® 75			4325 TORX® 108							
	 Flare Nut				3300FN mm 75										
Extra Deep Sockets	 6-point				3300M(L120) mm 76			4300M(L120) mm 109							
	 12-point				3305M(L120) mm 76										
	 NUT GRIP®				3350M(L120) mm 76	3350A(L120) inch 76									
	 TORX® (E)							4325(L140) TORX® 109							
	 TORX®(E) (NUT GRIP®)							4325(L140)-2B TORX® 109							
Extension Sockets	 12-point				3117M mm 79			4117M mm 109							
Universal Sockets	 6-point	2440M mm 54	2440A inch 54		3440M mm 77	3440A inch 77		4440M mm 110	4440A inch 110						
	 12-point	2445M mm 54	2445A inch 54	AS2445A inch 54	3445M mm 77	3445A inch 77	3445W BSW 77	4445M mm 110	4445A inch 110						
	 NUT GRIP®	2441M mm 54			3441M mm 78										
	 TORX® (E)	2440T TORX® 54			3440T TORX® 77			4440T TORX® 110							
Universal Deep Sockets	 6-point				3340M mm 78										
Bit Sockets	 PH	2000 PH 55			3000 PH 80			4000 PH 110							
	 PZ	2000(PZ) PZ 55			3000(PZ) PZ 80			4000(PZ) PZ 110							
	 Slotted	2005 Slotted 55			3005 Slotted 80			4005 Slotted 110							
	 Hexagon	2010M mm 56	2010A inch 56		3010M mm 81	3010A inch 81	3012M mm 82	4010M mm 111	4010A inch 111	4012M mm 112	6012M mm 131	8012M mm 137			
	 Hexagon (Grip Ring)				3012A inch 82	3015M mm 83		4012M mm 112	4012A inch 113						
	 Hexagon (Ball Point)	2011M mm 56			3011M mm 83										
	 XZN (Triple Square)	2020 XZN 56			3020 XZN 84			4020 XZN 114							
	TORX® (T)	2025(T) TORX® 57			3025(T) TORX® 85			4025(T) TORX® 115							
	TORX® (TH)	2025(TH) TORX® 57			3025(TH) TORX® 86										
	TORXplus® (IP)	2025(IP) TORXplus® 58			3025(IP) TORXplus® 87			4025(IP) TORXplus® 116							
	TORXplus® (IPR)	2025(IPR) TORXplus® 58			3025(IPR) TORXplus® 88										
	Ribe CV				3027 Ribe CV 88			4027 Ribe CV 116							
	Universal Bit Sockets	Hexagon	2430M mm 55			3430M mm 79									
TORX® (T)		2430T TORX® 55													

Handles/Accessories		Square Drive									
		1/4" (6.35mm)SQ.		3/8" (9.5mm)SQ.		1/2" (12.7mm)SQ.		3/4" (19mm)SQ.		1" (25.4mm)SQ.	
		No.	Page	No.	Page	No.	Page	No.	Page	No.	Page
 Ratchet Handles	Standard	2753 series	59-60	3753 series 3752 series	91-92 91	4753 series 4750 series 4752 series	120 119 118	6749 6752	132 132	8749	138
	Short	2753PS	59	3749S series	90						
	Long	2753P-160	59	3753P-250	91	4749-380 series 4753P-410	121 121	6749-1000	132	8749-1000	138
	Compact			2749-3/8 series	90	3749S-1/2 series	118				
	Others			3753SM series 3757	90 95						
 Flexible Ratchet Handles	Standard	2774 series	61	3774 series	93-94	4774 series	121-122				
	Short	2774PS 2774JS	60 60	3774PS	92						
	Long					4774P-450	121				
	Compact			2774-3/8 series	92						
	Swivel Head			3776 series	94						
	Speeder			3774P-SR	94						
 Hinge Handles	Standard	2768 series	62	3768-250 series	97	4768-380 series	122	6768	133	8768	138
	Long					4768-450 series	122	6768-600	133	8768-1000	138
	Extra Long			3768P-380	97	4768-600 series	122	6768-1000	133		
 T-type Slide Handles	Standard	2785	64	3785	98	4785	124	6785	134	8785	138
	Long									8785-700	138
 Spin Type Handles	Standard	2769N	63	3769N	97						
	Wobble-Fix	2769NWF	63	3769NWF	97						
	Others	2769H	63	3769H	97						
 L-handles						4788 4747	125 125	6788	134	8788	138
 Speed Handles	Standard	2780	64	3780	98	4780-400	124				
	Flexible					4781N-450	124				
 Extension Bars	Standard	2760	62	3760	96	4760	123	6760	133	8760	137
	Wobble-Fix	2763	62	3763	96	4763	123				
	Flexible	2762	61	3762	95						
 Universal Joints		2770 2771	64 64	3770 3771	98 98	4770 4771	124 124	6770	134	8770	137
	 Adaptors	2233A	64	3322A 3344A	98 98	4433A 4466A	125 125	6644A 6688A	134 134	8866A	137
 Ratchet Adaptors		2755	61	3755	95	4755	122	6755	133		
 Quick Spinners		2756	61	3756	95	4756	122				

Z-SERIES
HAND
TITANIUM
ACCESSORIES
SCREWDRIVERS
IMPACT
SLEEVE-DRIVE
PROTECTOR
INDUSTRIAL
AUTOMOTIVE
MOTORCYCLE
CONSTRUCTION
SPARE PART

2400M / 2400A

6-point Sockets
6-kant Steckschlüssel
Douilles 6-pans

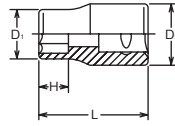

2400M 2405M (mm)	D ₁ (mm)	D ₂ (mm)	H (mm)	L (mm)	(g)	(pcs.)
3	5.5	11.2	2.6	22	7	10
3.5	6.1	11.2	3	22	7	10
4	6.7	11.2	3.5	22	8	10
4.5	7.3	11.2	4	22	8	10
5	8	11.2	5	22	8	10
5.5	8.5	11.2	5.5	22	9	10
6	9.2	11.2	5.5	22	9	10
7	10.3	11.2	6	22	9	10
8	11.2	11.7	6.9	22	11	10
9	13	12	7.3	22	12	10
10	14.3	12.9	7.7	22	15	10
11	15.5	14.3	9.3	22	18	10
12	16.8	15.5	9.3	22	23	10
13	18	16.4	9.8	22	23	10
14	19.3	17.9	11	24	30	10

2405M / 2405A

12-point Sockets
12-kant Steckschlüssel
Douilles 12-pans

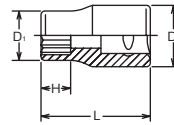

2400A 2405A (inch)	D ₁ (mm)	D ₂ (mm)	H (mm)	L (mm)	(g)	(pcs.)
1/8	5.7	11.2	2.7	22	7	10
5/32	6.7	11.2	3.5	22	8	10
3/16	7.8	11.2	5	22	8	10
7/32	8.5	11.2	5.5	22	9	10
1/4	9.6	11.2	5.8	22	9	10
9/32	10.3	11.2	6	22	9	10
5/16	11.2	11.7	6.9	22	11	10
11/32	12.5	11.7	7.3	22	12	10
3/8	13.7	12.5	7.7	22	15	10
7/16	15.5	14.3	9.3	22	18	10
1/2	18	16.4	9.8	22	23	10
9/16	19.3	17.9	11	24	30	10

RS2400M/12 RS2405M/12

Socket Set on Rail
Steckschlüsselsatz auf Schiene
Jeu de douilles sur rail



RS2400M/12	12 Pieces Set/Rail 200mm	(g)
4, 5, 5.5, 6, 7, 8, 9, 10, 11, 12, 13, 14		200

RS2405M/12	12 Pieces Set/Rail 200mm	(g)
4, 5, 5.5, 6, 7, 8, 9, 10, 11, 12, 13, 14		200

RS2400A/9 RS2405A/9

Socket Set on Rail
Steckschlüsselsatz auf Schiene
Jeu de douilles sur rail



RS2400A/9	9 Pieces Set/Rail 150mm	(g)
3/16, 7/32, 1/4, 9/32, 5/16, 11/32, 3/8, 7/16, 1/2		162

RS2405A/9	9 Pieces Set/Rail 150mm	(g)
3/16, 7/32, 1/4, 9/32, 5/16, 11/32, 3/8, 7/16, 1/2		162

AS2405A

12-point Sockets, AS954
12-kant Steckschlüssel, AS954
Douilles 12-pans, AS954

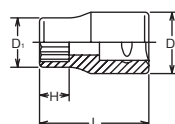

AS2405A (inch)	D ₁ (mm)	D ₂ (mm)	H (mm)	L (mm)	(g)	(pcs.)
3/16	7.7	10.9	5.1	22	8	10
7/32	8.5	10.9	5.5	22	8	10
1/4	9.4	10.9	5.9	22	8	10
9/32	10.2	10.9	6.1	22	8	10
5/16	11.3	11.7	7.3	22	10	10
11/32	12.5	12	7.5	22	10	10
3/8	13.7	12.9	8.2	22	13	10
7/16	15.6	14.3	9.4	22	17	10
1/2	17.2	16.4	10.3	22	20	10
9/16	18.8	17.9	11	24	27	10

Aerospace Standard SAE AS954

RSAS2405A/10

Socket Set on Rail
Steckschlüsselsatz auf Schiene
Jeu de douilles sur rail



RSAS2405A/10	10 Pieces Set/Rail 150mm	(g)
3/16, 7/32, 1/4, 9/32, 5/16, 11/32, 3/8, 7/16, 1/2, 9/16		160

1/4"

Hand Sockets
Hand Steckschlüssel
Douilles à main

2410M (mm)	D ₁ (mm)	D ₂ (mm)	H (mm)	L (mm)	(g)	(pcs.)
4	6.7	11.2	3.5	22	8	10
4.5	7.3	11.2	4	22	8	10
5	8	11.2	5	22	8	10
5.5	8.5	11.2	5.5	22	9	10
6	9.2	11.2	5.5	22	9	10
7	10.3	11.2	6	22	9	10
8	11.2	11.7	6.9	22	11	10
9	13	12	7.3	22	12	10
10	14.3	12.9	7.7	22	15	10
11	15.5	14.3	9.3	22	18	10
12	16.8	15.5	9.3	22	23	10
13	18	16.4	9.8	22	23	10
14	19.3	17.9	11	24	30	10



2410M Surface Drive Sockets
Surface Drive Steckschlüssel
Douilles, Surface Drive

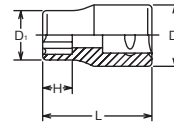

RS2410M/12	12 Pieces Set/Rail 200mm	(g)
4, 5, 5.5, 6, 7, 8, 9, 10, 11, 12, 13, 14		222

RS2410M/12 Socket Set on Rail
Steckschlüsselsatz auf Schiene
Jeu de douilles sur rail



2400W (BA)	D ₁ (mm)	D ₂ (mm)	H (mm)	L (mm)	(g)	(pcs.)
8	6.1	11.2	3	22	7	10
7	7.3	11.2	4	22	8	10
6	8	11.2	5	22	8	10
5	8.5	11.2	5.5	22	9	10
4	9.6	11.2	5.8	22	9	10
3	10.3	11.2	6	22	9	10
2	11.2	11.7	6.9	22	11	10
1	13	12	7.3	22	12	10
0	14.9	13.6	8	22	16	10

2400W-BA 6-point Sockets
6-kant Steckschlüssel
Douilles 6-pans

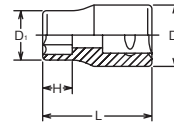

RS2400W/9-BA	9 Pieces Set/Rail 150mm	(g)
8, 7, 6, 5, 4, 3, 2, 1, 0		120

RS2400W/9-BA Socket Set on Rail
Steckschlüsselsatz auf Schiene
Jeu de douilles sur rail



S	BA									
	8BA	7BA	6BA	5BA	4BA	3BA	2BA	1BA	0BA	
(ref. mm)	3.86	4.37	4.90	5.59	6.30	7.16	8.23	9.27	10.49	
(ref. inch)	0.152	0.172	0.193	0.220	0.248	0.282	0.324	0.365	0.413	

2415M (mm)	D ₁ (mm)	D ₂ (mm)	H (mm)	L (mm)	(g)	(pcs.)
5.5	10.3	11.2	5.4	22	10	10
6	11	11.7	5.4	22	13	10
7	12.5	11.7	6.1	22	13	10
8	14.3	12.9	6.8	22	17	10
10	17.4	16	8.2	22	27	10

2415M / 2415A Double 4-point Sockets
Doppelvierkant Steckschlüssel
Douilles mâles 4-pans doubles

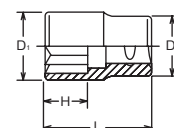

2415A (inch)	D ₁ (mm)	D ₂ (mm)	H (mm)	L (mm)	(g)	(pcs.)
1/4	11	11.7	5.4	22	14	10
5/16	14.3	12.9	6.8	22	17	10
11/32	15.9	14.3	7.5	22	21	10
3/8	17.4	16	8.2	22	26	10

TORX is a registered trademark of CAMCAR Innovations.
TORX ist ein registriertes Markenzeichen der Firma CAMCAR Innovations.
TORX est une marque déposée de CAMCAR Innovations.

Z-SERIES
HAND
TITANIUM
ACCESSORIES
SCREWDRIVERS
IMPACT
SLEEVE-DRIVE
PROTECTOR
INDUSTRIAL
AUTOMOTIVE
MOTORCYCLE
CONSTRUCTION
SPARE PART

2450MS / 2450AS

 Nut Grip Sockets **Nut Grip®**
Steckschlüssel mit 2-facher Kugelhalterung
Douilles à billes de retenue

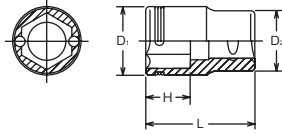

	2450MS (mm)	D ₁ (mm)	D ₂ (mm)	H (mm)	L (mm)	(g)	(pcs.)
New	5	9.2	11.2	3.5	17	6	10
New	5.5	9.8	11.2	3.5	17	7	10
New	6	10.2	11.2	3.5	17	8	10
	7	11.5	11.2	4	18	8	10
	8	12.3	11.7	5	18	9	10
New	9	13.3	12	5.5	19	12	10
	10	14.3	12.9	6	19	13	10
New	11	15.8	14.3	6.5	20	15	10
	12	16.8	16	7	20	22	10
	13	18	17	8	21	22	10
	14	20	18	8.5	22	31	10

	2450AS (inch)	D ₁ (mm)	D ₂ (mm)	H (mm)	L (mm)	(g)	(pcs.)
New	1/4	10.7	11.2	3.5	17	8	10
New	5/16	12.3	11.7	5	18	9	10
New	3/8	14.3	12.9	6	19	14	10
New	7/16	16	14.3	6.5	20	17	10
New	1/2	18	16.4	8	21	23	10
New	9/16	20	18	8.5	22	31	10

RS2450MS/11

 Socket Set on Rail
Steckschlüsselsatz auf Schiene
Jeu de douilles sur rail



	RS2450MS/11	11 Pieces Set/Rail 200mm	(g)
New		5, 5.5, 6, 7, 8, 9, 10, 11, 12, 13, 14	194

RS2450AS/6

 Socket Set on Rail
Steckschlüsselsatz auf Schiene
Jeu de douilles sur rail



	RS2450AS/6	6 Pieces Set/Rail 150mm	(g)
New		1/4, 5/16, 3/8, 7/16, 1/2, 9/16	120

2455AS

 12-point Nut Grip® Sockets with 3 Ball retaining
12-kant Steckschlüsseleinsätze mit 3fach Kugelsicherung
Douilles pour écrous à 12 points avec 3 retenues de billes

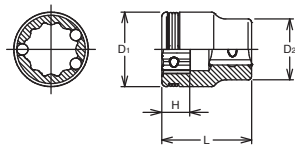

	2455AS (inch)	D ₁ (mm)	D ₂ (mm)	H (mm)	L (mm)	(g)	(pcs.)
New	7/32	10.2	11.2	3.5	17	8	10
New	1/4	11.8	11.2	3.5	17	9	10
New	9/32	12.5	11.2	4	17	10	10
New	5/16	13.5	11.7	5	18	12	10
New	11/32	14.1	12	5.5	19	14	10
New	3/8	15.4	12.9	6	19	16	10
New	7/16	17	15	6.5	20	21	10
New	1/2	18.9	17	8	21	26	10
New	9/16	20.7	18.7	8.5	22.5	34	10

RS2455AS/6

 Socket Set on Rail
Steckschlüsselsatz auf Schiene
Jeu de douilles sur rail



	RS2455AS/6	6 Pieces Set/Rail 150mm	(g)
New		1/4, 5/16, 3/8, 7/16, 1/2, 9/16	138

1/4" Hand Sockets Hand Steckschlüssel Douilles à main

2425 (E)	D ₁ (mm)	D ₂ (mm)	H (mm)	L (mm)	(g)	(pcs.)
E 4	5.4	11.2	4.6	22	7	10
E 5	6.7	11.2	5.2	22	8	10
E 6	7.7	11.2	5.4	22	8	10
E 7	8.3	11.2	6.6	22	9	10
E 8	9.6	11.2	7	22	9	10
E10	11.3	12	8.2	22	10	10
E11	12.9	12	8.7	22	13	10
E12	14.3	12.9	9.3	23	17	10

2425 TORX® Sockets
TORX® Steckschlüssel
Douilles TORX®

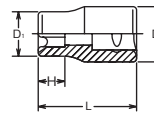

RS2425/6	6 Pieces Set/Rail 150mm	(g)
E4, E5, E6, E7, E8, E10		85

RS2425/6 Socket Set on Rail
Steckschlüsselsatz auf Schiene
Jeu de douilles sur rail



TORX®
(E)

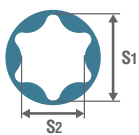

E	E4	E5	E6	E7	E8	E10	E11	E12	E14	E16	E18	E20	E22	E24	E26	E28	E30	E32
S ₁ (ref. mm)	3.7	4.6	5.6	6.1	7.4	9.3	9.9	11.0	12.8	14.6	16.5	18.3	20.1	22.0	23.7	25.5	27.3	29.0
S ₂ (ref. mm)	2.7	3.3	4.0	4.3	5.3	6.8	7.1	7.9	9.2	10.5	11.9	13.2	14.8	15.7	17.5	18.3	20.0	21.3

2300X (mm)	D ₁ (mm)	D ₂ (mm)	H ₁ (mm)	H ₂ (mm)	L (mm)	(g)	(pcs.)
4	6.7	11.2	4	22	32	10	10
5	8	11.2	5.5	22	32	11	10
5.5	8.5	11.2	6	22	32	12	10
6	9.2	11.2	7	22	32	12	10
7	10.5	11.2	8	22	32	13	10
8	11.8	11.2	9	22	32	16	10
9	13	12	10	22	32	18	10
10	14.3	12.9	11	21	32	23	10
11	15.5	14.3	12	21	32	27	10
12	16.8	15.5	13	21	32	29	10
13	18	16.4	14	21	32	32	10
14	19.3	17.9	16	20	32	37	10

2300X 6-point Sockets, Semi-Deep
6-kant Steckschlüssel, mittel-lang
Douilles, semi-profondes 6-pans

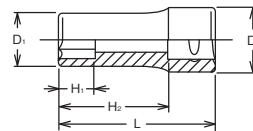

RS2300X/12	12 Pieces Set/Rail 200mm	(g)
4, 5, 5.5, 6, 7, 8, 9, 10, 11, 12, 13, 14		270

RS2300X/12 Socket Set on Rail
Steckschlüsselsatz auf Schiene
Jeu de douilles sur rail



2350X (mm)	D ₁ (mm)	D ₂ (mm)	H ₁ (mm)	H ₂ (mm)	L (mm)	(g)	(pcs.)
8	12.3	11.7	5	21.5	32	17	10
10	14.3	12.9	6	21.5	32	22	10
12	16.8	16	7	21.5	32	34	10
13	18	17	8	21.5	32	40	10
14	20	18	8.5	21.5	32	43	10

2350X Nut Grip Socket, Semi-Deep Nut Grip®
Steckschlüssel mit 2-facher Kugelhalterung, mittel-lang
Douilles à billes de retenue, semi-profondes

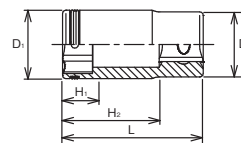

RS2350X/4	4 Pieces Set/Rail 150mm	(g)
8, 10, 12, 14		140

RS2350X/4 Socket Set on Rail
Steckschlüsselsatz auf Schiene
Jeu de douilles sur rail



NUT GRIP®

2300M / 2300A

6-point Deep Sockets
6-kant-Steckschlüssel, lang
Douilles longues 6-pans

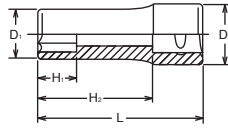
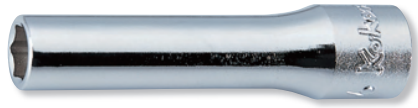

2300M / 2300A (mm)	D ₁ (mm)	D ₂ (mm)	H ₁ (mm)	H ₂ (mm)	L (mm)	(g)	(pcs.)
3	5.5	11.2	3	40	50	15	10
4	6.7	11.2	4	40	50	15	10
4.5	7.3	11.2	4.5	40	50	15	10
5	8	11.2	5.5	40	50	17	10
5.5	8.5	11.2	6	40	50	17	10
6	9.2	11.2	7	40	50	20	10
7	10.5	11.2	8	40	50	25	10
8	11.8	11.2	9	40	50	25	10
9	13	12	10	40	50	30	10
10	14.3	12.9	11	39	50	34	10
11	15.5	14.3	12	39	50	43	10
12	16.8	15.5	13	39	50	50	10
13	18	16.4	14	39	50	52	10
14	19.3	17.9	16	38	50	57	10

2305M / 2305A

12-point Deep Sockets
12-kant-Steckschlüssel, lang
Douilles longues, 12-pans

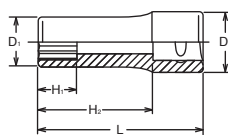

2300A / 2305A (inch)	D ₁ (mm)	D ₂ (mm)	H ₁ (mm)	H ₂ (mm)	L (mm)	(g)	(pcs.)
1/8	5.7	11.2	3.5	40	50	15	10
5/32	6.7	11.2	4	40	50	15	10
3/16	7.8	11.2	5.5	40	50	17	10
7/32	8.5	11.2	6	40	50	17	10
1/4	9.8	11.2	7	40	50	25	10
9/32	10.5	11.2	8	40	50	25	10
5/16	11.8	11.2	9	40	50	25	10
11/32	12.5	11.7	10	40	50	30	10
3/8	13.7	12.5	11	40	50	34	10
7/16	15.5	14.3	12	39	50	43	10
1/2	18	16.4	14	39	50	52	10
9/16	19.3	17.9	16	38	50	57	10

RS2300M/12

Socket Set on Rail
Steckschlüsselsatz auf Schiene
Jeu de douilles sur rail



RS2300M/12	12 Pieces Set/Rail 200mm	(g)
4, 5, 5.5, 6, 7, 8, 9, 10, 11, 12, 13, 14		400

RS2305M/12	12 Pieces Set/Rail 200mm	(g)
4, 5, 5.5, 6, 7, 8, 9, 10, 11, 12, 13, 14		400

RS2300A/9

Socket Set on Rail
Steckschlüsselsatz auf Schiene
Jeu de douilles sur rail



RS2300A/9	9 Pieces Set/Rail 150mm	(g)
3/16, 7/32, 1/4, 9/32, 5/16, 11/32, 3/8, 7/16, 1/2		296

RS2305A/9	9 Pieces Set/Rail 150mm	(g)
3/16, 7/32, 1/4, 9/32, 5/16, 11/32, 3/8, 7/16, 1/2		296

AS2305A

12-point Deep Sockets, AS954
12-kant-Steckschlüssel, lang, AS954
Douilles longues 12-pans, AS954

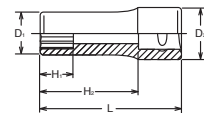
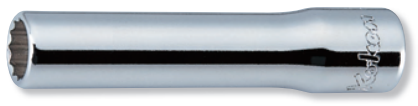

AS2305A (inch)	D ₁ (mm)	D ₂ (mm)	H ₁ (mm)	H ₂ (mm)	L (mm)	(g)	(pcs.)
3/16	7.7	10.9	6	40	50	17	10
7/32	8.5	10.9	6.5	40	50	17	10
1/4	9.4	10.9	7	40	50	19	10
9/32	10.2	10.9	8	40	50	18	10
5/16	11.3	11.7	9	40	50	23	10
11/32	12.5	12	10	40	50	24	10
3/8	13.7	12.8	11	39	50	31	10
7/16	15.6	14.2	12	39	50	38	10
1/2	17.2	16.2	14	39	50	42	10
9/16	18.8	17.1	16	38	50	47	10

Aerospace Standard SAE AS954

RSAS2305A/10	10 Pieces set/Rail 150mm	(g)
3/16, 7/32, 1/4, 9/32, 5/16, 11/32, 3/8, 7/16, 1/2, 9/16		307

RSAS2305A/10

Socket Set on Rail
Steckschlüsselsatz auf Schiene
Jeu de douilles sur rail



1/4" Hand Sockets Hand Steckschlüssel Douilles à main

2310M (mm)	D ₁ (mm)	D ₂ (mm)	H ₁ (mm)	H ₂ (mm)	L (mm)	(g)	(pcs.)
3	5.5	11.2	3	40	50	15	10
4	6.7	11.2	4	40	50	15	10
4.5	7.3	11.2	4.5	40	50	15	10
5	8	11.2	5.5	40	50	17	10
5.5	8.5	11.2	6	40	50	17	10
6	9.2	11.2	7	40	50	20	10
7	10.5	11.2	8	40	50	25	10
8	11.8	11.2	9	40	50	25	10
9	13	12	10	40	50	30	10
10	14.3	12.9	11	39	50	34	10
11	15.5	14.3	12	39	50	43	10
12	16.8	15.5	13	39	50	50	10
13	18	16.4	14	39	50	52	10
14	19.3	17.9	16	38	50	57	10



2310M Surface Drive Deep Sockets
Surface Drive Steckschlüssel, lang
Douilles longues, Surface Drive

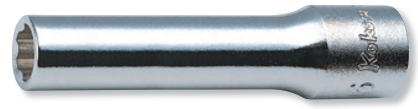
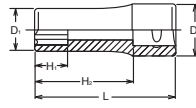

RS2310M/12	12 Pieces set/Rail 200mm	(g)
4, 5, 5.5, 6, 7, 8, 9, 10, 11, 12, 13, 14		400

RS2310M/12 Socket Set on Rail
Steckschlüsselsatz auf Schiene
Jeu de douilles sur rail



2300W (BA)	D ₁ (mm)	D ₂ (mm)	H ₁ (mm)	H ₂ (mm)	L (mm)	(g)	(pcs.)
4	9.8	11.2	7	40	50	22	10
3	10.5	11.2	8	40	50	25	10
2	11.8	11.2	9	40	50	25	10
1	13	12	10	40	50	30	10
0	14.9	13.6	12	39	50	38	10

2300W-BA 6-point Deep Sockets
6-kant-Steckschlüssel, lang
Douilles longues 6-pans

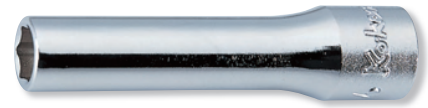
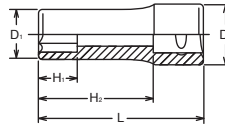

S	BA	8BA	7BA	6BA	5BA	4BA	3BA	2BA	1BA	0BA
	(ref. mm)	3.86	4.37	4.90	5.59	6.30	7.16	8.23	9.27	10.49
(ref. inch)	0.152	0.172	0.193	0.220	0.248	0.282	0.324	0.365	0.413	

2325 (E)	D ₁ (mm)	D ₂ (mm)	H ₁ (mm)	H ₂ (mm)	L (mm)	(g)	(pcs.)
E 4	5.4	12	4.6	40	50	17	10
E 5	6.8	12	5.2	40	50	20	10
E 6	8	12	5.4	40	50	20	10
E 7	8.3	12	6.6	40	50	22	10
E 8	9.8	12	7	40	50	25	10
E10	11.6	12	8.2	40	50	29	10

2325 TORX® Deep Sockets
TORX® Steckschlüssel, lang
Douilles longues TORX®

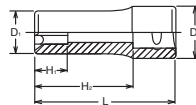

S ₁	S ₂	E	E4	E5	E6	E7	E8	E10	E11	E12	E14	E16	E18	E20	E22	E24	E26	E28	E30	E32
		(ref. mm)	3.7	4.6	5.6	6.1	7.4	9.3	9.9	11.0	12.8	14.6	16.5	18.3	20.1	22.0	23.7	25.5	27.3	29.0
		(ref. mm)	2.7	3.3	4.0	4.3	5.3	6.8	7.1	7.9	9.2	10.5	11.9	13.2	14.8	15.7	17.5	18.3	20.0	21.3

2350M (mm)	D ₁ (mm)	D ₂ (mm)	H ₁ (mm)	H ₂ (mm)	L (mm)	(g)	(pcs.)
8	12.3	11.7	5	39.5	50	30	10
10	14.3	12.9	6	39.5	50	35	10
12	16.8	16	7	39.5	50	55	10
13	18	17	8	39.5	50	65	10
14	20	18	8.5	39.5	50	70	10



2350M Nut Grip Deep Sockets **Nut Grip®**
Steckschlüssel mit 2-facher Kugelhalterung, lang
Douilles longues à billes de retenue

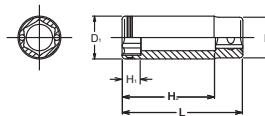

RS2350M/4	4 Pieces Set/Rail 150mm	(g)
8, 10, 12, 14		220

RS2350M/4 Socket Set on Rail
Steckschlüsselsatz auf Schiene
Jeu de douilles sur rail

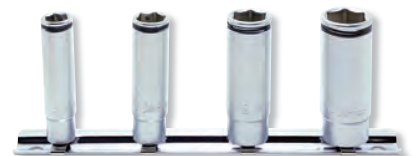

TORX is a registered trademark of CAMCAR Innovations.
TORX ist ein registriertes Markenzeichen der Firma CAMCAR Innovations.
TORX est une marque déposée de CAMCAR Innovations.

2440M / 2440A

6-point Universal Sockets
6-kant Gelenk-Einsätze
Douilles articulées, 6-pans

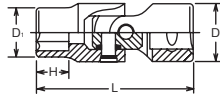

2445M / 2445A

12-point Universal Sockets
12-kant Gelenk-Einsätze
Douilles articulées, 12-pans

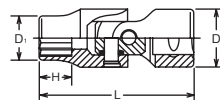
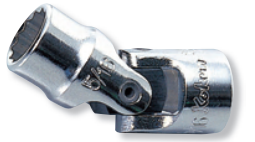

RS2445A/9

Socket Set on Rail
Steckschlüsselsatz auf Schiene
Jeu de douilles sur rail



AS2445A

12-point Universal Sockets
12-kant Gelenk-Einsätze
Douilles articulées, 12-pans

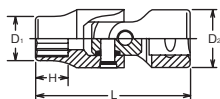

2440T

TORX® Universal Sockets
TORX® Gelenk-Einsätze
Douilles articulées TORX®

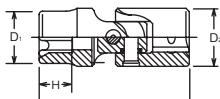
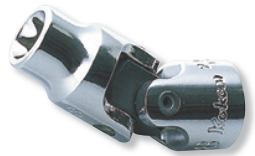

2441M

Nut Grip Universal Sockets **Nut Grip®**
Gelenk-Einsätze mit zweifacher Kugelhalterung
Douilles articulées à billes de retenue

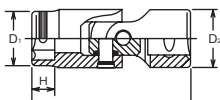
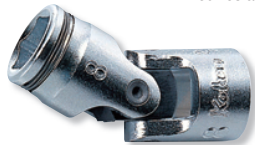

RS2441M/11

Socket Set on Rail
Steckschlüsselsatz auf Schiene
Jeu de douilles sur rail



2440M / 2445M (mm)	D ₁ (mm)	D ₂ (mm)	H (mm)	L (mm)	(g)	(pcs.)
4	6.7	13	4.8	31.5	17	10
5	8	13	5.3	32	17	10
6	9.2	13	6.1	33	18	10
7	10.5	13	6.5	33	19	10
8	11.7	13	7	34	19	10
9	13	13	7	34	20	10
10	14.2	13	8.3	35	20	10
11	15.5	13	9.5	36	21	10
12	16.7	13	10	37	21	10
13	18	13	10.5	37	26	10
14	19.2	13	10.5	37	28	10

2440A (inch)	D ₁ (mm)	D ₂ (mm)	H (mm)	L (mm)	(g)	(pcs.)
1/4	9.8	13	6.5	33	18	10
5/16	11.7	13	7	34	19	10
3/8	13.7	13	8.3	35	20	10
7/16	15.5	13	9.5	36	21	10
1/2	18	13	10.5	37	26	10
9/16	19.2	13	10.5	37	28	10

2445A (inch)	D ₁ (mm)	D ₂ (mm)	H (mm)	L (mm)	(g)	(pcs.)
3/16	8	13	5.3	32	18	10
1/4	9.8	13	6.5	33	18	10
9/32	10.5	13	6.5	33	19	10
5/16	11.7	13	7	34	19	10
11/32	13	13	7	34	20	10
3/8	13.7	13	8.3	35	20	10
7/16	15.5	13	9.5	36	21	10
1/2	18	13	10.5	37	26	10
9/16	19.2	13	10.5	37	28	10

RS2445A/9	9 Pieces set/Rail 150mm	(g)
3/16, 1/4, 9/32, 5/16, 11/32, 3/8, 7/16, 1/2, 9/16		220

AS2445A (inch)	D ₁ (mm)	D ₂ (mm)	H (mm)	L (mm)	(g)	(pcs.)
1/4	9.6	12.9	5.7	31.8	18	10
5/16	11.7	12.9	7	34.6	21	10
3/8	13.5	12.9	8.3	35.1	21	10
7/16	15.5	12.9	9.5	39.1	25	10
1/2	17.2	12.9	10.5	40.1	27	10

2440T (E)	D ₁ (mm)	D ₂ (mm)	H (mm)	L (mm)	(g)	(pcs.)
E 6	8	13	5.4	31.9	20	10
E 8	9.8	13	7	33.1	20	10
E10	11.7	13	8.2	33.6	21	10
E12	14.2	13	9.3	35.1	24	10

2441M (mm)	D ₁ (mm)	D ₂ (mm)	H (mm)	L (mm)	(g)	(pcs.)
5	9.2	13	3.5	31.5	20	10
5.5	9.8	13	3.5	31.5	20	10
6	10.2	13	3.5	31.5	19	10
7	11.3	13	4	31.5	20	10
8	12.3	13	5	32	20	10
10	14.5	13	6	32.5	21	10
11	15.5	13	6.5	33.5	21	10
12	16.8	13	7	34	24	10
13	18	13	8	35	25	10
14	20	13	8.5	35.5	30	10
15	21	13	9	36	32	10

RS2441M/11	11 Pieces Set/Rail 200mm	(g)
5, 5.5, 6, 7, 8, 10, 11, 12, 13, 14, 15		280

1/4" Hand Sockets Hand Steckschlüssel Douilles à main

2430M (mm)	D (mm)	H (mm)	L (mm)	(g)	(pcs.)
3	13	5.5	40	18	10
4	13	5.5	40	18	10
5	13	6.5	40	20	10
6	13	7.5	40	21	10

2430M Universal Hex Sockets Gelenk-Einsätze für Schrauben mit Innensechskant Douilles articulées, 6-pans mâles

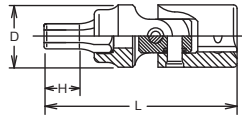

2430T (T)	D (mm)	L (mm)	(g)	(pcs.)
T 8	13	42	22	10
T 9	13	42	22	10
T10	13	42	22	10
T15	13	42	22	10
T20	13	42	22	10
T25	13	42	22	10
T27	13	42	22	10
T30	13	42	22	10

2430T TORX® Universal Sockets TORX® Gelenk-Einsätze Douilles articulées TORX®

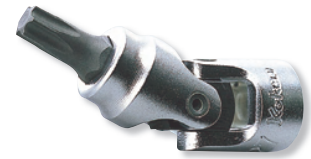
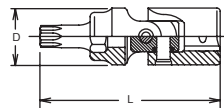

2000-28 (PH)	D (mm)	H (mm)	L (mm)	(g)	(pcs.)
1	11.9	12	28	10	10
2	11.9	12	28	11	10
3	11.9	12	28	12	10
4	13.1	11	28	14	10

2000-28 (PH) PH Bit Sockets Steckschlüssel für Kreuzschlitzschrauben, PH Douilles tournevis pour vis à empreinte PH

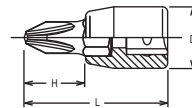

2000-28 (PZ)	D (mm)	H (mm)	L (mm)	(g)	(pcs.)
PZ1	11.9	12	28	10	10
PZ2	11.9	12	28	11	10
PZ3	11.9	12	28	12	10

2000-28 (PZ) PZ Bit Sockets Steckschlüssel für Kreuzschlitzschrauben, PZ Douilles tournevis pour vis à empreinte PZ

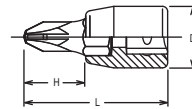

2005-25	TxW (mm)	D (mm)	H (mm)	L (mm)	(g)	(pcs.)
3	0.5x 3	11.9	9	25	9	10
4	0.8x 4	11.9	9	25	10	10
5	1.0x 5.5	11.9	9	25	10	10
6	1.2x 6.5	13.1	9	25	11	10
8	1.2x 8	13.1	9	25	12	10
9	1.6x 8	13.1	9	25	12	10
10	1.6x10	14.3	9	25	13	10

2005-25 Bit Sockets for Slotted Head Steckschlüssel für Schlitzschrauben Douilles tournevis pour vis à fente

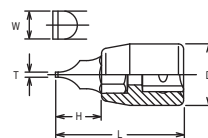

Hand Sockets
Hand Steckschlüssel
Douilles à main

1/4"

2010M-25 / -100
2010A-25 / -100

Inhex Bit Sockets
Steckschlüssel für Innensechskant-Schrauben
Douilles tournevis pour vis 6-pans creux



2010A-25 (inch)	D (mm)	H (mm)	L (mm)	(g)	(pcs.)
1/8	11.9	9	25	9	10
5/32	11.9	9	25	9	10
3/16	11.9	9	25	10	10
7/32	11.9	9	25	11	10
1/4	11.9	9	25	12	10
9/32	13.1	8	25	12	10
5/16	13.1	8	25	14	10
3/8	14.3	8	25	17	10
7/16	18.1	8	25	35	10

2010A-100 (inch)	D (mm)	H (mm)	L (mm)	(g)	(pcs.)
New 1/8	11.9	84	100	29	10
New 5/32	11.9	84	100	30	10
New 3/16	13.1	83	100	45	10
New 7/32	13.1	83	100	46	10
New 1/4	13.1	83	100	46	10
New 9/32	13.1	83	100	47	10
New 5/16	13.1	83	100	49	10
New 3/8	14.3	83	100	75	10

2010M-25 (mm)	D (mm)	H (mm)	L (mm)	(g)	(pcs.)
1.5	11.9	9	25	9	10
2	11.9	9	25	9	10
2.5	11.9	9	25	9	10
3	11.9	9	25	9	10
4	11.9	9	25	9	10
5	11.9	9	25	10	10
6	11.9	9	25	12	10
7	13.1	8	25	12	10
8	13.1	8	25	14	10
10	14.3	8	25	17	10
12	16.4	8	25	36	10

2010M-100 (mm)	D (mm)	H (mm)	L (mm)	(g)	(pcs.)
2	11.9	84	100	30	10
2.5	11.9	84	100	30	10
3	11.9	84	100	30	10
4	11.9	84	100	30	10
5	13.1	83	100	30	10
6	13.1	83	100	35	10
7	13.1	83	100	35	10
8	13.1	83	100	38	10
10	14.3	83	100	45	10
12	16.4	83	100	107	10

RS2010M/7-L25
RS2010A/8-L25

Socket Set on Rail
Steckschlüsselsatz auf Schiene
Jeu de douilles sur rail



RS2010M/7-L25	7 Pieces set/Rail 150mm	(g)
3, 4, 5, 6, 7, 8, 10		115
RS2010A/8-L25	8 Pieces set/Rail 150mm	(g)
1/8, 5/32, 3/16, 7/32, 1/4, 9/32, 5/16, 3/8		130

2011M-50

Ballpoint Inhex Sockets
Steckschlüssel mit Kugelkopf, für Innensechskant-Schrauben
Douilles tournevis avec tête sphérique pour vis 6-pans creux



2011M-50 (mm)	D (mm)	H (mm)	L (mm)	(g)	(pcs.)
3	11.9	34	50	16	10
4	11.9	34	50	17	10
5	11.9	34	50	18	10
6	11.9	34	50	18	10

Ball point bit sockets have less strength due to the special design. Make sure to use them correctly.

Kugelkopf-Biteinsätze haben aufgrund der speziellen Form eine geringere Festigkeit. Achten Sie darauf, sie richtig zu verwenden.

Les douilles pour embouts à tête sphérique sont moins résistantes en raison de leur conception spéciale. Veuillez les utiliser correctement.

2020-28 / -50

XZN Bit Sockets
Steckschlüssel für XZN Schrauben
Douilles tournevis pour empreinte XZN



2020-28 (XZN)	D (mm)	H (mm)	L (mm)	(g)	(pcs.)
M4	11.9	12	28	12	10
M5	11.9	12	28	12	10
M6	11.9	12	28	13	10
M8	13.1	11	28	14	10

2020-50 (XZN)	D (mm)	H (mm)	L (mm)	(g)	(pcs.)
M4	11.9	34	50	20	10
M5	11.9	34	50	20	10
M6	11.9	34	50	22	10
M8	13.1	33	50	24	10

XZN

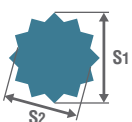

XZN		M4	M5	M6	M8	M10	M12	M14	M16	M18
S ₁	(ref. mm)	3.6	4.8	6.1	7.3	9.7	11.5	13.3	15.7	16.9
S ₂	(ref. mm)	3.1	4.1	5.1	6.1	8.1	9.7	11.2	13.2	14.2

1/4" Hand Sockets Hand Steckschlüssel Douilles à main

2025-28 (T)	D (mm)	H (mm)	L (mm)	(g)	(pcs.)
T 8	11.9	12	28	10	10
T 9	11.9	12	28	10	10
T10	11.9	12	28	10	10
T15	11.9	12	28	10	10
T20	11.9	12	28	11	10
T25	11.9	12	28	11	10
T27	11.9	12	28	12	10
T30	11.9	12	28	12	10
T40	11.9	12	28	13	10

2025-80 (T)	D (mm)	H (mm)	L (mm)	(g)	(pcs.)
T10	11.9	64	80	40	10
T15	11.9	64	80	40	10
T20	11.9	64	80	42	10
T25	11.9	64	80	42	10
T27	11.9	64	80	45	10
T30	11.9	64	80	45	10
T40	11.9	64	80	50	10

RS2025/7-L28	7 Pieces set/Rail 150mm	(g)
T10, T15, T20, T25, T27, T30, T40		119

2025-28 / -80 (T)

TORX® Bit Sockets
TORX® Bit-Steckschlüssel
Douilles tournevis, TORX®

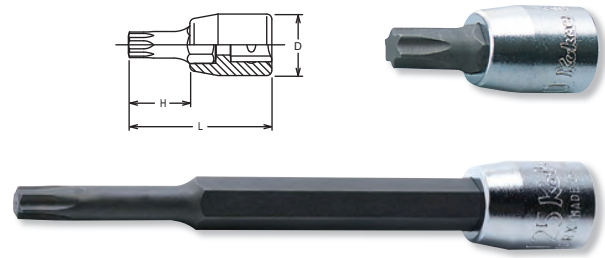

RS2025/7-L28

Socket Set on Rail
Steckschlüsselsatz auf Schiene
Jeu de douilles sur rail



TORX®
(T)

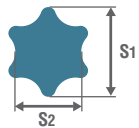

T	T8	T9	T10	T15	T20	T25	T27	T30	T40	T45	T50	T55	T60	T70	T80	T90	T100
S ₁ (ref. mm)	2.3	2.5	2.7	3.3	3.9	4.5	5.0	5.6	6.7	7.9	8.9	11.3	13.3	15.6	17.6	20.0	22.2
S ₂ (ref. mm)	1.7	1.8	2.0	2.3	2.8	3.2	3.6	4.0	4.8	5.6	6.2	8.0	9.5	11.1	12.7	14.2	15.8

2025-28 (TH)	D (mm)	H (mm)	L (mm)	(g)	(pcs.)
T10H	11.9	12	28	10	10
T15H	11.9	12	28	10	10
T20H	11.9	12	28	11	10
T25H	11.9	12	28	11	10
T27H	11.9	12	28	12	10
T30H	11.9	12	28	12	10
T40H	11.9	12	28	13	10

RS2025/7-HOLE	7 Pieces set/Rail 150mm	(g)
T10H, T15H, T20H, T25H, T27H, T30H, T40H		119



2025-28 (TH)

Tamper-Resistant TORX® Bit Sockets
Tamper-Resistant TORX® Bit-Steckschlüssel
Douilles tournevis, Tamper-Resistant TORX®

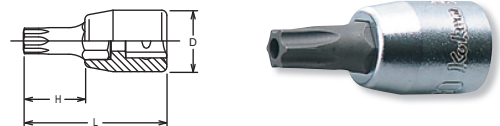

RS2025/7-HOLE

Socket Set on Rail
Steckschlüsselsatz auf Schiene
Jeu de douilles sur rail



⚠ Tamper Resistant TORX® Bit Sockets have less strength due to special design. Make sure to use it correctly.

Die manipulationssicheren TORX®-Bit-Einsätze haben aufgrund ihres speziellen Designs eine geringere Festigkeit. Achten Sie darauf, sie richtig zu verwenden.

Les douilles à embouts TORX® à l'abri des manipulations ont une résistance moindre en raison de leur conception spéciale. Veuillez les utiliser correctement.

2025-28 (IP)



TORXPLUS® Bit Sockets
TORXPLUS® Bit-Steckschlüssel
Douilles tournevis, TORXPLUS®

TORXplus

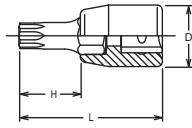

2025-28 (IP)	D (mm)	H (mm)	L (mm)	(g)	(pcs.)
8IP	11.9	12	28	10	10
9IP	11.9	12	28	10	10
10IP	11.9	12	28	10	10
15IP	11.9	12	28	10	10
20IP	11.9	12	28	11	10
25IP	11.9	12	28	11	10
27IP	11.9	12	28	12	10
30IP	11.9	12	28	12	10
40IP	11.9	12	28	13	10

RS2025/7-IP



Socket Set on Rail
Steckschlüsselsatz auf Schiene
Jeu de douilles sur rail

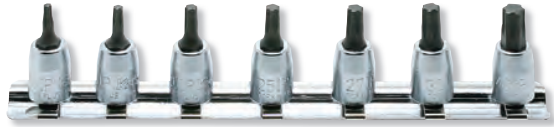

RS2025/7-IP	7 Pieces set/Rail 150mm	(g)
10IP, 15IP, 20IP, 25IP, 27IP, 30IP, 40IP		119

TORXPLUS® (IP)

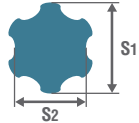

IP	8IP	9IP	10IP	15IP	20IP	25IP	27IP	30IP	40IP	45IP	50IP	55IP	60IP	70IP
S ₁ (ref. mm)	2.3	2.5	2.7	3.3	3.9	4.5	5.0	5.6	6.7	7.9	8.9	11.3	13.3	15.6
S ₂ (ref. mm)	1.8	1.9	2.1	2.5	3.0	3.4	3.9	4.3	5.2	6.2	6.9	9.0	10.4	12.3

2025-28 (IPR)



Tamper-Resistance TORXPLUS® Bit Sockets
Tamper-Resistance TORXPLUS® Bit-Steckschlüssel
Douilles tournevis TORXPLUS® avec trou

TORXplus

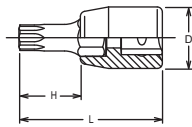

2025-28 (IPR)	D (mm)	H (mm)	L (mm)	(g)	(pcs.)
8IPR	11.9	12	28	10	10
9IPR	11.9	12	28	10	10
10IPR	11.9	12	28	10	10
15IPR	11.9	12	28	10	10
20IPR	11.9	12	28	11	10
25IPR	11.9	12	28	11	10
27IPR	11.9	12	28	12	10
30IPR	11.9	12	28	12	10
40IPR	13.1	12	28	13	10

RS2025/7-IPR



Socket Set on Rail
Steckschlüsselsatz auf Schiene
Jeu de douilles sur rail



RS2025/7-IPR	7 Pieces set/Rail 150mm	(g)
10IPR, 15IPR, 20IPR, 25IPR, 27IPR, 30IPR, 40IPR		119

TORXPLUS® (IPR)

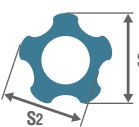

IPR	8IPR	9IPR	10IPR	15IPR	20IPR	25IPR	27IPR	30IPR	40IPR	45IPR	50IPR	55IPR
S ₁ (ref. mm)	2.2	2.4	2.6	3.1	3.6	4.1	4.7	5.2	6.3	7.4	8.4	10.6
S ₂ (ref. mm)	2.0	2.2	2.4	2.8	3.3	3.8	4.3	4.8	5.7	6.7	7.6	9.7

2137



Bit Holder
Klingenhalter
Porte-embouts

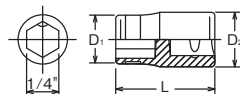

2137	D ₁ (mm)	D ₂ (mm)	L (mm)	(g)	(pcs.)
2137	12	12	22.5	13	10

For DIN3126 C6.3 Bits
Für DIN3126 C6.3 Bits
Pour DIN3126 C6.3 Embouts

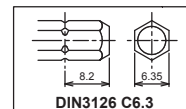

2138



Bit Holder
Klingenhalter
Porte-embouts

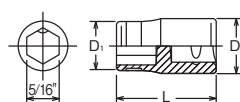

2138	D ₁ (mm)	D ₂ (mm)	L (mm)	(g)	(pcs.)
2138	16	16	26	32	10

For DIN3126 C8 Bits
Für DIN3126 C8 Bits
Pour DIN3126 C8 Embouts

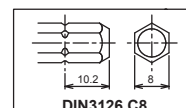

1/4" Hand Sockets Hand Steckschlüssel Douilles à main

Z-SERIES
HAND
TITANIUM
ACCESSORIES
SCREWDRIVERS
IMPACT
SLEEVE-DRIVE
PROTECTOR
INDUSTRIAL
AUTOMOTIVE
MOTORCYCLE
CONSTRUCTION
SPARE PART



2753PS Reversible Ratchet (Short)
Knarre kurz, verstellbar
Cliquet courte, réversible



	D (mm)	T (mm)	H (mm)	L (mm)	(g)	(pcs.)
2753PS	22	18.7	11.4	75	55	5

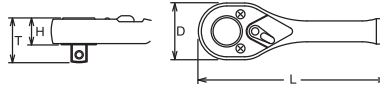

2753J Reversible Ratchet
Knarre, verstellbar
Cliquet, réversible



2753P Reversible Ratchet
Knarre, verstellbar
Cliquet, réversible



2753N Reversible Ratchet
Knarre, verstellbar
Cliquet, réversible



	D (mm)	T (mm)	H (mm)	L (mm)	(g)	(pcs.)
2753J	22	18.7	11.4	115	77	1
2753P	22	18.7	11.4	115	87	1
2753N	22	18.7	11.4	115	90	1

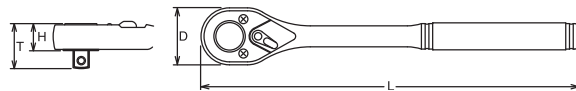

2753P-160 Reversible Ratchet (Long) ⚠
Verstellbare Knarre, lang
Cliquet réversible, longue



	D (mm)	T (mm)	H (mm)	L (mm)	(g)	(pcs.)
2753P-160	22	18.7	11.4	160	107	1

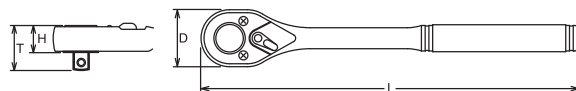

⚠ 2753P-160 have longer handle than standard, and can be loaded to excessive torque value. In the interest of your own safety always apply load evenly and progressively to avoid breakage and possible injury.

Hand Sockets Hand Steckschlüssel Douilles à main

1/4"

2753JB Reversible Ratchet with quick release button
Knarre, verstellbar mit Entriegelungsknopf
Cliquet, réversible avec bouton de débrayage



* Renewal Kits → 2753BRK → P318

2753PB Reversible Ratchet with quick release button
Knarre, verstellbar mit Entriegelungsknopf
Cliquet, réversible avec bouton de débrayage



* Renewal Kits → 2753BRK → P318

2753NB Reversible Ratchet with quick release button
Knarre, verstellbar mit Entriegelungsknopf
Cliquet, réversible avec bouton de débrayage



* Renewal Kits → 2753BRK → P318

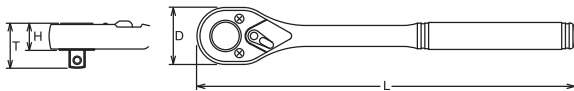

	D (mm)	T (mm)	H (mm)	L (mm)	(g)	(pce.)
2753JB	22	18.7	11.4	115	77	1
2753PB	22	18.7	11.4	115	87	1
2753NB	22	18.7	11.4	115	90	1

Reversible Ratchet with Quick Release Button :
Sockets and accessories are safely locked. By pushing the button the sockets or extension bars are released from the ratchet.

Umstellbare Knarre mit Entriegelungsknopf :
Steckschlüssel und Zubehörteile werden sicher und fest gehalten. Bei Drücken des Knopfes lösen sich die Teile.

Cliquet réversible à verrouillage :
Les douilles et accessoires ne peuvent plus tomber. Une pression du pouce sur le bouton suffit pour les libérer.

2774JS Flexible Ratchet, reversible
Gelenk-Knarre, verstellbar
Cliquet articulé, réversible



* Renewal Kits → 2753RK → P318

2774PS Flexible Ratchet, reversible
Gelenk-Knarre, verstellbar
Cliquet articulé, réversible



* Renewal Kits → 2753RK → P318

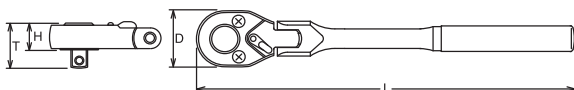

	D (mm)	T (mm)	H (mm)	L (mm)	(g)	(pce.)
2774JS	22	18.7	11.4	116	113	1
2774PS	22	18.7	11.4	116	110	1

Z-SERIES

HAND

TITANIUM

SCREWDRIVERS ACCESSORIES

IMPACT

SLEEVE-DRIVE

PROTECTOR

INDUSTRIAL

AUTOMOTIVE

MOTORCYCLE

CONSTRUCTION

SPARE PART

1/4" Hand Sockets Hand Steckschlüssel Douilles à main



* Renewal Kits → 2753RK → P318

2774J Flexible Ratchet, reversible
Gelenk-Knarre, verstellbar
Cliquet articulé, réversible



* Renewal Kits → 2753RK → P318

2774P Flexible Ratchet, reversible
Gelenk-Knarre, verstellbar
Cliquet articulé, réversible

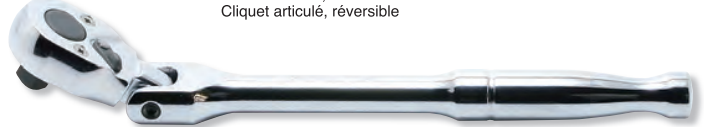

* Renewal Kits → 2753RK → P318

2774N Flexible Ratchet, reversible
Gelenk-Knarre, verstellbar
Cliquet articulé, réversible



	D (mm)	T (mm)	H (mm)	L (mm)	(g)	(pcs.)
2774J	22	18.7	11.4	161	130	1
2774P	22	18.7	11.4	161	126	1
2774N	22	18.7	11.4	161	130	1

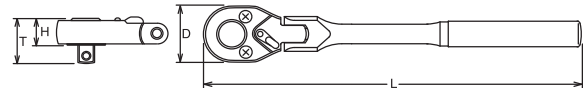

* Renewal Kits → 2755RK → P318

2755 Ratchet Adaptor
Aufsteckknarre
Cliquet adaptable

	D (mm)	L (mm)	(g)	(pcs.)
2755	26	40	80	10

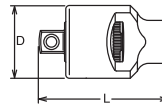

	D (mm)	L (mm)	(g)	(pcs.)
2756	22	20	19	10

2756 Quick Spinner
Rändel-Drehscheibe
Lanceur

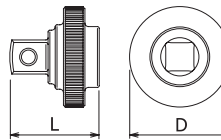

2762 Flexible Extension Bar
Biegsame Verlängerung
Rallonge flexible

	D (mm)	L (mm)	(g)	(pcs.)
2762	13	300	90	2

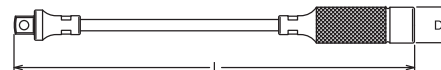

	D (mm)	L (mm)	(g)	(pcs.)
2120	14.3	17.5	21	10

2120 Magnetic Head
Magnetkopf
Tête aimantée

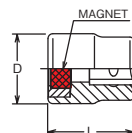

Z-SERIES
HAND
TITANIUM
ACCESSORIES
SCREWDRIVERS
IMPACT
SLEEVE-DRIVE
PROTECTOR
INDUSTRIAL
AUTOMOTIVE
MOTORCYCLE
CONSTRUCTION
SPARE PART

Hand Sockets Hand Steckschlüssel Douilles à main **1/4"**

2760 Extension Bars Verlängerungen Rallonges

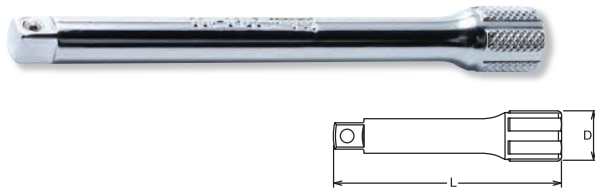

PK2760/6 Extension Set in Plastic Box Verlängerungen in Kunststoffkassette Jeu de rallonges en boîte plastique



2763 Wobble-Fix Extension Bars Winkel-Verlängerungen Rallonges angulaires

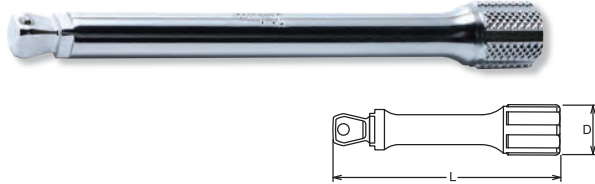
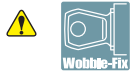

PK2763/6 Wobble-Fix Extension Bars in Plastic Box Winkel-Verlängerungen in Kunststoffkassette Jeu de rallonges angulaires en boîte plastique



⚠ The Wobble-Fix Extension Bar has less strength than normal extension bar due to its specific design with a reduced square drive. Make sure to use it correctly.

Die Wobble-Fix Verlängerungen haben aufgrund ihrer speziellen Konstruktion mit einem reduzierten Vierkantantrieb eine geringere Festigkeit als eine normale Verlängerung. Achten Sie darauf, sie richtig zu verwenden.

La barre d'extension wobble-fix est moins résistante qu'une barre d'extension normale en raison de sa conception spécifique avec un carré d'entraînement réduit. Veuillez à l'utiliser correctement.

2768J Hinge Handle Gelenkgriff Poignée articulée



2768P Hinge Handle Gelenkgriff Poignée articulée

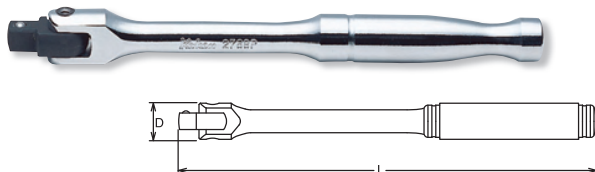

	D (mm)	L (mm)	(g)	(pcs.)
2760-28	12.3	28	14	10
2760-50	12.3	50	23	10
2760-75	12.3	75	35	10
2760-100	12.3	100	44	10
2760-150	12.3	150	63	10
2760-200	12.3	200	83	10
2760-250	12.3	250	103	10
2760-300	12.3	300	122	2
2760-350	12.3	350	145	2
2760-400	12.3	400	160	2
2760-600	12.3	600	240	2

PK2760/6 6 Pieces Set/△=430g PLASTIC TRAY

Extension Bars
2760 Extension Bars 28, 50, 100, 150, 200, 250

Rotation and general handling of extensions with oily hands is greatly improved with the **Koken** developed 6 point knurling. Also the **Koken** 6 point knurling stops the extensions from rolling around the work area.

Durch die von **Koken** entwickelte 6 fache Rändelung wird die Handhabung deutlich erleichtert. Außerdem wird das Herumrollen der Verlängerungen wirksam verhindert.

La manipulation des rallonges est grandement facilitée par le profil moleté développé par **Koken**. Ce même profil empêche le roulement intempêtif des rallonges sur le plan de travail.



	D (mm)	L (mm)	(g)	(pcs.)
2763-28	12.3	28	14	10
2763-50	12.3	50	23	10
2763-75	12.3	75	33	10
2763-100	12.3	100	43	10
2763-150	12.3	150	62	10
2763-200	12.3	200	80	10
2763-250	12.3	250	100	10

PK2763/6 6 Pieces Set/△=420g PLASTIC TRAY

Extension Bars
2763 Wobble-Fix Extension Bars 28, 50, 100, 150, 200, 250

Wobble-Fix Extension Bar
Two way usage
a) In a fixed position, as a normal extension bar
b) In a half-fixed position, as a flexible extension bar providing a 15° angle operation

Winkel-Verlängerungen
Winkelverlängerungen lassen sich in zwei Einstellungen verwenden
a) voll eingesteckt und starr,
b) halb eingesteckt, mit einem Arbeitswinkel von 15°.

Rallonges angulaires
Deux utilisations possibles
a) comme rallonge normale, dans une position fixe
b) comme une rallonge angulaire avec une possibilité d'inclinaison jusqu'à 15°

* Renewal Kits → 2768RK → P321

* Renewal Kits → 2768RK → P321

	D (mm)	L (mm)	(g)	(pcs.)
2768J	14	130	73	5
2768P	14	130	70	10

1/4" Hand Sockets Hand Steckschlüssel Douilles à main

2769N	H (mm)	L (mm)	(g)	(pcs.)
150	50	150	73	2
220	120	220	100	2

 Plastic or rubber handles are not intended to act as insulation.
Plastik- oder Gummigriffe stellen keinen Isolierschutz dar.
Les poignées en plastique ou en caoutchouc ne garantissent aucune isolation électrique.

2769N-150 / -220 Spin Type Handle Drehgriff Poignée emmanchée

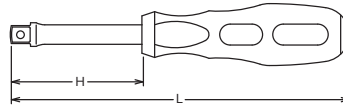

2769NWF	H (mm)	L (mm)	(g)	(pcs.)
150	50	150	73	2
220	120	220	100	2

Wobble-Fix Extension Bar
Two way usage:
One for as a flexible extension bar to provide at 15° angle operation, the other for use as a normal extension bar.

Woble-Fix Verlängerung
Zwei Verwendungsmöglichkeiten:
zum einen als flexible Verlängerung für den Betrieb in einem Winkel von 15°, zum anderen als normale Verlängerung.

Barre d'extension Woble-Fix
Utilisation double:
l'une comme barre d'extension flexible pour fournir un angle de 15°, l'autre comme barre d'extension normale.

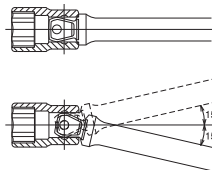

2769NWF-150 / -220 Spin Type Handle(Wobble-Fix) Drehgriff, Wobble-Fix Poignée emmanchée, angulaire

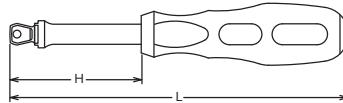

2769H Folding Socket Driver Klapp-Drehgriff Poignée tournevis articulée

2769H	L (mm)	(g)	(pcs.)
2769H	160	180	5

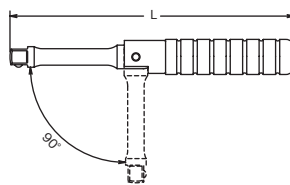
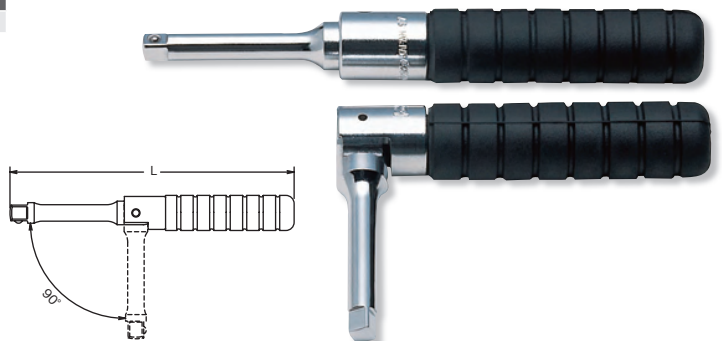

Z-SERIES
HAND
TITANIUM
ACCESSORIES
SCREWDRIVERS
IMPACT
SLEEVE-DRIVE
PROTECTOR
INDUSTRIAL
AUTOMOTIVE
MOTORCYCLE
CONSTRUCTION
SPARE PART

Hand Sockets
Hand Steckschlüssel
Douilles à main

1/4"

2770 Universal Joint
Gelenk-Einsatz
Cardan universel

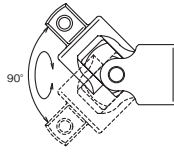
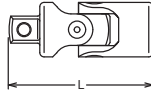

	L (mm)	(g)	(pcs.)
2770	33	20	10

2771 Universal Joint
Gelenk-Einsatz
Joint articulé

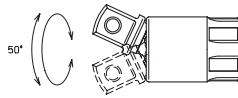
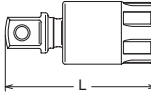

	L (mm)	(g)	(pcs.)
2771	31	20	10



UNIVERSAL JOINT

2780 Speed Handle
Winde
Vilebrequin

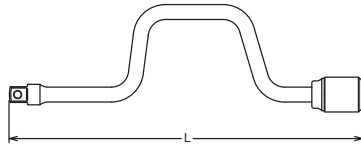

	L (mm)	(g)	(pcs.)
2780	350	250	1

2785 T-Handle
T-Griff
Poignée coulissante

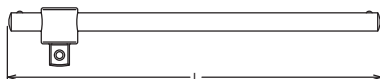

	L (mm)	(g)	(pcs.)
2785	115	36	10

2233A Adaptor
Verbindungsstück
Augmentateur

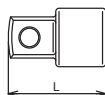

	(sq.)	(sq.)	L (mm)	(g)	(pcs.)
2233A	1/4"	3/8"	22	16	10

Z-SERIES

HAND

TITANIUM

SCREWDRIVERS ACCESSORIES

IMPACT

SLEEVE-DRIVE

PROTECTOR

INDUSTRIAL

AUTOMOTIVE





MOTORCYCLE

CONSTRUCTION

SPARE PART





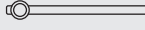

1/4"

Hand Sockets
Hand Steckschlüssel
Douilles à main

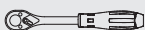
ESH2001		16 Pieces Set/△=630g	
METAL CASE:W160xH100xT28mm			
Sockets	Accessories		
2410M Surface Drive Sockets 4, 5, 5.5, 6, 7, 8, 9, 10, 11, 12, 13		2753J	
		2763-50	
		2760-150	
		2770	
		2785	

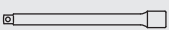

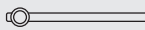

ESH2001 Socket Set
Steckschlüssel Satz
Jeu de clés à douille



ENH2003		26 Pieces Set/△=980g	
METAL CASE:W310xH86xT40mm			
Sockets	Accessories		
2400M 6-pt. Sockets 5.5, 6, 7, 8, 9, 10, 11, 12, 13, 14		2753J	
108P PH Bits 1, 2		2760-50	
108S Slotted Bits 4, 6, 8		2760-150	
108H Hex Bits 3, 4, 5, 6		2769N-150	
		2770	
		2785	
		2137	

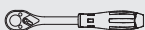

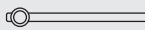

ENH2003 Socket Set
Steckschlüssel Satz
Jeu de clés à douille





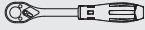

2251M		17 Pieces Set/△=725g	
METAL CASE:W192xH122xT30mm			
Sockets	Accessories		
2400M 6-pt. Sockets 4, 4.5, 5, 5.5, 6, 7, 8, 9, 10, 11, 13		2753J	
		2760-50	
		2760-150	
		2768J	
		2770	
		2785	

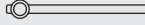
2251M / 2251A Socket Set
Steckschlüssel Satz
Jeu de clés à douille

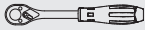

2251A		15 Pieces Set/△=700g	
METAL CASE:W192xH122xT30mm			
Sockets	Accessories		
2400A 6-pt. Sockets 3/16, 7/32, 1/4, 9/32, 5/16, 11/32, 3/8, 7/16, 1/2		2753J	
		2760-50	
		2760-150	
		2768J	
		2770	
		2785	

2258M Socket Set
Steckschlüssel Satz
Jeu de clés à douille

2258M		31 Pieces Set/△=965g	
METAL CASE:W240xH100xT32mm			
Sockets	Accessories		
2400M 6-pt. Sockets 4, 4.5, 5, 5.5, 6, 7, 8, 9, 10, 11, 13		2753J	
2000.28 Bit Sockets 1, 2, 3		2760-100	
2005.25 Bit Sockets 4, 6		2769N-150	
2010M.25 Bit Sockets 3, 4, 5, 6, 8		2770	
2025.28 Bit Sockets T10, T15, T20, T25, T30		2785	



Z-SERIES
HAND
TITANIUM
ACCESSORIES
SCREWDRIVERS
IMPACT
SLEEVE-DRIVE
PROTECTOR
INDUSTRIAL
AUTOMOTIVE
MOTORCYCLE
CONSTRUCTION
SPARE PART

Hand Sockets Hand Steckschlüssel Douilles à main

1/4"

2259M Socket Set
Steckschlüssel Satz
Jeu de clés à douille



2259M		31 Pieces Set/△=991g	
METAL CASE:W240xH100xT32mm			
Sockets		Accessories	
	2400M 6-pt. Sockets 4, 4.5, 5, 5.5, 6, 7, 8, 9, 10, 11, 13		2774JS
	2000.28 Bit Sockets 1, 2, 3		2760-100
	2005.25 Bit Sockets 4, 6		2769N-150
	2010M.25 Bit Sockets 3, 4, 5, 6, 8		2770
	2025.28 Bit Sockets T10, T15, T20, T25, T30		2785

2263A Socket Set
Steckschlüssel Satz
Jeu de clés à douille



2263A		29 Pieces Set/△=940g	
METAL CASE:W240xH100xT32mm			
Sockets		Accessories	
	2400A 6-pt. Sockets 1/8, 5/32, 3/16, 7/32, 1/4, 9/32, 5/16, 11/32, 3/8, 7/16, 1/2		2753N
	2000.28 Bit Sockets 1, 2, 3		2760-100
	2010A.25 Bit Sockets 1/8, 5/32, 3/16, 7/32, 1/4, 9/32, 5/16		2770
	2025.28 Bit Sockets T10, T15, T20, T25, T30		2785

2275 Socket Set
Steckschlüssel Satz
Jeu de clés à douille



2275		19 Pieces Set/△=880g	
METAL CASE:W192xH122xT30mm			
Sockets		Accessories	
	2400M 6-pt. Sockets 5.5, 6, 7, 8, 10, 12, 13		2753J
	2000.28 Bit Sockets 1, 2, 3		2763-50
	2005.25 Bit Sockets 6, 8		2769N-150
	2010M.25 Bit Sockets 3, 4, 5, 6		

2276 Socket Set with Bits and Accessories
Bit Satz mit Zubehör
Jeu d'embouts et avec accessoires



2276		19 Pieces Set/△=640g	
METAL CASE:W192xH122xT30mm			
Bits		Accessories	
	108P PH Bits 1, 2, 3		2753PS
	108S Slotted Bits 4, 5, 6		2769N-150
	108H Hex Bits 3, 4, 5, 6		2137
	108T TORX® Bits T10, T15, T20, T25, T27, T30		

2277 Socket Set
Steckschlüssel Satz
Jeu de clés à douille



2277		21 Pieces Set/△=1,240g	
METAL CASE:W310xH86xT50mm			
Sockets		Accessories	
	2400M 6-pt. Sockets 5.5, 6, 7, 8, 9, 10, 11, 12, 13		2753J
	2300M 6-pt. Deep Sockets 5.5, 6, 7, 8, 9, 10, 11, 12, 13		2763-75
			2769N-150

Z-SERIES

HAND

TITANIUM

SCREWDRIVERS ACCESSORIES

IMPACT

SLEEVE-DRIVE

PROTECTOR

INDUSTRIAL



AUTOMOTIVE

MOTORCYCLE

CONSTRUCTION



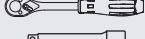
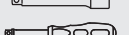

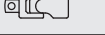
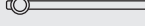

SPARE PART

1/4" Hand Sockets Hand Steckschlüssel Douilles à main

P2201AM		25 Pieces Set/△=800g	
PLASTIC CASE:W245xH120xT45mm			
Sockets		Accessories	
	2400M 6-pt. Sockets 4, 5, 5.5, 6, 7, 8, 9, 10, 11, 12, 13		2753J
			2760-100
	2400A 6-pt. Sockets 3/16, 7/32, 1/4, 9/32, 5/16, 11/32, 3/8, 7/16, 1/2		2769N-150
			2770
			2785





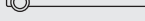



P2201AM Socket Set
Steckschlüssel Satz
Jeu de clés à douille

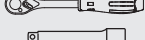

P2251M		18 Pieces Set/△=770g	
PLASTIC CASE:W245xH120xT45mm			
Sockets		Accessories	
	2400M 6-pt. Sockets 4, 4.5, 5, 5.5, 6, 7, 8, 9, 10, 11, 12, 13		2753J
			2760-50
			2760-150
			2768J
			2770
			2785

P2251M Socket Set
Steckschlüssel Satz
Jeu de clés à douille



P2258M		31 Pieces Set/△=860g	
PLASTIC CASE:W245xH120xT45mm			
Sockets		Accessories	
	2400M 6-pt. Sockets 4, 5, 5.5, 6, 7, 8, 9, 10, 11, 12, 13		2753J
	2000.28 Bit Sockets 1, 2, 3		2760-100
	2005.25 Bit Sockets 4, 6		2769N-150
	2010M.25 Bit Sockets 3, 4, 5, 6, 8		2770
	2025.28 Bit Sockets T10, T15, T20, T25, T30		2785

P2258M Socket Set
Steckschlüssel Satz
Jeu de clés à douille



ABS Case - PE foam insert
Kunststoffkassette - Weichschaumeinlage
Coffret en ABS - Inserts en mousse

Z-SERIES
HAND
TITANIUM
ACCESSORIES
SCREWDRIVERS
IMPACT
SLEEVE-DRIVE
PROTECTOR
INDUSTRIAL
AUTOMOTIVE
MOTORCYCLE
CONSTRUCTION
SPARE PART

3400M / 3400A

6-point Sockets
6-kant Steckschlüssel
Douilles 6-pans



FLAT DRIVE®

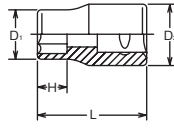

3405M / 3405A

12-point Sockets
12-kant Steckschlüssel
Douilles 12-pans

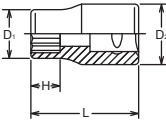

FLAT DRIVE®

Flat drive is designed to guarantee a flat surface contact between the socket and the bolt/nut. The Flat contact reduces wear and allows to transmit a higher torque value. The Flat Drive System is also used for the square drive end as well as the hexagonal or bi-hexagonal openings of the socket.

Das Flat Drive Design sorgt für die optimale Kraftübertragung zwischen den Flächen des Steckschlüssels und der Schraube. Dies erlaubt eine Übertragung von höheren Drehmomenten. Das Flat Drive System findet ebenfalls bei allen Antriebsvierkanten sowie bei 6-kant und 12-kant Profilen Verwendung.

Le profil Flat Drive garantit un contact optimal entre la douille et l'écrou. Ce contact «à plat» réduit l'usure et permet la transmission d'un couple plus élevé. Ce système Flat Drive est utilisé pour tous les carrés conducteurs ainsi que pour toutes nos douilles 6-pans et 12-pans.

RS3400M/12

Socket Set on Rail
Steckschlüsselsatz auf Schiene
Jeu de douilles sur rail



RS3405A/9

Socket Set on Rail
Steckschlüsselsatz auf Schiene
Jeu de douilles sur rail



3400M 3405M (mm)	D ₁ (mm)	D ₂ (mm)	H (mm)	L (mm)	(g)	(pcs.)
5	8.3	17.3	5	26	20	10
5.5	8.9	17.3	5.5	26	20	10
6	9.9	17.3	6	26	20	10
7	10.8	17.3	6.5	26	20	10
8	12	17.3	7	26	22	10
9	13.3	17.3	7.5	26	23	10
10	14.5	17.3	8	26	24	10
11	15.8	17.3	8.5	26	25	10
12	16.8	17.3	9	26	25	10
13	18	17	9.5	26	24	10
14	19.5	18.5	11	27	31	10
15	20.8	19.5	11.5	28	39	10
16	22	20	12	28	42	10
17	23.3	21.5	12.5	29	51	10
18	24.5	22.5	13	30	51	10
19	25.8	23.5	13.5	30	63	10
20	27	24.5	14	31	75	10
21	28	26	14.5	32	77	10
22	29.5	26.5	15	32	82	10
23	30.8	27.5	15.5	33	95	10
24	32	28.5	16	34	102	10
25	33.3	29.5	16.5	34	115	5
26	34.5	30.5	17	35	129	5

3400A 3405A (inch)	D ₁ (mm)	D ₂ (mm)	H (mm)	L (mm)	(g)	(pcs.)
3/16	8.3	17.3	5	26	20	10
1/4	10.3	17.3	6	26	20	10
9/32	10.8	17.3	6.5	26	20	10
5/16	12	17.3	7	26	22	10
11/32	13.3	17.3	7.5	26	23	10
3/8	13.9	17.3	8	26	23	10
13/32	13.3	17.3	7.5	26	23	10
7/16	15.8	17.3	8.5	26	25	10
1/2	18	17	9.5	26	24	10
9/16	19.5	18.5	11	27	31	10
19/32	20.8	19.5	11.5	28	39	10
5/8	22	20	12	28	42	10
11/16	24.5	22.5	13	30	51	10
3/4	25.8	23.5	13.5	30	63	10
25/32	27	24.5	14	31	75	10
13/16	28	26	14.5	32	77	10
7/8	29.5	26.5	15	32	82	10
15/16	32	28.5	16	34	102	10
1	34.5	30.5	17	35	132	5

RS3400M/12	12 Pieces Set/Rail 300mm	(g)
8, 9, 10, 11, 12, 13, 14, 15, 16, 17, 18, 19		465

RS3405M/12	12 Pieces Set/Rail 300mm	(g)
8, 9, 10, 11, 12, 13, 14, 15, 16, 17, 18, 19		465

RS3400A/9	9 Pieces Set/Rail 200mm	(g)
1/4, 5/16, 3/8, 7/16, 1/2, 9/16, 5/8, 11/16, 3/4		333

RS3405A/9	9 Pieces Set/Rail 200mm	(g)
1/4, 5/16, 3/8, 7/16, 1/2, 9/16, 5/8, 11/16, 3/4		333

3410M (mm)	D ₁ (mm)	D ₂ (mm)	H (mm)	L (mm)	(g)	(pcs.)
5.5	8.9	17.3	5.5	26	20	10
6	9.9	17.3	6	26	20	10
7	10.8	17.3	6.5	26	20	10
8	12	17.3	7	26	22	10
9	13.3	17.3	7.5	26	23	10
10	14.5	17.3	8	26	24	10
11	15.8	17.3	8.5	26	25	10
12	16.8	17.3	9	26	25	10
13	18	17	9.5	26	24	10
14	19.5	18.5	11	27	31	10
15	20.8	19.5	11.5	28	39	10
16	22	20	12	28	42	10
17	23.3	21.5	12.5	29	51	10
18	24.5	22.5	13	30	51	10
19	25.8	23.5	13.5	30	63	10
20	27	24.5	14	31	75	10
21	28	26	14.5	32	77	10
22	29.5	26.5	15	32	82	10
23	30.8	27.5	15.5	33	95	10
24	32	28.5	16	34	102	10



3410M

Surface Drive Sockets
Surface Drive Steckschlüssel
Douilles, Surface Drive

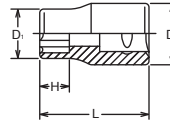

SURFACE DRIVE

Surface drive sockets are designed to retain contact with the flat sides of the nut in order to transmit high torque and reduce nut wear. These sockets are ideal for using on polished nuts, aluminum nuts and nuts with worn out points.

Das Profil unserer Surface-Drive Steckschlüssel greift die Schraube an deren Flächen. Dies sichert eine höhere Kraftübertragung und verhindert ein Durchrutschen des Steckschlüssels. Diese Steckschlüssel eignen sich besonders für polierte Schrauben, Aluminium Schrauben und Schrauben bei denen die Ecken bereits abgerundet sind.

Notre profil Surface Drive assure le contact entre la douille et les plats de l'écrou. Ceci réduit l'usure et permet la transmission d'un couple plus élevé. C'est une solution idéale pour les écrous polies, celles en aluminium ou arrondies.

RS3410M/12	12 Pieces Set/Rail 300mm	(g)
8, 9, 10, 11, 12, 13, 14, 15, 16, 17, 18, 19		468

RS3410M/12

Socket Set on Rail
Steckschlüsselsatz auf Schiene
Jeu de douilles sur rail



3400W 3405W (W)	D ₁ (mm)	D ₂ (mm)	H (mm)	L (mm)	(g)	(pcs.)
1/8	13.3	17.3	7.5	26	22	10
3/16	15.8	17.3	8.5	26	25	10
1/4	18	17	9.5	26	24	10
5/16	20.8	19.5	11.5	28	39	10
3/8	24.5	22.5	13	30	51	10
7/16	28	26	14.5	32	81	10
1/2	30.8	27.5	15.5	33	103	10
9/16	34.5	30.5	17	35	128	5

3400W

6-point Whitworth Sockets
6-kant Steckschlüssel, Whitworth
Douilles à 6-pans Whitworth

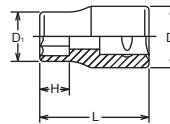

3405W

12-point Whitworth Sockets
12-kant Steckschlüssel, Whitworth
Douilles à 12-pans Whitworth

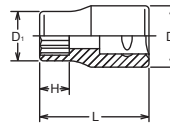

RS3400W/7	7 Pieces Set/Rail 200mm	(g)
1/8, 3/16, 1/4, 5/16, 3/8, 7/16, 1/2		389

RS3400W/7 RS3405W/7

Socket Set on Rail
Steckschlüsselsatz auf Schiene
Jeu de douilles sur rail



RS3405W/7	7 Pieces Set/Rail 200mm	(g)
1/8, 3/16, 1/4, 5/16, 3/8, 7/16, 1/2		389

BS W	S	BS		3/16BS	1/4BS	5/16BS	3/8BS	7/16BS	1/2BS	9/16BS	5/8BS	11/16BS	3/4BS	7/8BS
		BS-W	W	1/8W	3/16W	1/4W	5/16W	3/8W	7/16W	1/2W	9/16W	5/8W	11/16W	3/4W
S	(ref. mm)	8.64	11.30	13.34	15.24	18.03	20.83	23.37	25.65	27.94	30.48	33.35		

3415M / 3415A

Double 4-point Sockets
Doppelvierkant Steckschlüssel
Douilles 4-pans, doubles

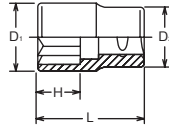

3425

TORX® Sockets
TORX® Steckschlüssel
Douilles TORX®

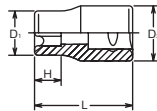

RS3425/9

Socket Set on Rail
Steckschlüsselsatz auf Schiene
Jeu de douilles sur rail



RSX425/14

Socket Set on Rail
Steckschlüsselsatz auf Schiene
Jeu de douilles sur rail



TORX® (E)

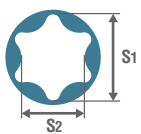

E	E4	E5	E6	E7	E8	E10	E11	E12	E14	E16	E18	E20	E22	E24	E26	E28	E30	E32
S ₁ (ref. mm)	3.7	4.6	5.6	6.1	7.4	9.3	9.9	11.0	12.8	14.6	16.5	18.3	20.1	22.0	23.7	25.5	27.3	29.0
S ₂ (ref. mm)	2.7	3.3	4.0	4.3	5.3	6.8	7.1	7.9	9.2	10.5	11.9	13.2	14.8	15.7	17.5	18.3	20.0	21.3

3400LH

LHSTIX® Sockets
Steckschlüssel mit LHSTIX® Profil
Douilles au profil LHSTIX®

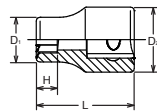

RS3400LH/7

Socket Set on Rail
Steckschlüsselsatz auf Schiene
Jeu de douilles sur rail



LHSTIX®

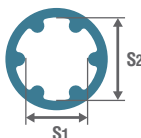

LH-S	LH-5S	LH-6S	LH-8S	LH-10S	LH-12S	LH-14S	LH-16S
S ₁ (ref. mm)	5.6	6.8	9.0	11.3	13.6	15.8	18.1
S ₂ (ref. mm)	7.5	9.0	12.0	15.0	18.0	21.0	24.0

3415M (mm)	D ₁ (mm)	D ₂ (mm)	H (mm)	L (mm)	(g)	(pcs.)
5.5	10.8	17.4	5.5	26	21	10
6	12	17.3	6	26	26	10
7	13.3	17.4	6.5	26	26	10
8	14.5	17.3	7	26	26	10
10	16.8	17.3	8	26	27	10
12	20.8	19.5	9	27	43	10
13	21.9	20	9.5	27	46	10

3415A (inch)	D ₁ (mm)	D ₂ (mm)	H (mm)	L (mm)	(g)	(pcs.)
1/4	12	17.3	6	26	24	10
5/16	14.5	17.3	7	26	26	10
11/32	15.8	17.3	7.5	26	27	10
3/8	16.8	17.3	8	26	27	10
7/16	19.5	18.5	8.5	27	37	10
1/2	22	20	9.5	27	46	10

3425 (E)	D ₁ (mm)	D ₂ (mm)	H (mm)	L (mm)	(g)	(pcs.)
E 4	5.6	17.3	4.6	26	18	10
E 5	7	17.3	5.2	26	20	10
E 6	8.3	17.3	5.4	26	21	10
E 7	8.9	17.3	6.6	26	22	10
E 8	9.9	17.3	7	26	23	10
E10	12	17.3	8.2	26	24	10
E11	13.3	17.3	8.7	26	25	10
E12	14.5	17.3	9.3	26	26	10
E14	15.8	17.3	10.6	26	27	10
E16	18	17	11.8	26	27	10

RS3425/9	9 Pieces Set/Rail 200mm	(g)
E4, E5, E6, E7, E8, E10, E12, E14, E16		239

RSX425/14	14 Pieces Set/Rail 300mm	(g)
2425	1/4"	E4, E5, E6, E7, E8
3425	3/8"	E10, E11, E12, E14
4425	1/2"	E16, E18, E20, E22, E24

3400LH (LH-S)	D ₁ (mm)	D ₂ (mm)	H (mm)	L (mm)	(g)	(pcs.)
5S	10.8	17.3	5	26	20	10
6S	12	17.3	5.6	26	22	10
8S	15.8	17.3	6.8	26	25	10
10S	18	17	8	26	25	10
12S	22	20	9.2	28	42	10
14S	24.5	22.5	10.4	30	51	10
16S	28	26	11.6	32	77	10

RS3400LH/7	7 Pieces Set/Rail 150mm	(g)
5S, 6S, 8S, 10S, 12S, 14S, 16S		315

TORX® is a registered trademark of CAMCAR Innovations.
TORX® ist ein registriertes Markenzeichen der Firma CAMCAR Innovations.
TORX® est une marque déposée de CAMCAR Innovations.

LHSTIX® is a registered trademark of OSG SYSTEM PRODUCTS CO., LTD.
LHSTIX® ist ein registriertes Markenzeichen der Firma OSG SYSTEM PRODUCTS CO., LTD.
LHSTIX® est une marque déposée de OSG SYSTEM PRODUCTS CO., LTD.

3/8"

Hand Sockets
Hand Steckschlüssel
Douilles à main

Z-SERIES
HAND
TITANIUM
ACCESSORIES
SCREWDRIVERS
IMPACT
SLEEVE-DRIVE
PROTECTOR
INDUSTRIAL
AUTOMOTIVE
MOTORCYCLE
CONSTRUCTION
SPARE PART

3450M (mm)	D ₁ (mm)	D ₂ (mm)	H (mm)	L (mm)	(g)	(pcs.)
8	12	17.3	5	26	21	10
10	14.5	17.3	6	26	24	10
11	15.8	17.3	6.5	26	26	10
12	16.8	17.3	7	26	26	10
13	18	17	8	26	28	10
14	19.5	18.5	8.5	27	34	10
15	20.8	19.5	9	27	42	10
16	22	20	9	27	50	10
17	23.3	21.5	9.5	28	62	10
18	24.5	22.5	10.5	29	64	10
19	25.8	23.3	11.5	29	66	10
21	28	26	12	29	85	10
22	29.5	27	12.5	29	90	10
24	32	30	14.5	31	102	10



3450M / 3450A



Nut Grip Sockets **Nut Grip**[®]
Steckschlüssel mit 2-facher Kugelhalterung
Douilles à billes de retenue

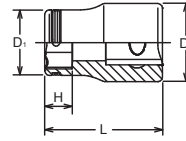

NUT GRIP[®]

Twin balls at the 6-point opening hold bolt/nut tightly for safe and reliable work.

Die zwei Kugeln in der 6-kant Öffnung unserer NUT GRIP Steckschlüssel halten die Schraube sicher im Steckschlüssel. Dies erlaubt ein Arbeiten auch an schwer zugänglichen Stellen.

Les 2 billes dans l'ouverture du 6-pans de la douille retiennent l'écrou de manière sûre et efficace.

3450A (inch)	D ₁ (mm)	D ₂ (mm)	H (mm)	L (mm)	(g)	(pcs.)
1/4	10.3	17.4	3.5	26	19	10
5/16	12	17.4	5	26	21	10
3/8	13.9	17.4	6	26	24	10
7/16	15.8	17.4	6.5	26	26	10
1/2	18	17	8	26	28	10
9/16	19.5	18.5	8.5	27	34	10
5/8	22	20	9	27	50	10
11/16	24.6	22.5	10.5	29	64	10
3/4	26	23.5	11.5	29	66	10

RS3450M/8	8 Pieces Set/Rail 200mm	(g)
8, 10, 11, 12, 13, 14, 17, 19		310

RS3450M/10	10 Pieces Set/Rail 250mm	(g)
10, 11, 12, 13, 14, 15, 17, 19, 21, 22		500

RS3450A/9	9 Pieces Set/Rail 200mm	(g)
1/4, 5/16, 3/8, 7/16, 1/2, 9/16, 5/8, 11/16, 3/4		360

3450MH (mm)	D (mm)	H ₁ (mm)	H ₂ (mm)	L (mm)	(g)	(pcs.)
8	12	5	17	26	30	10
10	14.5	6	17	26	30	10
12	16.8	7	17	26	29	10
13	18	8	17	26	28	10
14	19.5	8.5	17	27	32	10
17	23.3	9.5	17	29	41	10



3450MH



Nut Grip Socket wrench with additional hexagon drive
Nut Grip Steckschlüssel mit zusätzlichem Aussensechskant
Douilles à deux billes de retenue avec tête hexagonale supplémentaire

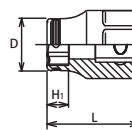

RS3450MH/6	6 Pieces Set/Rail 150mm	(g)
8, 10, 12, 13, 14, 17		230

3425 (E)	D ₁ (mm)	D ₂ (mm)	H (mm)	L (mm)	(g)	(pcs.)
E10(2B)	12	17.3	8.2	26	23	10
E12(2B)	14.5	17.3	9.3	26	25	10
E14(2B)	15.8	17.3	10.6	26	26	10
E16(2B)	18.1	17	11.8	26	27	10
E18(2B)	19.5	18.5	12	32	41	10
E20(2B)	21.9	20	14.4	32	52	10

RS3425/4(2B)	4 Pieces Set/Rail 150mm	(g)
E10, E12, E14, E20		150

RS3450MH/6



Socket Set on Rail
Steckschlüsselsatz auf Schiene
Jeu de douilles sur rail



3425 (2B)



TORX[®] Sockets **Nut Grip**[®]
TORX Steckschlüssel mit 2-facher Kugelhalterung
Douilles Torx à deux billes de retenue

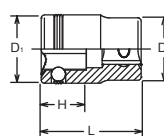

RS3425/4 (2B)



Socket Set on Rail
Steckschlüsselsatz auf Schiene
Jeu de douilles sur rail



3300X / 3300XA

6-point Sockets, Semi-Deep
6-kant Steckschlüssel, mittel-lang
Douilles, semi-profondes 6-pans

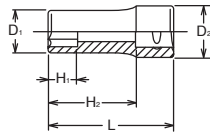

3300X 3305X (mm)	D ₁ (mm)	D ₂ (mm)	H ₁ (mm)	H ₂ (mm)	L (mm)	(g)	(pcs.)
8	12	17.3	9	26.5	40	34	10
9	13	17.3	10	26.5	40	36	10
10	14.5	17.3	11	26.5	40	36	10
11	16	17.2	12	26.5	40	36	10
12	16.8	17.2	13	26.5	40	36	10
13	18	17	14	26.5	40	37	10
14	20	18	16	26.5	40	46	10
15	21	20	16	25.5	40	49	10
16	22	20	17	25.5	40	51	10
17	23.5	22	18	25.5	40	61	10
18	24.5	23	19	24.5	40	68	10
19	25	24	20	24.5	40	75	10

3305X / 3305XA

12-point Sockets, Semi-Deep
12-kant Steckschlüssel, mittel-lang
Douilles, semi-profondes 12-pans

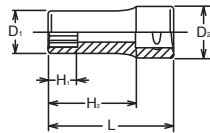

3305XA (inch)	D ₁ (mm)	D ₂ (mm)	H ₁ (mm)	H ₂ (mm)	L (mm)	(g)	(pcs.)
1/4	10.3	17.3	7	26.5	40	32	10
5/16	12	17.3	9	26.5	40	34	10
3/8	13.9	17.3	11	26.5	40	36	10
7/16	16	17.2	12	26.5	40	36	10
1/2	18	17	14	26.5	40	37	10
9/16	20	18.5	16	26.5	40	46	10
5/8	22	20	17	25.5	40	51	10
11/16	24.5	22.5	19	24.5	40	68	10
3/4	25	23.5	20	24.5	40	75	10

RS3300X/8 RS3305X/8

Socket Set on Rail
Steckschlüsselsatz auf Schiene
Jeu de douilles sur rail



RS3300X/8	8 Pieces Set/Rail 200mm	(g)
8, 10, 11, 12, 13, 14, 17, 19		405

RS3305X/8	8 Pieces Set/Rail 200mm	(g)
8, 10, 11, 12, 13, 14, 17, 19		405

RS3300XA/9 RS3305XA/9

Socket Set on Rail
Steckschlüsselsatz auf Schiene
Jeu de douilles sur rail



RS3300XA/9	9 Pieces Set/Rail 200mm	(g)
1/4, 5/16, 3/8, 7/16, 1/2, 9/16, 5/8, 11/16, 3/4		460

RS3305XA/9	9 Pieces Set/Rail 200mm	(g)
1/4, 5/16, 3/8, 7/16, 1/2, 9/16, 5/8, 11/16, 3/4		460

3350X

Nut Grip Socket, Semi-Deep **Nut Grip®**
Steckschlüssel mit 2-facher Kugelhalterung, mittel-lang
Douilles à billes de retenue, semi-profondes

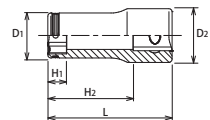

3350X (mm)	D ₁ (mm)	D ₂ (mm)	H ₁ (mm)	H ₂ (mm)	L (mm)	(g)	(pcs.)
8	12	17.4	5	26.5	40	33	10
10	14.5	17.4	6	26.5	40	35	10
12	16.8	17.2	7	26.5	40	40	10
13	18	17	8	26.5	40	45	10
14	19.5	18.5	8.5	26.5	40	48	10

RS3350X/4

Socket Set on Rail
Steckschlüsselsatz auf Schiene
Jeu de douilles sur rail



RS3350X/4	4 Pieces Set/Rail 150mm	(g)
8, 10, 12, 14		165

3/8" Hand Sockets Hand Steckschlüssel Douilles à main

3300M 3305M (mm)	D ₁ (mm)	D ₂ (mm)	H ₁ (mm)	H ₂ (mm)	L (mm)	(g)	(pcs.)
5.5	8.9	17.3	6.5	41.5	55	37	10
6	9.9	17.3	7	41.5	55	37	10
7	10.6	17.3	8	41.5	55	37	10
8	12	17.3	9	41.5	55	40	10
9	13	17.3	10	41.5	55	42	10
10	14.5	17.3	11	41.5	55	46	10
11	16	17.2	12	41.5	55	51	10
12	16.8	17.2	13	41.5	55	52	10
13	18	17	14	41.5	55	53	10
14	20	18	16	41.5	55	60	10
15	21	20	16	40.5	55	74	10
16	22	20	17	40.5	55	76	10
17	23.5	22	18	40.5	55	93	10
18	24.5	23	19	39.5	55	98	10
19	25	24	20	39.5	55	98	10
20	26	25	21	49.5	65	126	10
21	27	26	22	49.5	65	126	10
22	29	28	23	48.5	65	163	10
23	30	29	24	48.5	65	168	10
24	31	30	25	47.5	65	191	10
25	33	30	26	47.5	65	199	10
26	34	31	27	47.5	65	209	10
27	35	32.5	28	47.5	65	218	10

3300M / 3300A

6-point Deep Sockets
6-kant-Steckschlüssel, lang
Douilles longues 6-pans

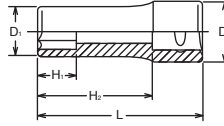

3300A 3305A (inch)	D ₁ (mm)	D ₂ (mm)	H ₁ (mm)	H ₂ (mm)	L (mm)	(g)	(pcs.)
3/16	8.3	17.3	6	41.5	55	35	10
7/32	8.9	17.3	6.5	41.5	55	35	10
1/4	9.9	17.3	7	41.5	55	37	10
5/16	12	17.3	9	41.5	55	40	10
11/32	12.3	17.3	10	41.5	55	41	10
3/8	14	17.3	11	41.5	55	46	10
7/16	16	17.2	12	41.5	55	51	10
1/2	18	17	14	41.5	55	53	10
9/16	20	18	16	41.5	55	60	10
19/32	21	20	16	40.5	55	74	10
5/8	22	20	17	40.5	55	76	10
11/16	23.5	22	18	40.5	55	93	10
3/4	25	24	20	39.5	55	98	10
13/16	27	26	22	49.5	65	126	10
7/8	29	28	23	48.5	65	163	10
15/16	31	30	25	47.5	65	191	10

3305M / 3305A

12-point Deep Sockets
12-kant Steckschlüssel, lang
Douilles longues, 12-pans

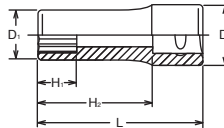

RS3300M/12	12 Pieces Set/Rail 300mm	(g)
8, 9, 10, 11, 12, 13, 14, 15, 16, 17, 18, 19		878

RS3305M/12	12 Pieces Set/Rail 300mm	(g)
8, 9, 10, 11, 12, 13, 14, 15, 16, 17, 18, 19		878

RS3300M/12

Socket Set on Rail
Steckschlüsselsatz auf Schiene
Jeu de douilles sur rail

RS3305M/12



RS3300A/9	9 Pieces Set/Rail 200mm	(g)
1/4, 5/16, 3/8, 7/16, 1/2, 9/16, 5/8, 11/16, 3/4		628

RS3305A/9	9 Pieces Set/Rail 200mm	(g)
1/4, 5/16, 3/8, 7/16, 1/2, 9/16, 5/8, 11/16, 3/4		628

RS3300A/9

Socket Set on Rail
Steckschlüsselsatz auf Schiene
Jeu de douilles sur rail

RS3305A/9



Z-SERIES
HAND
TITANIUM
ACCESSORIES
SCREWDRIVERS
IMPACT
SLEEVE-DRIVE
PROTECTOR
INDUSTRIAL
AUTOMOTIVE
MOTORCYCLE
CONSTRUCTION
SPARE PART

3310M

Surface Drive Deep Sockets
Surface Drive Steckschlüssel, lang
Douilles longues, Surface Drive

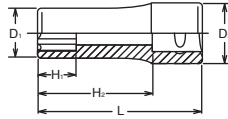

3310M (mm)	D ₁ (mm)	D ₂ (mm)	H ₁ (mm)	H ₂ (mm)	L (mm)	(g)	(pcs.)
6	9.9	17.3	7	41.5	55	37	10
7	10.6	17.3	8	41.5	55	37	10
8	12	17.3	9	41.5	55	40	10
9	13	17.3	10	41.5	55	42	10
10	14.5	17.3	11	41.5	55	46	10
11	16	17.2	12	41.5	55	51	10
12	16.8	17.2	13	41.5	55	52	10
13	18	17	14	41.5	55	53	10
14	20	18	16	41.5	55	60	10
15	21	20	16	40.5	55	74	10
16	22	20	17	40.5	55	76	10
17	23.5	22	18	40.5	55	93	10
18	24.5	23	19	39.5	55	98	10
19	25	24	20	39.5	55	98	10
20	26	25	21	49.5	65	126	10
21	27	26	22	49.5	65	126	10
22	29	28	23	48.5	65	163	10
23	30	29	24	48.5	65	168	10
24	31	30	25	47.5	65	161	10

RS3310M/12

Socket Set on Rail
Steckschlüsselsatz auf Schiene
Jeu de douilles sur rail



RS3310M/12	12 Pieces Set/Rail 300mm	(g)
8, 9, 10, 11, 12, 13, 14, 15, 16, 17, 18, 19		881

3300W

6-point Deep Whitworth Sockets
6-kant Steckschlüssel, lang, Whitworth
Douilles longues à 6-pans Whitworth

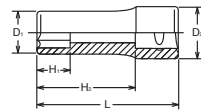

3300W 3305W (W)	D ₁ (mm)	D ₂ (mm)	H ₁ (mm)	H ₂ (mm)	L (mm)	(g)	(pcs.)
1/8	12.3	17.3	10	41.5	55	46	10
3/16	16	17.3	12	41.5	55	55	10
1/4	18	17	14	41.5	55	57	10
5/16	21	20	16	40.5	55	79	10
3/8	24.5	23	19	39.5	55	96	10
7/16	27	26	22	49.5	65	140	10
1/2	30	29	24	48.5	65	193	10
9/16	34	31	27	47.5	65	250	10

3305W

12-point Deep Whitworth Sockets
12-kant Steckschlüssel, Whitworth
Douilles longues à 12-pans Whitworth

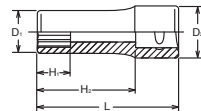

RS3300W/7 RS3305W/7

Socket Set on Rail
Steckschlüsselsatz auf Schiene
Jeu de douilles sur rail



RS3300W/7	7 Pieces Set/Rail 200mm	(g)
1/8, 3/16, 1/4, 5/16, 3/8, 7/16, 1/2		719

RS3305W/7	7 Pieces Set/Rail 200mm	(g)
1/8, 3/16, 1/4, 5/16, 3/8, 7/16, 1/2		719

BS W



BS-W	BS	3/16BS	1/4BS	5/16BS	3/8BS	7/16BS	1/2BS	9/16BS	5/8BS	11/16BS	3/4BS	7/8BS
	W	1/8W	3/16W	1/4W	5/16W	3/8W	7/16W	1/2W	9/16W	5/8W	11/16W	3/4W
S	(ref. mm)	8.64	11.30	13.34	15.24	18.03	20.83	23.37	25.65	27.94	30.48	33.35

3/8"

Hand Sockets
Hand Steckschlüssel
Douilles à main

Z-SERIES
HAND
TITANIUM
ACCESSORIES
SCREWDRIVERS
IMPACT
SLEEVE-DRIVE
PROTECTOR
INDUSTRIAL
AUTOMOTIVE
MOTORCYCLE
CONSTRUCTION
SPARE PART

3325 (E)	D ₁ (mm)	D ₂ (mm)	H ₁ (mm)	H ₂ (mm)	L (mm)	(g)	(pcs.)
E 4	5.6	17.3	4.6	41.5	55	29	10
E 5	6.9	17.3	5.2	41.5	55	31	10
E 6	7.9	17.3	5.4	41.5	55	33	10
E 7	8.9	17.3	6.6	41.5	55	36	10
E 8	9.9	17.3	7	41.5	55	39	10
E10	11.8	17.3	8.2	41.5	55	43	10
E11	13	17.3	8.7	41.5	55	50	10
E12	14.5	17.2	9.3	41.5	55	53	10
E14	15.7	17.2	10.6	41.5	55	57	10
E16	18	17	11.8	41.5	55	69	10

3325 TORX® Deep Sockets
TORX® Steckschlüssel, lang
Douilles longues TORX®

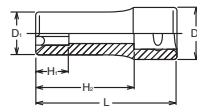

RS3325/9 Socket Set on Rail
Steckschlüsselsatz auf Schiene
Jeu de douilles sur rail



RS3325/9	9 Pieces Set/Rail 200mm	(g)
E4, E5, E6, E7, E8, E10, E12, E14, E16		420

TORX®
(E)

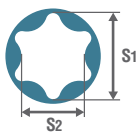

E	E4	E5	E6	E7	E8	E10	E11	E12	E14	E16	E18	E20	E22	E24	E26	E28	E30	E32
S ₁ (ref. mm)	3.7	4.6	5.6	6.1	7.4	9.3	9.9	11.0	12.8	14.6	16.5	18.3	20.1	22.0	23.7	25.5	27.3	29.0
S ₂ (ref. mm)	2.7	3.3	4.0	4.3	5.3	6.8	7.1	7.9	9.2	10.5	11.9	13.2	14.8	15.7	17.5	18.3	20.0	21.3

3350M (mm)	D ₁ (mm)	D ₂ (mm)	H ₁ (mm)	H ₂ (mm)	L (mm)	(g)	(pcs.)
8	12	17.4	5	41.5	55	50	10
10	14.5	17.4	6	41.5	55	54	10
12	16.8	17.2	7	41.5	55	58	10
13	18	17	8	41.5	55	59	10
14	19.5	18.5	8.5	41.5	55	71	10

3350M Nut Grip Deep Sockets **Nut Grip®**
Steckschlüssel mit 2-facher Kugelhalterung, lang
Douilles longues à billes de retenue

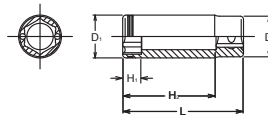

RS3350M/5 Socket Set on Rail
Steckschlüsselsatz auf Schiene
Jeu de douilles sur rail



RS3350M/5	5 Pieces set/Rail 150mm	(g)
8, 10, 12, 13, 14		322



3300FN (mm)	D ₁ (mm)	D ₂ (mm)	H (mm)	L (mm)	S (mm)	(g)	(pcs.)
8	14.5	17.3	6	53	6.4	38	10
9	16	17.3	7	53	6.8	41	10
10	16.8	17.2	7.5	53	7.2	42	10
11	18	17	8.5	53	8.3	42	10
12	20	18	9	53	8.8	50	10
13	21.1	20	9.5	62	9.4	66	10
14	22	20	10.5	62	10.5	66	10
15	23	22	11	70	11.5	82	10
16	24	23	11.5	70	12	90	10
17	25	24	12.5	80	13	110	10
18	27	25	13	80	13.5	120	10
19	28	26	14	80	14.5	130	10
21	30	27.5	15	80	15.5	170	10
22	32	29.5	16	80	16	180	10
24	34.5	31.5	17	80	17	200	10

3300FN Flare Nut Sockets
Geschlitzte Steckschlüssel für Überwurfmuttern
Douilles à tuyauter

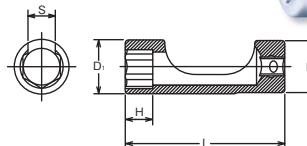

RS3300FN/8 Socket Set on Rail
Steckschlüsselsatz auf Schiene
Jeu de douilles sur rail



RS3300FN/8	8 Pieces Set/Rail 200mm	(g)
9, 10, 11, 13, 14, 16, 17, 19		600

TORX® is a registered trademark of CAMCAR Innovations.
TORX® ist ein registriertes Markenzeichen der Firma CAMCAR Innovations.
TORX® est une marque déposée de CAMCAR Innovations.

3300M (L120)

6-point Extra Deep Sockets
6-kant Steckschlüssel, extra lang
Douilles extra longues 6-pans

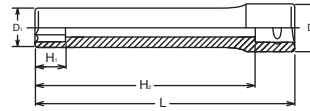
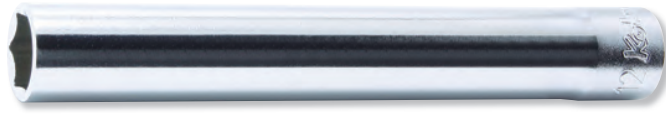

3300M-Size DEEP SOCKET

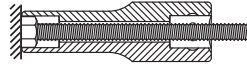

3300M-Size(L120) EXTRA DEEP SOCKET

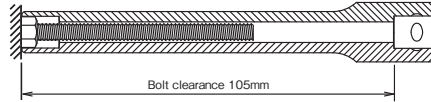

3305M (L120)

12-point Extra Deep Sockets
12-kant Steckschlüssel, extra lang
Douilles extra longues 12-pans

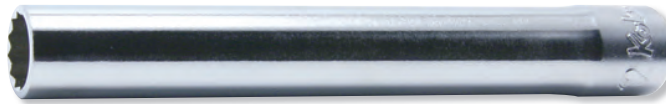

3300M(L120) 3305M(L120) (mm)	D ₁ (mm)	D ₂ (mm)	H ₁ (mm)	H ₂ (mm)	L (mm)	(g)	(pcs.)
8	12	17.3	9	106.5	120	85	10
10	14.5	17.3	11	106.5	120	110	10
12	16.8	17.2	13	106.5	120	116	10
13	18	17	14	106.5	120	155	5
14	20	18	16	106.5	120	166	5

3300M/4-L120 3305M/4-L120

Socket Set
Steckschlüssel Satz
Jeu de clés à douille



3300M/4-L120 4 Pieces Set/△=477g

PLASTIC BAG

Sockets

3300M(L120) 6-point Extra Deep Sockets
8, 10, 12, 14

3305M/4-L120 4 Pieces Set/△=477g

PLASTIC BAG

Sockets

3305M(L120) 12-point Extra Deep Sockets
8, 10, 12, 14

3350M (L120) / 3350A (L120)

Nut Grip Deep Sockets **Nut Grip®**
Steckschlüssel mit 2-facher Kugelhalterung, lang
Douilles extra longues à billes de retenue

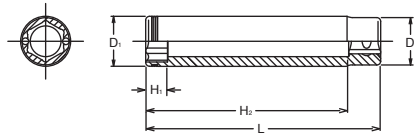

3350M(L120) (mm)	D ₁ (mm)	D ₂ (mm)	H ₁ (mm)	H ₂ (mm)	L (mm)	(g)	(pcs.)
New 8	12	17.3	5	106.5	120	77	10
10	14.5	17.2	6	106.5	120	110	10
12	16.8	17.2	7	106.5	120	116	10

3350A(L120) (inch)	D ₁ (mm)	D ₂ (mm)	H ₁ (mm)	H ₂ (mm)	L (mm)	(g)	(pcs.)
New 7/16	15.8	17.3	6.5	106.5	120	123	10
New 1/2	18	17	8	106.5	120	142	10
New 9/16	20	18.5	8.5	106.5	120	179	10



NUT GRIP®

3350M/2-L120

Socket Set
Steckschlüssel Satz
Jeu de clés à douille



3350M/2-L120 2 Pieces Set/△=230g

PLASTIC BAG

Sockets

3350M(L120) Nut Grip Extra Deep Sockets
10, 12

3440M 3445M (mm)	D ₁ (mm)	D ₂ (mm)	H (mm)	L (mm)	(g)	(pcs.)
8	12	19	7.3	47	50	10
9	13.3	19	7.8	47.5	50	10
10	14.5	19	8.8	48.5	64	10
11	15.8	19	9.8	49.5	66	10
12	17	19	10.3	50	67	10
13	18.3	19	11.3	51	68	10
14	19.5	19	11.3	51	69	10
15	20.8	19	12.8	53.5	70	10
16	22	19	12.8	53.5	77	10
17	23.3	19	13.8	54.5	80	10
18	24.5	19	13.8	54.5	80	10
19	25.8	19	15.8	56.5	84	10
21	28.3	19	16.8	56.5	96	10

3440A 3445A (inch)	D ₁ (mm)	D ₂ (mm)	H (mm)	L (mm)	(g)	(pcs.)
5/16	12	19	7.3	47	50	10
3/8	14	19	8.3	48	64	10
7/16	15.8	19	9.8	49.5	66	10
1/2	18.3	19	11.3	51	68	10
9/16	19.5	19	11.3	51	69	10
5/8	22	19	12.8	53.5	77	10
11/16	24.5	19	13.8	54.5	80	10
3/4	25.8	19	15.8	56.5	84	10

RS3440M/8	8 Pieces Set/Rail 200mm	(g)
8, 10, 11, 12, 13, 14, 17, 19		550

RS3440A/8	8 Pieces Set/Rail 200mm	(g)
5/16, 3/8, 7/16, 1/2, 9/16, 5/8, 11/16, 3/4		570

3445W (W)	D ₁ (mm)	D ₂ (mm)	H (mm)	L (mm)	(g)	(pcs.)
1/8	13.3	19	7.8	47.5	50	10
3/16	15.8	19	9.7	49.5	66	10
1/4	18.3	19	11.3	51	68	10
5/16	20.8	19	12.8	53.5	70	10
3/8	24.5	19	13.8	54.5	80	10
7/16	28.3	19	16.8	57.5	96	10
1/2	30.8	19	17.8	58.5	105	10

RS3445W/7	7 Pieces Set/Rail 200mm	(g)
1/8, 3/16, 1/4, 5/16, 3/8, 7/16, 1/2		570

3440T (E)	D ₁ (mm)	D ₂ (mm)	H (mm)	L (mm)	(g)	(pcs.)
E 6	7.9	19	5.4	44.9	60	10
E 8	9.9	19	7	46.5	63	10
E10	11.8	19	8.2	47.7	63	10
E12	14.5	19	9.3	48.8	68	10
E14	15.7	19	10.6	50.1	68	10
E16	18	19	11.8	51.3	70	10
E18	19.5	19	13	53.5	78	10
E20	22	19	14.4	54.9	81	10

3440M / 3440A

6-point Universal Sockets
6-kant Gelenk-Einsätze
Douilles articulées, 6-pans

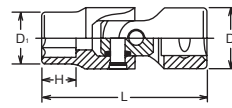

3445M / 3445A

12-point Universal Sockets
12-kant Gelenk-Einsätze
Douilles articulées, 12-pans

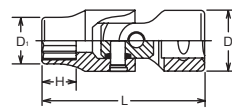

RS3440M/8 RS3440A/8

Socket Set on Rail
Steckschlüsselsatz auf Schiene
Jeu de douilles sur rail



3445W

12-Point Whitworth Universal Socket
12-kant Gelenk-Einsatz, Whitworth
Douille articulées, 12-pans, Whitworth

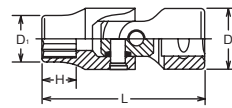

RS3445W/7

Socket Set on Rail
Steckschlüsselsatz auf Schiene
Jeu de douilles sur rail



3440T

TORX® Universal Sockets
TORX® Gelenk-Einsätze
Douilles articulées TORX®

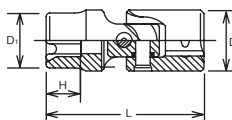

RS3440T/8



RS3440T/8	8 Pieces Set/Rail 200mm	(g)
E6, E8, E10, E12, E14, E16, E18, E20		594

TORX®
(E)

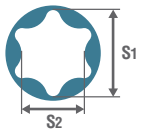

E	E4	E5	E6	E7	E8	E10	E11	E12	E14	E16	E18	E20	E22	E24	E26	E28	E30	E32
S ₁ (ref. mm)	3.7	4.6	5.6	6.1	7.4	9.3	9.9	11.0	12.8	14.6	16.5	18.3	20.1	22.0	23.7	25.5	27.3	29.0
S ₂ (ref. mm)	2.7	3.3	4.0	4.3	5.3	6.8	7.1	7.9	9.2	10.5	11.9	13.2	14.8	15.7	17.5	18.3	20.0	21.3

3441M

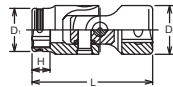

3441M (mm)	D ₁ (mm)	D ₂ (mm)	H (mm)	L (mm)	(g)	(pcs.)
8	12	19	5	46	57	10
10	14.5	19	6	46	58	10
11	15.8	19	6.5	46.5	61	10
12	16.8	19	7	47	58	10
13	18	19	8	48	60	10
14	19.5	19	8.5	49.5	65	10
15	21	19	9	50	69	10
16	22	19	9	50	70	10
17	23.5	19	9.5	51	73	10
18	24.6	19	10.5	51.5	76	10
19	26	19	11.5	52.5	80	10



RS3441M/11



RS3441M/11	11 Pieces Set/Rail 300mm	(g)
8, 10, 11, 12, 13, 14, 15, 16, 17, 18, 19		750

3340M-75

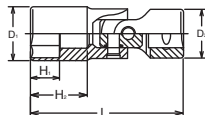

3340M-75 (mm)	D ₁ (mm)	D ₂ (mm)	H ₁ (mm)	H ₂ (mm)	L (mm)	(g)	(pcs.)
8	12	19	9	39	75	82	10
10	14.5	19	11	39	75	87	10
11	15.8	19	12	39	75	87	10
12	17	19	13	39	75	92	10
13	18.3	19	14	36	75	93	10
14	19.5	19	15	35	75	103	10
15	20.8	19	16	35	75	104	10
16	22	19	17	34	75	110	10
17	23.3	19	18	34	75	115	10
18	24.5	19	19	34	75	119	10
19	25.8	19	20	33	75	123	10

RS3340M/8-L75



RS3340M/8-L75	8 Pieces Set/Rail 200mm	(g)
8, 10, 11, 12, 13, 14, 17, 19		810

3/8" Hand Sockets Hand Steckschlüssel Douilles à main

3430M (mm)	D (mm)	H (mm)	L (mm)	⚖️ (g)	📦 (pcs.)
5	19	15.5	62	66	10
6	19	15.5	62	70	10
7	19	15.5	62	72	10
8	19	15.5	62	74	10
10	19	15.5	62	78	10
12	19	15.5	62	85	10

3430M  Universal Hex Sockets
Gelenk-Einsätze für Schrauben mit Innensechskant
Douilles articulées, 6-pans mâle

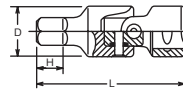

RS3430M/6	6 Pieces Set/Rail 150mm	⚖️ (g)
5, 6, 7, 8, 10, 12		470

RS3430M/6   Socket Set on Rail
Steckschlüsselsatz auf Schiene
Jeu de douilles sur rail

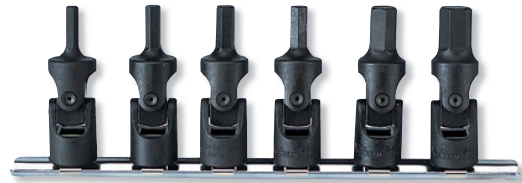

3117M-125 / -250  Extended Sockets
Schäftsteckschlüssel
Douilles rallongées

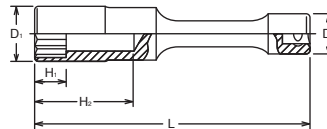

3117M-125 (mm)	D ₁ (mm)	D ₂ (mm)	H ₁ (mm)	H ₂ (mm)	L (mm)	⚖️ (g)	📦 (pce.)
10	14.5	18	10	44	125	121	1
11	16	18	11	44	125	133	1
12	17	18	12	44	125	133	1
13	18	18	13	44	125	134	1
14	19.5	18	14	44	125	145	1
17	23.5	18	17	44	125	178	1
19	25	18	19	44	125	187	1
21	27	18	21	44	125	195	1
22	29	18	22	44	125	214	1

3117M-250 (mm)	D ₁ (mm)	D ₂ (mm)	H ₁ (mm)	H ₂ (mm)	L (mm)	⚖️ (g)	📦 (pce.)
10	14.5	18	10	44	250	233	1
11	16	18	11	44	250	241	1
12	17	18	12	44	250	246	1
13	18	18	13	44	250	249	1
14	19.5	18	14	44	250	262	1
17	23.5	18	17	44	250	289	1
19	25	18	19	44	250	298	1
21	27	18	21	44	250	302	1
22	29	18	22	44	250	325	1

Z-SERIES

HAND

TITANIUM

ACCESSORIES

SCREWDRIVERS

IMPACT

SLEEVE-DRIVE

PROTECTOR

INDUSTRIAL

AUTOMOTIVE

MOTORCYCLE



CONSTRUCTION

SPARE PART

3000-60 (PH)

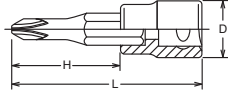
 PH Bit Sockets
Steckschlüssel für Kreuzschlitzschrauben, PH
Douilles tournevis pour vis à empreinte PH





3000 (PH)	D (mm)	H (mm)	L (mm)	 (g)	 (pcs.)
1	18	33.5	60	49	10
2	18	33.5	60	49	10
3	18	33.5	60	49	10
4	18	33.5	60	50	10

3000-50 (PZ)

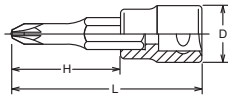
 PZ Bit Sockets
Steckschlüssel für Kreuzschlitzschrauben, PZ
Douilles tournevis pour vis à empreinte PZ









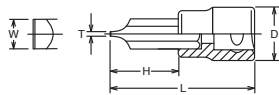









3000-50 (PZ)	D (mm)	H (mm)	L (mm)	 (g)	 (pcs.)
PZ1	18	23.5	50	50	10
PZ2	18	23.5	50	50	10
PZ3	18	23.5	50	50	10

3005-60

 Bit Sockets for Slotted Heads
Steckschlüssel für Schlitzschrauben
Douilles tournevis pour vis à fente





3005	TxW (mm)	D (mm)	H (mm)	L (mm)	 (g)	 (pcs.)
5	1.0x 5.5	18	33.5	60	47	10
8	1.2x 8	18	33.5	60	49	10
10	1.6x10	20	33.5	60	85	10

	 PH	 PZ	 Slotted	 HEX	 HEX (ball point)	 Triple Square (XZN)	 TORX® (T)	 TORX® (TH)	 TORXPLUS® (IP)	 TORXPLUS® (IPR)	 Ribe-CV
 1/4"	No.2000 series	No.2000(PZ) series	No.2005 series	No.2010M/A series	No.2011M series	No.2020 series	No.2025 series	No.2025(TH) series	No.2025(IP) series	No.2025(IPR) series	—
 3/8"	No.3000 series	No.3000(PZ) series	No.3005 series	No.3010M/A No.3012M/A No.3015M series	No.3011M series	No.3020 series	No.3025 series	No.3025(TH) series	No.3025(IP) series	No.3025(IPR) series	No.3027 series
 1/2"	No.4000 series	No.4000(PZ) series	No.4005 series	No.4010M/A No.4012M/A series	—	No.4020 series	No.4025 series	—	No.4025(IP) series	—	No.4027 series

3/8"

Hand Sockets
Hand Steckschlüssel
Douilles à main

3010M-38 / -62 / -100 / -160 3010A-50

 Inhex Bit Sockets
Steckschlüssel für Innensechskant-Schrauben
 Douilles tournevis pour vis 6-pans creux

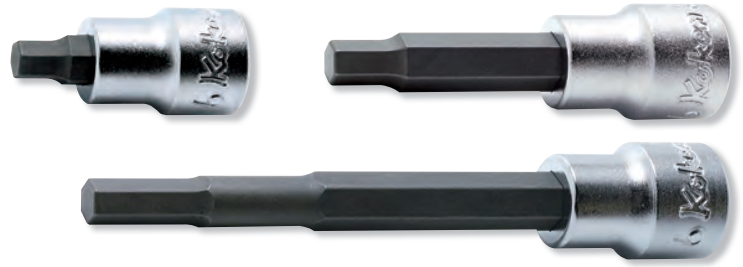
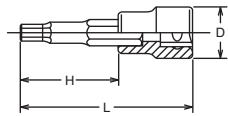

3010M-38 (mm)	D (mm)	H (mm)	L (mm)	(g)	(pcs.)
3	18	11.5	38	27	10
4	18	11.5	38	28	10
5	18	11.5	38	30	10
6	18	11.5	38	31	10
7	18	11.5	38	32	10
8	18	11.5	38	33	10
9	20	11.5	38	47	10
10	20	11.5	38	48	10
11	20	11.5	38	59	10
12	20	11.5	38	60	10
13	22	11.5	38	76	5
14	22	11.5	38	78	5



3010M-100 (mm)	D (mm)	H (mm)	L (mm)	(g)	(pcs.)
3	18	73.5	100	58	10
4	18	73.5	100	60	10
5	18	73.5	100	63	10
6	18	73.5	100	64	10
7	18	73.5	100	66	10
8	18	73.5	100	69	10
9	20	73.5	100	100	10
10	20	73.5	100	102	10
11	20	73.5	100	129	10
12	20	73.5	100	131	10
13	22	73.5	100	158	5
14	22	73.5	100	160	5

3010M-62 (mm)	D (mm)	H (mm)	L (mm)	(g)	(pcs.)
3	18	35.5	62	43	10
4	18	35.5	62	45	10
5	18	35.5	62	48	10
6	18	35.5	62	49	10
7	18	35.5	62	50	10
8	18	35.5	62	62	10
9	20	35.5	62	75	10
10	20	35.5	62	76	10
11	20	35.5	62	92	10
12	20	35.5	62	94	10
13	22	35.5	62	107	5
14	22	35.5	62	109	5

3010M-160 (mm)	D (mm)	H (mm)	L (mm)	(g)	(pcs.)
3	18	133.5	160	84	10
4	18	133.5	160	86	10
5	18	133.5	160	89	10
6	18	133.5	160	90	10
7	18	133.5	160	92	10
8	18	133.5	160	95	10
9	20	133.5	160	125	10
10	20	133.5	160	128	10
11	20	133.5	160	153	10
12	20	133.5	160	157	10
13	22	133.5	160	237	5
14	22	133.5	160	239	5

3010A-50 (inch)	D (mm)	H (mm)	L (mm)	(g)	(pcs.)
1/8	18	23.5	50	35	10
5/32	18	23.5	50	36	10
3/16	18	23.5	50	36	10
7/32	18	23.5	50	38	10
1/4	18	23.5	50	40	10
9/32	18	23.5	50	42	10
5/16	18	23.5	50	44	10
11/32	20	23.5	50	59	10
3/8	20	23.5	50	60	10
7/16	20	23.5	50	74	10
1/2	22	23.5	50	91	5

RS3010M/8-L38	8 Pieces Set/Rail 200mm	(g)
3, 4, 5, 6, 7, 8, 10, 12	322	
RS3010M/8-L62	8 Pieces Set/Rail 200mm	(g)
3, 4, 5, 6, 7, 8, 10, 12	490	
RS3010M/8-L100	8 Pieces Set/Rail 200mm	(g)
3, 4, 5, 6, 7, 8, 10, 12	645	
RS3010A/8-L50	8 Pieces Set/Rail 200mm	(g)
1/8, 5/32, 3/16, 7/32, 1/4, 5/16, 3/8, 1/2	400	

RS3010M/8-L38  Socket Set on Rail
RS3010M/8-L62  Steckschlüsselsatz auf Schiene
RS3010M/8-L100  Jeu de douilles sur rail
RS3010A/8-L50 



Z-SERIES
HAND
TITANIUM
ACCESSORIES
SCREWDRIVERS
IMPACT
SLEEVE-DRIVE
PROTECTOR
INDUSTRIAL
AUTOMOTIVE
MOTORCYCLE
CONSTRUCTION
SPARE PART

Hand Sockets
Hand Steckschlüssel
Douilles à main

3/8"

3012M-25

Inhex Sockets
Steckschlüssel für Innensechskant-Schrauben
Douilles tournevis pour vis 6-pans creux

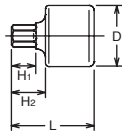

3012M-25 (mm)	D (mm)	H ₁ (mm)	H ₂ (mm)	L (mm)	(g)	(pcs.)
3	18.5	5.5	10	25	22	10
4	18.5	5.5	10	25	22	10
5	18.5	6.5	10	25	22	10
6	18.5	7.5	10	25	23	10
7	18.5	10	-	25	24	10
8	18.5	10	-	25	25	10
10	18.5	10	-	25	27	10
12	18.5	10	-	25	30	10
14	19	10	-	25	30	10
17	19	10	-	25	30	10

3012M-52 / -62 / -75 3012A-52 / -62 / -75

Inhex Sockets
Steckschlüssel für Innensechskant-Schrauben
Douilles tournevis pour vis 6-pans creux



For Lubrication Service
Schmierdienst-Werkzeuge
Service lubrification-vidange

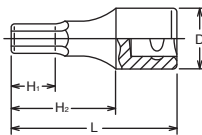

3012M/A are for hand use only.
Do not use with a power or impact wrench.
Bitte nicht auf Schlagschrauber oder anderen
Maschinen gebrauchen.
À ne pas utiliser sur des machines

3012M-52 (mm)	D (mm)	H ₁ (mm)	H ₂ (mm)	L (mm)	(g)	(pcs.)
3	18	10	34	52	35	10
4	18	15.5	34	52	38	10
5	18	15.5	34	52	40	10
6	18	15.5	34	52	42	10
7	18	15.5	34	52	46	10
8	18.5	15.5	34	52	50	10
9	18.5	15.5	34	52	55	10
10	20	15.5	34	52	66	10
11	20	15.5	34	52	72	10
12	20	15.5	34	52	77	10
13	20	15.5	34	52	82	10
14	20	15.5	34	52	89	10

3012A-52 (inch)	D (mm)	H ₁ (mm)	H ₂ (mm)	L (mm)	(g)	(pcs.)
1/8	18	10	34	52	35	10
5/32	18	15.5	34	52	38	10
3/16	18	15.5	34	52	40	10
7/32	18	15.5	34	52	42	10
1/4	18	15.5	34	52	44	10
9/32	18	15.5	34	52	46	10
5/16	18.5	15.5	34	52	50	10
11/32	18.5	15.5	34	52	55	10
3/8	20	15.5	34	52	65	10
7/16	20	15.5	34	52	72	10
1/2	20	15.5	34	52	82	10
9/16	20	15.5	34	52	89	10

3012M-62 (mm)	D (mm)	H ₁ (mm)	H ₂ (mm)	L (mm)	(g)	(pcs.)
3	18	10	44	62	38	10
4	18	15.5	44	62	40	10
5	18	15.5	44	62	43	10
6	18	15.5	44	62	46	10
7	18	15.5	44	62	53	10
8	18.5	15.5	44	62	58	10
9	18.5	15.5	44	62	63	10
10	20	15.5	44	62	77	10
11	20	15.5	44	62	83	10
12	20	15.5	44	62	90	10
13	20	15.5	44	62	95	10
14	20	15.5	44	62	109	10

3012A-62 (inch)	D (mm)	H ₁ (mm)	H ₂ (mm)	L (mm)	(g)	(pcs.)
1/8	18	10	44	62	38	10
5/32	18	15.5	44	62	40	10
3/16	18	15.5	44	62	43	10
7/32	18	15.5	44	62	46	10
1/4	18	15.5	44	62	48	10
9/32	18	15.5	44	62	53	10
5/16	18.5	15.5	44	62	58	10
11/32	18.5	15.5	44	62	63	10
3/8	20	15.5	44	62	73	10
7/16	20	15.5	44	62	83	10
1/2	20	15.5	44	62	95	10
9/16	20	15.5	44	62	109	10

3012M-75 (mm)	D (mm)	H ₁ (mm)	H ₂ (mm)	L (mm)	(g)	(pcs.)
3	18	10	57	75	41	10
4	18	15.5	57	75	43	10
5	18	15.5	57	75	48	10
6	18	15.5	57	75	53	10
7	18	15.5	57	75	58	10
8	18.5	15.5	57	75	72	10
9	18.5	15.5	57	75	92	10
10	20	15.5	57	75	114	10
11	20	15.5	57	75	120	10
12	20	15.5	57	75	127	10
13	20	15.5	57	75	132	10
14	20	15.5	57	75	146	10

3012A-75 (inch)	D (mm)	H ₁ (mm)	H ₂ (mm)	L (mm)	(g)	(pcs.)
1/8	18	10	57	75	41	10
5/32	18	15.5	57	75	43	10
3/16	18	15.5	57	75	48	10
7/32	18	15.5	57	75	53	10
1/4	18	15.5	57	75	53	10
9/32	18	15.5	57	75	58	10
5/16	18.5	15.5	57	75	72	10
11/32	18.5	15.5	57	75	92	10
3/8	20	15.5	57	75	110	10
7/16	20	15.5	57	75	120	10
1/2	20	15.5	57	75	132	10
9/16	20	15.5	57	75	146	10

RS3012M/8-L52 RS3012A /8-L52

Socket Set on Rail
Steckschlüsselsatz auf Schiene
Jeu de douilles sur rail



RS3012M/8-L52	8 Pieces Set/Rail 200mm	(g)
3, 4, 5, 6, 7, 8, 10, 12		394

RS3012A/8-L52	8 Pieces Set/Rail 200mm	(g)
1/8, 5/32, 3/16, 7/32, 1/4, 5/16, 3/8, 1/2		425

3011M-62 (mm)	D (mm)	H (mm)	L (mm)	(g)	(pcs.)
3	18	35.5	62	45	10
4	18	35.5	62	46	10
5	18	35.5	62	48	10
6	18	35.5	62	49	10
7	18	35.5	62	50	10
8	18	35.5	62	51	10
10	20	35.5	62	66	10
12	20	35.5	62	79	10

3011M-100 (mm)	D (mm)	H (mm)	L (mm)	(g)	(pcs.)
3	18	73.5	100	61	10
4	18	73.5	100	62	10
5	18	73.5	100	64	10
6	18	73.5	100	65	10
7	18	73.5	100	67	10
8	18	73.5	100	68	10
10	20	73.5	100	91	10

3011M-120 (mm)	D (mm)	H (mm)	L (mm)	(g)	(pcs.)
3	18	93.5	120	77	10
4	18	93.5	120	78	10
5	18	93.5	120	80	10
6	18	93.5	120	81	10
7	18	93.5	120	83	10
8	18	93.5	120	84	10

3011M-160 (mm)	D (mm)	H (mm)	L (mm)	(g)	(pcs.)
3	18	133.5	160	87	10
4	18	133.5	160	88	10
5	18	133.5	160	89	10
6	18	133.5	160	91	10
7	18	133.5	160	93	10
8	18	133.5	160	95	10

3015M-62 (mm)	D (mm)	H (mm)	L (mm)	(g)	(pcs.)
3	18	35.5	62	43	10
4	18	35.5	62	45	10
5	18	35.5	62	50	10
6	18	35.5	62	50	10
7	18	35.5	62	50	10
8	18	35.5	62	62	10
10	20	35.5	62	75	10
12	20	35.5	62	95	10

3015M-100 (mm)	D (mm)	H (mm)	L (mm)	(g)	(pcs.)
3	18	73.5	100	60	10
4	18	73.5	100	60	10
5	18	73.5	100	65	10
6	18	73.5	100	65	10
7	18	73.5	100	70	10
8	18	73.5	100	70	10
10	20	73.5	100	105	10
12	20	73.5	100	135	10

RS3015M/8-L62	8 Pieces Set/Rail 200mm	(g)
3, 4, 5, 6, 7, 8, 10, 12		500

RS3015M/8-L100	8 Pieces Set/Rail 200mm	(g)
3, 4, 5, 6, 7, 8, 10, 12		650

3011M-62 / -100 / -120 / -160

Ballpoint Inhex Sockets
Steckschlüssel mit Kugelkopf, für Innensechskant-Schrauben
Douilles tournevis avec tête sphérique pour vis 6-pans creux

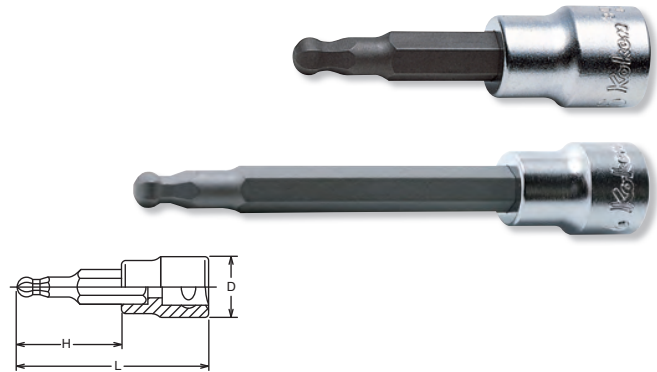

Ballpoint bit sockets have less strength due to the special design. Make sure to use them correctly.
Kugelkopf-Biteinsätze haben aufgrund der speziellen Form eine geringere Festigkeit. Achten Sie darauf, diese richtig zu verwenden.
Les douilles à tête sphérique sont moins résistantes en raison de leur conception spéciale. Veuillez les utiliser correctement.

3015M-62 / -100

Inhex Bit Socket, **Grip Ring**
Steckschlüssel für Innensechskant-Schrauben
Douilles tournevis pour vis 6-pans creux



Grip Ring holds hex screws

Grip Ring bit sockets have less strength due to the special design. Make sure to use them correctly.
Grip Ring Bit-Einsätze haben aufgrund ihrer speziellen Konstruktion eine geringere Festigkeit. Achten Sie darauf, diese richtig zu verwenden.
Les douilles avec bague de préhension sont moins résistantes en raison de leur conception spéciale. Veuillez les utiliser correctement.

RS3015M/8-L62 Socket Set on Rail
RS3015M/8-L100 Steckschlüsselsatz auf Schiene
Jeu de douilles sur rail



3020-38 / -50 / -100 / -120



XZN Bit Sockets
Steckschlüssel für XZN Schrauben
Douilles tournevis pour empreinte XZN

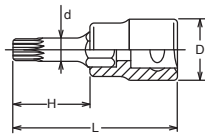

3020-38 (XZN)	D (mm)	d (mm)	H (mm)	L (mm)	(g)	(pcs.)
M 5	18	7.8	11.5	38	32	10
M 6	18	7.8	11.5	38	33	10
M 8	18	7.8	11.5	38	36	10
M10	20	11.9	11.5	38	51	10
M12	20	11.9	11.5	38	52	10
M14	22	13.9	11.5	38	74	10

3020-50 (XZN)	D (mm)	d (mm)	H (mm)	L (mm)	(g)	(pcs.)
M 4	18	7.8	23.5	50	35	10
M 5	18	7.8	23.5	50	37	10
M 6	18	7.8	23.5	50	39	10
M 8	18	7.8	23.5	50	40	10
M10	20	11.9	23.5	50	65	10
M12	20	11.9	23.5	50	69	10
M14	22	13.9	23.5	50	75	10

3020-100 (XZN)	D (mm)	d (mm)	H (mm)	L (mm)	(g)	(pcs.)
M 4	18	7.8	73.5	100	57	10
M 5	18	7.8	73.5	100	59	10
M 6	18	7.8	73.5	100	61	10
M 8	18	7.8	73.5	100	62	10
M10	20	11.9	73.5	100	99	10
M12	20	11.9	73.5	100	103	10
M14	22	13.9	73.5	100	145	5

3020-120 (XZN)	D (mm)	d (mm)	H (mm)	L (mm)	(g)	(pcs.)
M 4	18	7.8	93.5	120	77	10
M 5	18	7.8	93.5	120	79	10
M 6	18	7.8	93.5	120	81	10
M 8	18	7.8	93.5	120	82	10
M10	20	11.9	93.5	120	119	10
M12	20	11.9	93.5	120	123	10
M14	22	13.9	93.5	120	165	5

RS3020/6-L38



Socket Set on Rail
Steckschlüsselsatz auf Schiene
Jeu de douilles sur rail



RS3020/6-L38	6 Pieces Set/Rail 150mm	(g)
M5, M6, M8, M10, M12, M14		308

RS3020/7-L50



Socket Set on Rail
Steckschlüsselsatz auf Schiene
Jeu de douilles sur rail



RS3020/7-L50	7 Pieces Set/Rail 200mm	(g)
M4, M5, M6, M8, M10, M12, M14		400

XZN

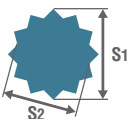

XZN		M4	M5	M6	M8	M10	M12	M14	M16	M18
S ₁	(ref. mm)	3.6	4.8	6.1	7.3	9.7	11.5	13.3	15.7	16.9
S ₂	(ref. mm)	3.1	4.1	5.1	6.1	8.1	9.7	11.2	13.2	14.2

3/8"

Hand Sockets
Hand Steckschlüssel
Douilles à main

3025-38 (T)	D (mm)	H (mm)	L (mm)	(g)	(pcs.)
T 8	18	11.5	38	32	10
T 9	18	11.5	38	32	10
T10	18	11.5	38	32	10
T15	18	11.5	38	33	10
T20	18	11.5	38	33	10
T25	18	11.5	38	33	10
T27	18	11.5	38	33	10
T30	18	11.5	38	33	10
T40	18	11.5	38	34	10
T45	18	11.5	38	37	10
T50	18	11.5	38	49	10
T55	20	11.5	38	57	10

3025-50 (T)	D (mm)	H (mm)	L (mm)	(g)	(pcs.)
T 8	18	23.5	50	36	10
T 9	18	23.5	50	36	10
T10	18	23.5	50	36	10
T15	18	23.5	50	36	10
T20	18	23.5	50	36	10
T25	18	23.5	50	37	10
T27	18	23.5	50	37	10
T30	18	23.5	50	38	10
T40	18	23.5	50	39	10
T45	18	23.5	50	41	10
T50	18	23.5	50	55	10
T55	20	23.5	50	67	10

RS3025/8-L38	8 Pieces Set/Rail 200mm	(g)
T10, T15, T20, T25, T27, T30, T40, T45		300

RS3025/8-L50	8 Pieces Set/Rail 200mm	(g)
T10, T15, T20, T25, T27, T30, T40, T45		320

RS3025/8-L140KE	8 Pieces Set/Rail 200mm	(g)
T20, T25, T27, T30, T40, T45, T50, T55		700

3025-38 / -50 / -140 (T)



TORX® Bit Sockets
TORX® Bit-Steckschlüssel
Douilles tournevis, TORX®

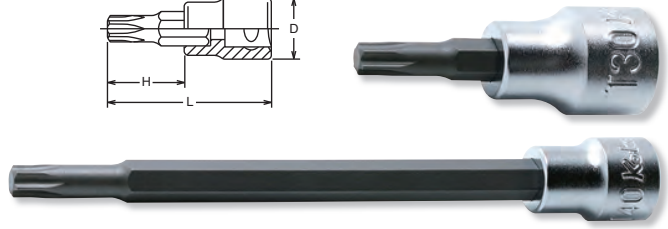
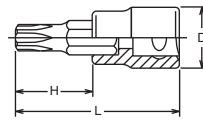

3025-140 (T)	D (mm)	H (mm)	L (mm)	(g)	(pcs.)
T 9	18	113.5	140	75	10
T10	18	113.5	140	75	10
T15	18	113.5	140	75	10
T20	18	113.5	140	75	10
T25	18	113.5	140	76	10
T27	18	113.5	140	76	10
T30	18	113.5	140	77	10
T40	18	113.5	140	78	10
T45	18	113.5	140	80	10
T50	20	113.5	140	94	10
T55	20	113.5	140	106	10

RS3025/8-L38



Socket Set on Rail
Steckschlüsselsatz auf Schiene
Jeu de douilles sur rail

RS3025/8-L50



RS3025/8-L140KE



TORX®
(T)

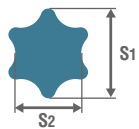

T	T8	T9	T10	T15	T20	T25	T27	T30	T40	T45	T50	T55	T60	T70	T80	T90	T100
S ₁ (ref. mm)	2.3	2.5	2.7	3.3	3.9	4.5	5.0	5.6	6.7	7.9	8.9	11.3	13.3	15.6	17.6	20.0	22.2
S ₂ (ref. mm)	1.7	1.8	2.0	2.3	2.8	3.2	3.6	4.0	4.8	5.6	6.2	8.0	9.5	11.1	12.7	14.2	15.8

3025-50	D (mm)	H (mm)	L (mm)	(g)	(pcs.)
T35	18	23.5	50	39	10

3025-100R (T)	D (mm)	d (mm)	H (mm)	L (mm)	(g)	(pcs.)
T20	18	4	73.5	100	38	10
T25	18	4.6	73.5	100	40	10
T27	18	5.2	73.5	100	42	10
T30	18	5.7	73.5	100	45	10
T40	18	6.8	73.5	100	52	10
T45	18	8	73.5	100	73	10
T50	20	9	73.5	100	80	10
T55	20	11.4	73.5	100	106	10

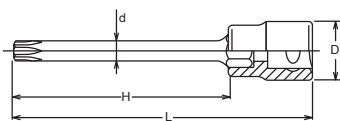

3025-50-T35



Bit Socket
Bit-Steckschlüssel
Douilles tournevis



3025-100R (T)



TORX® Bit Sockets, round-shaft
TORX® Bit-Steckschlüssel mit Rundschaft
Douilles tournevis TORX® avec manche ronde



RS3025/8-L100R



Socket Set on Rail
Steckschlüsselsatz auf Schiene
Jeu de douilles sur rail



RS3025/8-L100R	8 Pieces Set/Rail 200mm	(g)
T20, T25, T27, T30, T40, T45, T50, T55		490

TORX® is a registered trademark of CAMCAR Innovations.
TORX® ist ein registriertes Markenzeichen der Firma CAMCAR Innovations.
TORX® est une marque déposée de CAMCAR Innovations.

3025-50 / -160 (TH)

 Tamper Resistant TORX® Bit Sockets
Tamper Resistant TORX® Bit-Steckschlüssel
Douilles tournevis, Tamper-Resistant TORX®



 Tamper Resistant TORX® Bit Sockets have less strength due to special design. Make sure to use it correctly.

Bitte beachten Sie die geringere Belastbarkeit der Tamper Resistant Torx Steckschlüssel.

Veuillez respecter la moindre capacité inférieure de charge des douilles Tamper Resistant Torx

3025-50 (TH)	D (mm)	H (mm)	L (mm)	(g)	(pcs.)
T10H	18	23.5	50	37	10
T15H	18	23.5	50	38	10
T20H	18	23.5	50	38	10
T25H	18	23.5	50	38	10
T27H	18	23.5	50	38	10
T30H	18	23.5	50	39	10
T40H	18	23.5	50	40	10
T45H	18	23.5	50	41	10
T50H	18	23.5	50	61	10
T55H	20	23.5	50	61	10

3025-160 (TH)	D (mm)	H (mm)	L (mm)	(g)	(pcs.)
T25H	18	133.5	160	83	10
T27H	18	133.5	160	83	10
T30H	18	133.5	160	84	10
T40H	18	133.5	160	85	10
T45H	18	133.5	160	86	10
T50H	20	133.5	160	128	10
T55H	20	133.5	160	128	10

RS3025/9-HOLE



 Socket Set on Rail
Steckschlüsselsatz auf Schiene
Jeu de douilles sur rail



RS3025/9-HOLE	9 Pieces Set/Rail 200mm	(g)
T10H, T15H, T20H, T25H, T27H, T30H, T40H, T45H, T50H		405

3247



Bit Socket Set
Schraubendreher-Steckschlüssel Satz
Jeu de douilles de vissage



3247	4 Pieces Set/ =385g
------	---------------------

PLASTIC BAG

Sockets

 3025.160 Tamper-Resistant TORX® Bit Sockets
T27H, T30H, T40H, T50H

3025-100R (TH)



Tamper-Resistant TORX® Bit Sockets, round-shaft
Tamper-Resistant TORX® Bit-Steckschlüssel mit Rundschaft
Douilles tournevis, Tamper-Resistant TORX® avec manche ronde

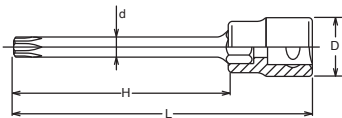

3025-100R (TH)	D (mm)	d (mm)	H (mm)	L (mm)	(g)	(pcs.)
T20H	18	4	73.5	100	38	10
T25H	18	4.6	73.5	100	40	10
T27H	18	5.2	73.5	100	42	10
T30H	18	5.7	73.5	100	45	10
T40H	18	6.8	73.5	100	52	10
T45H	18	8	73.5	100	73	10
T50H	20	9	73.5	100	80	10
T55H	20	11.4	73.5	100	106	10

RS3025/8-L100RH



 Socket Set on Rail
Steckschlüsselsatz auf Schiene
Jeu de douilles sur rail



RS3025/8-L100RH	8 Pieces Set/Rail 200mm	(g)
T20H, T25H, T27H, T30H, T40H, T45H, T50H, T55H		490

3/8"

Hand Sockets
Hand Steckschlüssel
Douilles à main

3025-50 (IP)	D (mm)	H (mm)	L (mm)	(g)	(pcs.)
10IP	18	23.5	50	38	10
15IP	18	23.5	50	38	10
20IP	18	23.5	50	38	10
25IP	18	23.5	50	38	10
27IP	18	23.5	50	40	10
30IP	18	23.5	50	40	10
40IP	18	23.5	50	41	10
45IP	18	23.5	50	41	10
50IP	20	23.5	50	61	10
55IP	20	23.5	50	61	10

3025-50 (IP)

TORXPLUS® Bit Sockets
TORXPLUS® Bit-Steckschlüssel
Douilles tournevis, TORXPLUS®

TORXplus®

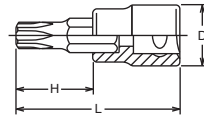

RS3025/8-IP	8 Pieces Set/Rail 200mm	(g)
20IP, 25IP, 27IP, 30IP, 40IP, 45IP, 50IP, 55IP		370

RS3025/8-IP

Socket Set on Rail
Steckschlüsselsatz auf Schiene
Jeu de douilles sur rail



RSX025/11-IP	11 Pieces Set/Rail 200mm	(g)
2025.28(IP)	10IP, 15IP, 20IP, 25IP, 27IP	480
3025.50(IP)	30IP, 40IP, 45IP, 50IP	
4025.60(IP)	55IP, 60IP	

RSX025/11-IP

Socket Set on Rail
Steckschlüsselsatz auf Schiene
Jeu de douilles sur rail



$$\boxed{1/4"} + \boxed{3/8"} + \boxed{1/2"} = \boxed{1"} + \boxed{1/4"} = \boxed{1.25"} = \boxed{31.75 \text{ mm}}$$

TORXPLUS® (IP)

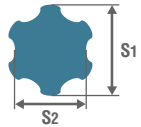

IP		8IP	9IP	10IP	15IP	20IP	25IP	27IP	30IP	40IP	45IP	50IP	55IP	60IP	70IP
S ₁	(ref. mm)	2.3	2.5	2.7	3.3	3.9	4.5	5.0	5.6	6.7	7.9	8.9	11.3	13.3	15.6
S ₂	(ref. mm)	1.8	1.9	2.1	2.5	3.0	3.4	3.9	4.3	5.2	6.2	6.9	9.0	10.4	12.3

TORXplus®

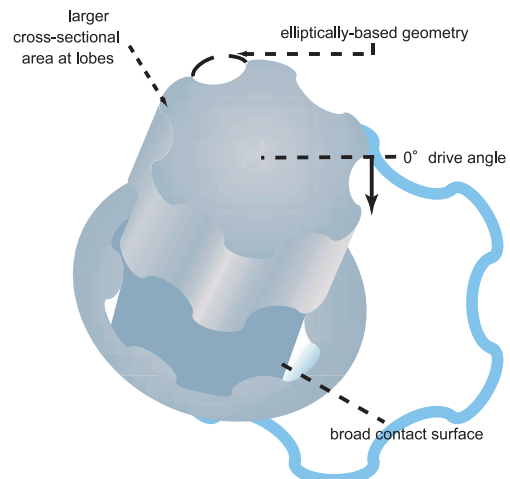
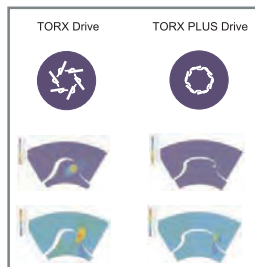
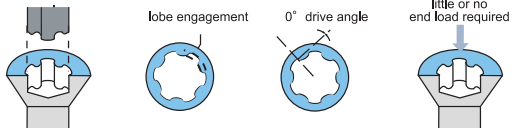

3025-50 (IPR)



Tamper-Resistant TORXPLUS® Bit Sockets
Tamper-Resistant TORXPLUS® Bit-Steckschlüssel
Douilles tournevis TORXPLUS® avec trou

TORXplus



3025-50 (IPR)	D (mm)	H (mm)	L (mm)	(g)	(pcs.)
10IPR	18	23.5	50	38	10
15IPR	18	23.5	50	38	10
20IPR	18	23.5	50	38	10
25IPR	18	23.5	50	38	10
27IPR	18	23.5	50	40	10
30IPR	18	23.5	50	40	10
40IPR	18	23.5	50	41	10
45IPR	18	23.5	50	41	10
50IPR	20	23.5	50	61	10
55IPR	20	23.5	50	61	10

RS3025/9-IPR



Socket Set on Rail
Steckschlüsselsatz auf Schiene
Jeu de douilles sur rail



RS3025/9-IPR	9 Pieces Set/Rail 200mm	(g)
10IPR, 15IPR, 20IPR, 25IPR, 27IPR, 30IPR, 40IPR, 45IPR, 50IPR		395

RSX025/11-IPR



Socket Set on Rail
Steckschlüsselsatz auf Schiene
Jeu de douilles sur rail



RSX025/11-IPR	11 Pieces Set/Rail 200mm	(g)
2025.28(IPR)	8IPR, 10IPR, 15IPR, 20IPR, 25IPR, 27IPR, 30IPR	320
3025.50(IPR)	40IPR, 45IPR, 50IPR, 55IPR	

1/4" + 3/8"

TORXPLUS®
(IPR)

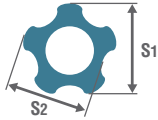

IPR	8IPR	9IPR	10IPR	15IPR	20IPR	25IPR	27IPR	30IPR	40IPR	45IPR	50IPR	55IPR	
S ₁	(ref. mm)	2.2	2.4	2.6	3.1	3.6	4.1	4.7	5.2	6.3	7.4	8.4	10.6
S ₂	(ref. mm)	2.0	2.2	2.4	2.8	3.3	3.8	4.3	4.8	5.7	6.7	7.6	9.7

3027-50 / -100



Bit Sockets for Ribbe Screws
Steckschlüsselklingen für Ribbe Schrauben
Douilles tournevis pour écrous profil Ribbe

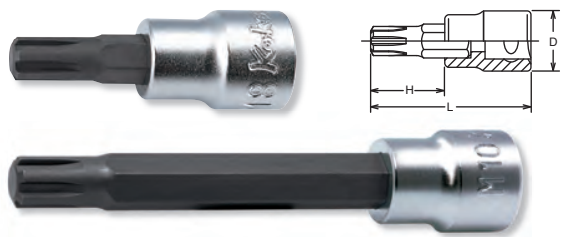

3027-50	D (mm)	H (mm)	L (mm)	(g)	(pcs.)
M 5	18	23.5	50	38	10
M 6	18	23.5	50	38	10
M 7	18	23.5	50	38	10
M 8	18	23.5	50	39	10
M 9	20	23.5	50	40	10
M10	20	23.5	50	40	10
M12	20	23.5	50	41	10

3027-100	D (mm)	H (mm)	L (mm)	(g)	(pcs.)
M 5	18	73.5	100	40	10
M 6	18	73.5	100	42	10
M 8	18	73.5	100	45	10
M10	20	73.5	100	52	10
M12	20	73.5	100	73	10

RS3027/5-L50



Socket Set on Rail
Steckschlüsselsatz auf Schiene
Jeu de douilles sur rail



RS3027/5-L50	5 Pieces Set/Rail 150mm	(g)
M5, M6, M8, M10, M12		240

Ribbe CV

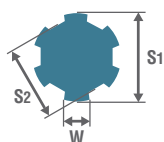

CV	M5	M6	M7	M8	M9	M10	M12	M13	M14	M16
W	(ref. mm)	1.2	1.3	1.4	1.8	2.0	2.3	2.6	3.1	3.6
S ₁	(ref. mm)	5.0	6.0	7.0	8.0	9.0	10.0	12.0	13.0	16.0
S ₂	(ref. mm)	3.8	4.5	5.0	6.0	7.1	7.4	9.0	11.0	11.9

3110M (mm)	D (mm)	H (mm)	L (mm)	(g)	(pcs.)
6	18	10	28	30	10
8	18	10	28	30	10
10	18	10	28	33	10
12	18	10	28	37	10

3110A (inch)	D (mm)	H (mm)	L (mm)	(g)	(pcs.)
5/16	18	10	28	30	10
3/8	18	10	28	33	10
1/2	18	10	28	37	10

3119 (mm)	T ₁ ×T ₂ (mm)	D ₁ (mm)	D ₂ (mm)	d (mm)	L (mm)	(g)	(pcs.)
3 x5	3 x5	17	17.3	11	30	30	10
5.5x6	5.5x6	21	19.5	14	33	45	10



For Wing Bolt
Für Flügelschrauben
Pour écrous à oreilles



For Drain Plug in Radiator
Für Kühler-Ablassschrauben
Pour le vidange du radiateur

3137	D ₁ (mm)	D ₂ (mm)	L (mm)	(g)	(pcs.)
3137	13	16.5	30	30	10

For DIN3126 C6.3 Bits
Für DIN3126 C6.3 Bits
Pour DIN3126 C6.3 Embouts

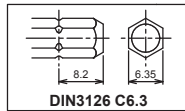

DIN3126 C6.3



3138	D ₁ (mm)	D ₂ (mm)	L (mm)	(g)	(pcs.)
3138	16	18	38	55	10

For DIN3126 C8 Bits
Für DIN3126 C8 Bits
Pour DIN3126 C8 Embouts

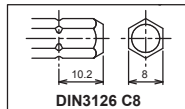

DIN3126 C8



3110M / 3110A

4-point Male Sockets
Öldienst-Steckschlüssel
Douilles mâles 4-pans

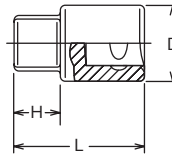

3119

Wing Bolt Socket
Steckschlüssel für Flügelschrauben
Douilles pour écrous à oreilles

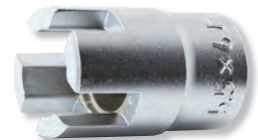
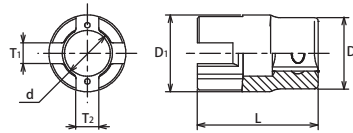

3137

Bit Holder
Klingenhalter
Porte-embouts

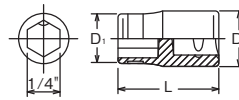

3138

Bit Holder
Klingenhalter
Porte-embouts

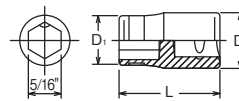

2749PS-3/8

Reversible Ratchet (Short)
Knarre kurz, verstellbar
Cliquet courte, réversible

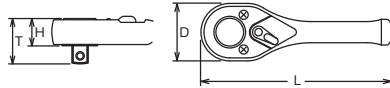

* Renewal Kits → 2749RK-3/8 → P318

	D (mm)	T (mm)	H (mm)	L (mm)	(g)	(pcs.)
2749PS-3/8	25	21.9	11.2	75	70	10

2749P-3/8

Reversible Ratchet
Knarre, verstellbar
Cliquet, réversible

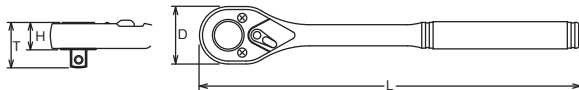

* Renewal Kits → 2749RK-3/8 → P318

	D (mm)	T (mm)	H (mm)	L (mm)	(g)	(pcs.)
2749P-3/8	25	21.9	11.2	125	101	1

⚠ 2749-3/8 series have less strength compared with normal ratchet due to the technical design. Make sure to use the ratchet correctly.

3749S

Reversible Ratchet (Short)
Knarre kurz, verstellbar
Cliquet courte, réversible



* Renewal Kits → 3749RK → P318

3749SB

Reversible Ratchet with quick release button
Knarre, verstellbar mit Entriegelungsknopf
Cliquet, réversible avec bouton de débrayage

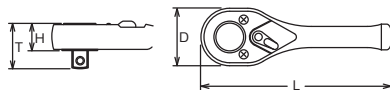

* Renewal Kits → 3749BRK → P318

	D (mm)	T (mm)	H (mm)	L (mm)	(g)	(pcs.)
3749S	34	24.8	14.1	110	183	5
3749SB	34	24.8	14.1	110	183	5

⚠ Reversible Ratchet with quick release button has less strength compared with normal ratchet due to the technical design. Make sure to use the ratchet correctly.

3753SM

Multi Purpose Ratchet, reversible
Knarre mit 2 Vierkantöffnungen, umstellbar
Cliquet réversible deux carrés femelles, réversibles

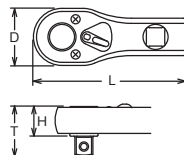

* Renewal Kits → 3753RK → P318

	D (mm)	T (mm)	H (mm)	L (mm)	(g)	(pcs.)
3753SM	30.5	26.4	15.7	81	175	5

3753SMB

Multi Purpose Ratchet, reversible, with quick release button
Knarre mit 2 Vierkantöffnungen, mit Entriegelungsknopf umstellbar
Cliquet réversible deux carrés, avec bouton de débrayage

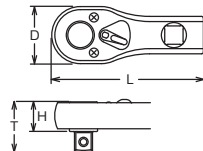

* Renewal Kits → 3753BRK → P318

	D (mm)	T (mm)	H (mm)	L (mm)	(g)	(pcs.)
3753SMB	30.5	26.4	15.7	81	175	5



3/8"

Hand Sockets Hand Steckschlüssel Douilles à main

[L/R Marking]



* Renewal Kits → 3752RK → P319



* Renewal Kits → 3752RK → P319

A pointer and L/R markings on the ratchet head indicate the turning direction.
The reduced diameter of the head allows easier access in tight spots.

Eine L/R Markierung auf dem Knarrenkopf zeigt die gerade eingestellte Drehrichtung an. Der geringe Kopfdurchmesser erleichtert das Arbeiten auch an schwer zugänglichen Stellen.

Un marquage L/R sur la tête de cliquet indique le sens de rotation.
Le diamètre de tête réduit facilite le travail dans les endroits difficilement accessibles.

	D (mm)	T (mm)	H (mm)	L (mm)	(g)	(pce.)
3752J	33	34.3	23.9	200	310	1
3752N	33	34.3	23.9	200	310	1



3752J Reversible Ratchet
Knarre, verstellbar
Cliquet, réversible



3752N Reversible Ratchet
Knarre, verstellbar
Cliquet, réversible

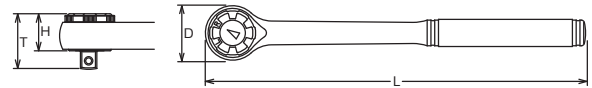

* Renewal Kits → 3753RK → P318



* Renewal Kits → 3753RK → P318



* Renewal Kits → 3753RK → P318



* Renewal Kits → 3753RK → P318

3753J Reversible Ratchet
Knarre, verstellbar
Cliquet, réversible



3753P Reversible Ratchet
Knarre, verstellbar
Cliquet, réversible



3753N Reversible Ratchet
Knarre, verstellbar
Cliquet, réversible



D3753J Reversible Ratchet
Knarre, verstellbar
Cliquet, réversible



	D (mm)	T (mm)	H (mm)	L (mm)	(g)	(pce.)
3753J	30.5	26.4	15.7	200	260	1
3753P	30.5	26.4	15.7	200	286	1
3753N	30.5	26.4	15.7	200	320	1
D3753J	30.5	26.4	15.7	200	260	1

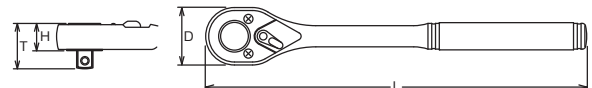

* Renewal Kits → 3753RK → P318



3753P-250 Reversible Ratchet (Long)
Verstellbare Knarre, lang
Cliquet réversible, long

	D (mm)	T (mm)	H (mm)	L (mm)	(g)	(pce.)
3753P-250	30.5	26.4	15.7	250	335	1

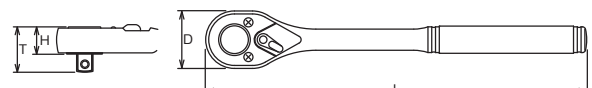

3753P-250 have longer handle than standard, and can be loaded to excessive torque value. In the interest of your own safety always apply load evenly and progressively to avoid breakage and possible injury.

Z-SERIES

HAND

TITANIUM

ACCESSORIES

SCREWDRIVERS

IMPACT

SLEEVE-DRIVE

PROTECTOR

INDUSTRIAL

AUTOMOTIVE

MOTORCYCLE

CONSTRUCTION

SPARE PART

Hand Sockets Hand Steckschlüssel Douilles à main

3/8"

3753JB Reversible Ratchet with quick release button
Knarre, verstellbar mit Entriegelungsknopf
Cliquet, réversible avec bouton de débrayage



* Renewal Kits → **3753BRK** → P318

3753PB Reversible Ratchet with quick release button
Knarre, verstellbar mit Entriegelungsknopf
Cliquet, réversible avec bouton de débrayage



* Renewal Kits → **3753BRK** → P318

3753NB Reversible Ratchet with quick release button
Knarre, verstellbar mit Entriegelungsknopf
Cliquet, réversible avec bouton de débrayage



* Renewal Kits → **3753BRK** → P318

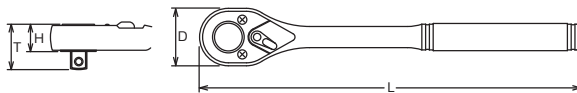

	D (mm)	T (mm)	H (mm)	L (mm)	(g)	(pce.)
3753JB	30.5	26.4	15.7	200	260	1
3753PB	30.5	26.4	15.7	200	286	1
3753NB	30.5	26.4	15.7	200	320	1

⚠ Reversible Ratchet with quick release button has less strength compared with normal ratchet due to the technical design. Make sure to use the ratchet correctly.

Die Umschaltknarre mit Entriegelungsknopf hat aufgrund der technischen Konstruktion eine geringere Festigkeit als eine normale Ratsche. Stellen Sie sicher, dass Sie die Ratsche richtig verwenden.

Le cliquet réversible avec bouton de débrayage a une résistance moindre que le cliquet normal en raison de sa conception technique. Veuillez utiliser le cliquet correctement.

2774JS-3/8 Flexible Ratchet, reversible
Gelenk-Knarre, verstellbar
Cliquet articulé, réversible



* Renewal Kits → **2749RK-3/8** → P318

2774PS-3/8 Flexible Ratchet, reversible
Gelenk-Knarre, verstellbar
Cliquet articulé, réversible



* Renewal Kits → **2749RK-3/8** → P318

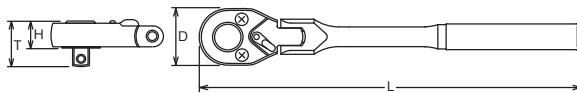

	D (mm)	T (mm)	H (mm)	L (mm)	(g)	(pce.)
2774JS-3/8	25	21.9	11.2	120	113	1
2774PS-3/8	25	21.9	11.2	120	133	1

⚠ 2774-3/8 series have less strength compared with normal  ratchet due to the technical design. Make sure to use the ratchet correctly.

3774PS Flexible Ratchet, reversible
Gelenk-Knarre, verstellbar
Cliquet articulé, réversible



* Renewal Kits → **3753RK** → P318

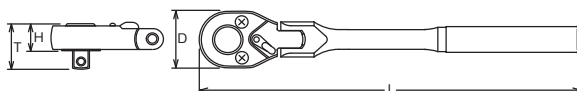

	D (mm)	T (mm)	H (mm)	L (mm)	(g)	(pce.)
3774PS	30.5	26.4	15.7	175	250	1

Z-SERIES

HAND

TITANIUM

SCREWDRIVERS ACCESSORIES

IMPACT

SLEEVE-DRIVE

PROTECTOR

INDUSTRIAL

AUTOMOTIVE

MOTORCYCLE

CONSTRUCTION

SPARE PART

3/8" Hand Sockets Hand Steckschlüssel Douilles à main

Z-SERIES
HAND
TITANIUM
ACCESSORIES
SCREWDRIVERS
IMPACT
SLEEVE-DRIVE
PROTECTOR
INDUSTRIAL
AUTOMOTIVE
MOTORCYCLE
CONSTRUCTION
SPARE PART



3774J Flexible Ratchet, reversible
Gelenk-Knarre, verstellbar
Cliquet articulé, réversible

* Renewal Kits → 3753RK → P318



3774P Flexible Ratchet, reversible
Gelenk-Knarre, verstellbar
Cliquet articulé, réversible

* Renewal Kits → 3753RK → P318



3774N Flexible Ratchet, reversible
Gelenk-Knarre, verstellbar
Cliquet articulé, réversible

* Renewal Kits → 3753RK → P318



	D (mm)	T (mm)	H (mm)	L (mm)	(g)	(pce.)
3774J	30.5	26.4	15.7	285	367	1
3774P	30.5	26.4	15.7	265	378	1
3774N	30.5	26.4	15.7	265	378	1

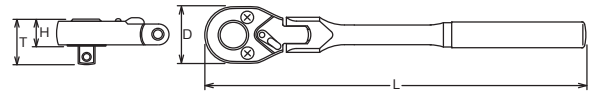

* Renewal Kits → 3753BRK → P318

3774JB Flexible Ratchet, reversible with quick release button
3774PB Gelenk-Knarre, verstellbar mit Entriegelungsknopf
3774NB Cliquet, articulée, réversible avec bouton de débrayage



	D (mm)	T (mm)	H (mm)	L (mm)	(g)	(pce.)
3774JB	30.5	26.4	15.7	285	367	1
3774PB	30.5	26.4	15.7	265	373	1
3774NB	30.5	26.4	15.7	265	378	1

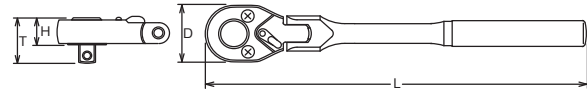

Warning: Reversible Ratchet with quick release button has less strength compared with normal ratchet due to the technical design. Make sure to use the ratchet correctly.

Die Umschaltknarre mit Entriegelungsknopf hat aufgrund der technischen Konstruktion eine geringere Festigkeit als eine normale Ratsche. Stellen Sie sicher, dass Sie die Ratsche richtig verwenden.

Le cliquet réversible avec bouton de libération rapide a une résistance moindre que le cliquet normal en raison de sa conception technique. Veillez à utiliser le cliquet correctement.

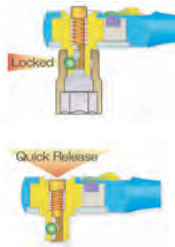

Reversible Ratchet with Quick Release Button :
Sockets and accessories are safely locked. By pushing the button the sockets or extension bars are released from the ratchet.

Umstellbare Knarre mit Entriegelungsknopf :
Steckschlüssel und Zubehörteile werden sicher und fest gehalten. Bei Drücken des Knopfes lösen sich die Teile.

Cliquet réversible avec bouton de débrayage :
Les douilles et accessoires ne peuvent plus se libérer. Une pression du pouce sur le bouton suffit pour les extraire.

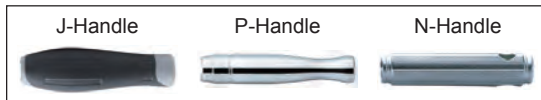

* Renewal Kits → 3753BRK → P318

3774JL Flex-Head Ratchet with Head Lock Button
3774PL Gelenk-Knarre, mit feststellbarem Gelenk
3774NL Cliquet à tête articulée avec bouton de blocage



	D (mm)	T (mm)	H (mm)	L (mm)	(g)	(pce.)
3774JL	30.5	26.4	15.7	285	367	1
3774PL	30.5	26.4	15.7	265	378	1
3774NL	30.5	26.4	15.7	265	378	1

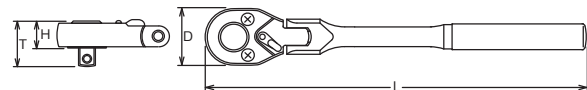

3774JBL Flex-Head Ratchet with Head Lock Button and Quick Release Button

Gelenk-Knarre, mit feststellbarem Gelenk und Entriegelungsknopf
Cliquet à tête articulée avec bouton de blocage et de débrayage



* Renewal Kits → 3753BRK → P318

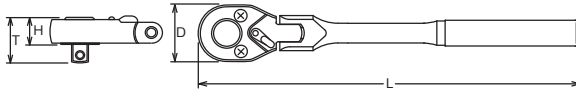

	D (mm)	T (mm)	H (mm)	L (mm)	(g)	(pce.)
3774JBL	30.5	26.4	15.7	285	367	1

⚠ Reversible Ratchet with quick release button has less strength compared with normal ratchet due to the technical design. Make sure to use the ratchet correctly.

Die Umschaltknarre mit Entriegelungsknopf hat aufgrund der technischen Konstruktion eine geringere Festigkeit als eine normale Ratsche. Stellen Sie sicher, dass Sie die Ratsche richtig verwenden.

Le cliquet réversible avec bouton de débrayage rapide a une résistance moindre que le cliquet normal en raison de sa conception technique. Veuillez utiliser le cliquet correctement.

3774P-SR Speeder Ratchet

Kurbel-Knarre
Vilebrequin à cliquet

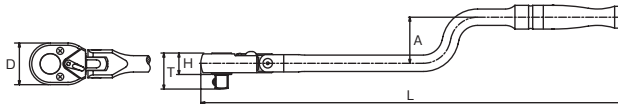

* Renewal Kits → 3753RK → P318



	D (mm)	T (mm)	H (mm)	A (mm)	L (mm)	(g)	(pce.)
3774P-SR	30.5	26.4	15.7	34	310	435	1

3776J Swivel Head Ratchet

Schwenkopf-Knarre
Cliquet à tête pivotante



* Renewal Kits → 3752RK → P319



3776P Swivel Head Ratchet

Schwenkopf-Knarre
Cliquet à tête pivotante



* Renewal Kits → 3752RK → P319

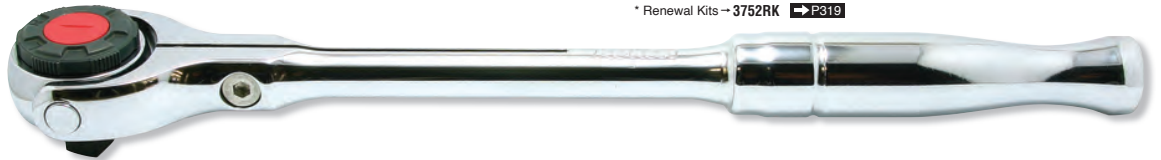

3776N Swivel Head Ratchet

Schwenkopf-Knarre
Cliquet à tête pivotante



* Renewal Kits → 3752RK → P319

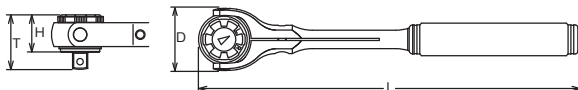

	D (mm)	T (mm)	H (mm)	L (mm)	(g)	(pce.)
3776J	44	34.3	23.9	280	510	1
3776P	44	34.3	23.9	280	560	1
3776N	44	34.3	23.9	280	565	1



* Renewal Kits → 3755RK → P319

	D (mm)	L (mm)	(g)	(pcs.)
3755	30.5	55	146	5

3755 Ratchet Adaptor
Aufsteckknarre
Cliquet adaptable

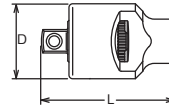

	D (mm)	L (mm)	(g)	(pcs.)
3756	30.5	25.5	47	10

3756 Quick Spinner
Rändel-Drehscheibe
Lanceur

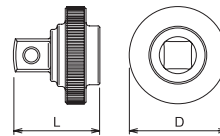

* Renewal Kits → 3752RK → P319

	D (mm)	L (mm)	(g)	(pcs.)
3757	50	35	155	5

3757 Ratchet Wheel
Umstellbares Knarren-Handrad
Cliquet réversible à roue

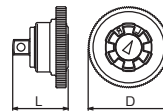
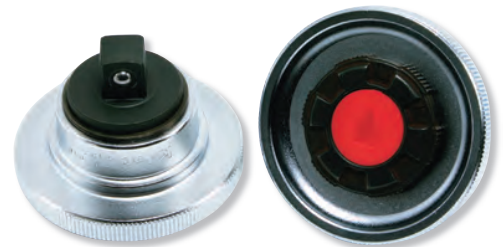

3762 Flexible Extension Bar
Biegsame Verlängerung
Rallonge flexible

	D (mm)	L (mm)	(g)	(pcs.)
3762	19.3	300	178	2

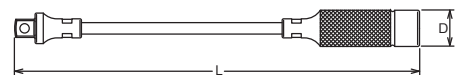

3760 Extension Bars Verlängerungen Rallonges

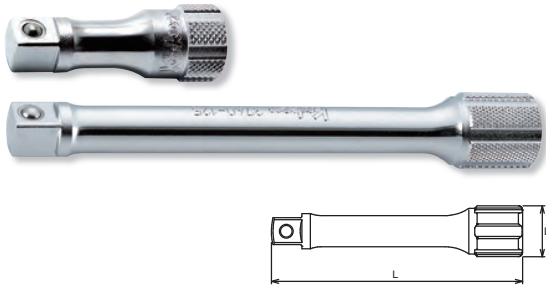

	D (mm)	L (mm)	(g)	(pcs.)
3760-32	18	32	27	10
3760-50	18	50	47	10
3760-75	18	75	68	10
3760-125	18	125	106	10
3760-150	18	150	125	10
3760-250	18	250	196	5
3760-300	18	300	291	2
3760-400	18	400	365	1
3760-500	18	500	490	1
3760-600	18	600	538	1
3760-900	18	900	805	1
3760-1000	18	1000	968	1

PK3760/6 Extension Set in Plastic Box Verlängerungen in Kunststoffkassette Jeu de rallonges en boîte plastique



PK3760/6 6 Pieces Set/△=670g

PLASTIC TRAY	
Extension Bars	
3760 Extension Bars 32, 50, 75, 125, 150, 250	

Rotation and general handling of extensions with oily hands is greatly improved with the **Koken** developed 6 point knurling. Also the **Koken** 6 point knurling stops the extensions from rolling around the work area.



Durch die von **Koken** entwickelte 6 fache Rändelung wird die Handhabung deutlich erleichtert. Außerdem wird das Herumrollen der Verlängerungen wirksam verhindert.

La manipulation des rallonges est grandement facilitée par le profil moleté développé par **Koken**. Ce même profil empêche le roulement interpestif des rallonges sur le plan de travail.

3763 Wobble-Fix Extension Bars Winkel-Verlängerungen Rallonges angulaires

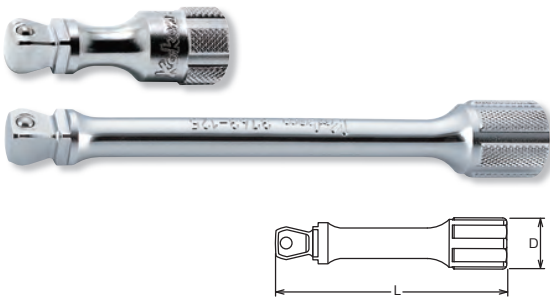

	D (mm)	L (mm)	(g)	(pcs.)
3763-32	18	32	26	10
3763-50	18	50	42	10
3763-75	18	75	57	10
3763-125	18	125	80	10
3763-150	18	150	98	10
3763-250	18	250	144	5
3763-300	18	300	170	2

PK3763/6 Wobble-Fix Extension Bars in Plastic Box Winkel-Verlängerungen in Kunststoffkassette Jeu de rallonges angulaires en boîte plastique



PK3763/6 6 Pieces Set/△=560g

PLASTIC TRAY	
Extension Bars	
3763 Wobble-Fix Extension Bars 32, 50, 75, 125, 150, 250	

Wobble-Fix Extension Bar

- Two way usage
a) In a fixed position, as a normal extension bar
b) In a half-fixed position, as a flexible extension bar providing a 15° angle operation

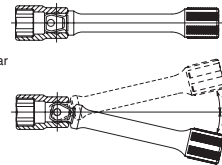

Winkel-Verlängerungen

- Winkelverlängerungen lassen sich in zwei Einstellungen verwenden
a) voll eingesteckt und starr,
b) halb eingesteckt, mit einem Arbeitswinkel von 15°.

Rallonges angulaires

- Deux utilisations possibles
a) comme rallonge normale, dans une position fixe
b) comme une rallonge angulaire avec une possibilité d'inclinaison jusqu'à 15°

⚠ The Wobble-Fix Extension Bar has less strength than normal extension bar due to its specific design with a reduced square drive. Make sure to use it correctly.

Die Wobble-Fix Verlängerungen haben aufgrund ihrer speziellen Konstruktion mit einem reduzierten Vierkanttrieb eine geringere Festigkeit als eine normale Verlängerung. Achten Sie darauf, sie richtig zu verwenden.

La barre d'extension wobble-fix est moins résistante qu'une barre d'extension normale en raison de sa conception spécifique avec un carré d'entraînement réduit. Veuillez l'utiliser correctement.



* Renewal Kits → 3768RK → P321



OVAL SHAPE SHANK



RENEWAL KIT FOR HINGE HANDLE

3768J-250

Hinge Handle
Gelenkgriff
Poignée articulée



* Renewal Kits → 3768RK → P321

3768P-250

Hinge Handle
Gelenkgriff
Poignée articulée



* Renewal Kits → 3768RK → P321

3768P-380

Hinge Handle
Gelenkgriff
Poignée articulée



	D (mm)	L (mm)	(g)	(pcs.)
3768J-250	20.5	250	248	2
3768P-250	20.5	250	275	5
3768P-380	20.5	380	435	2

! 3768P-380 has longer handle than standard, and can be loaded to excessive torque value. In the interest of your own safety always apply load evenly and progressively to avoid breakage and possible injury.

Der Gelenkgriff 3768-380 ist länger als die Standardversion. Aus Gründen Ihrer Sicherheit, sollten dies Werkzeug nie ruckartig sondern nach und nach belastet werden, um Bruch und damit verbundene, mögliche Verletzungen zu vermeiden.

Dû au fait que les manches des 3768-380 sont plus longues que le standard, il y a risque d'une surcharge excessive lors du serrage. Pour éviter casse et blessure, veuillez serrer d'une façon régulière et progressive.

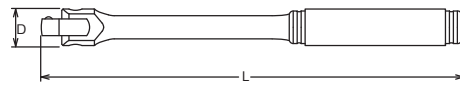

3769N-160 / -230

Spin Type Handle
Drehgriff
Poignée emmanchée

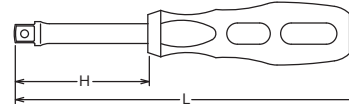

3769NWF-160 / -230

Spin Type Handle Wobble-Fix
Drehgriff, Wobble-Fix
Poignée emmanchée, angulaire

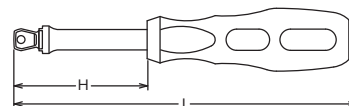

3769H

Folding Socket Driver
Klapp-Drehgriff
Poignée tournevis articulée

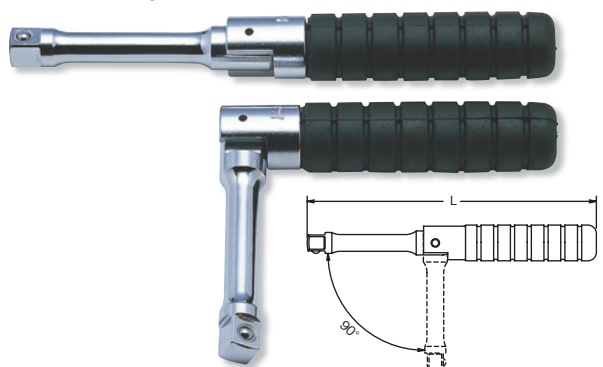

	H (mm)	L (mm)	(g)	(pcs.)
3769N	50	160	110	2
230	120	230	135	2



WOBBLE-FIX EXTENSION BAR



	H (mm)	L (mm)	(g)	(pcs.)
3769NWF	50	160	110	2
230	120	230	135	2

! Plastic or rubber handles are not intended to act as insulation.

Plastik- oder Gummigriffe stellen keinen Isolierschutz dar.

Les poignées en plastique ou en caoutchouc ne garantissent aucune isolation électrique.

	L (mm)	(g)	(pcs.)
3769H	170	210	2

3770 Universal Joint
Gelenk-Einsatz
Cardan universel

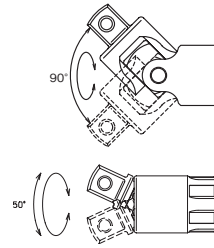
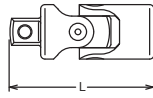

3771 Universal Joint
Gelenk-Einsatz
Joint articulé

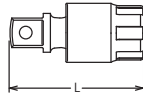

	L (mm)	(g)	(pcs.)
3770	50	66	10
3771	43	46	10

3780 Speed Handle
Winde
Vilebrequin

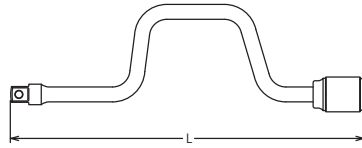

	L (mm)	(g)	(pcs.)
3780	400	432	1

3785 T-Handle
T-Griff
Poignée coulissante

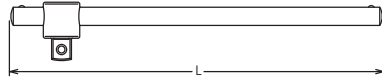
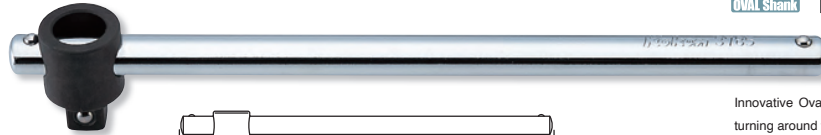

Innovative Oval shaped bar provides higher durability and stops the sliding square part turning around the bar.



	L (mm)	(g)	(pcs.)
3785	200	157	5

3322A Adaptor
Verbindungsstück
Augmentateur

Warranty 86Nm
Garantie 86Nm
Garantie 86Nm



3344A Adaptor
Verbindungsstück
Augmentateur

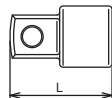

	(sq.)	(sq.)	L (mm)	(g)	(pcs.)
3322A	3/8"	1/4"	24	18	10
3344A	3/8"	1/2"	30	35	10

⚠ Adapting down from bigger square drive to smaller square drive may lead to excessive torque and possibly cause breakage.

Reduzierstücke sind mit Vernunft einzusetzen.
Es besteht Bruchgefahr. Überschreiten Sie niemals die Sicherheitsgrenzen.

Les réducteurs doivent être utilisés avec modération. Ne dépassez jamais la limite de sécurité.

PK2346/6 Adaptor Set in Plastic Box
Adaptor Satz in Kunststoffkassette
Jeu de adaptateur en boîte plastique







- 2233A (1/4" X 3/8"
- 3322A (3/8" X 1/4" Warranty/Garantia 86Nm
- 3344A (3/8" X 1/2"
- 4433A (1/2" X 3/8" Warranty/Garantia 290Nm
- 4466A (1/2" X 3/4"
- 6644A (3/4" X 1/2" Warranty/Garantia 668Nm

PK2346/6 6 Pieces Set/△=460g
PLASTIC TRAY

Adaptors			
1/4" □ → 3/8" ▨	2233A	3/8" □ → 1/4" ▨	3322A
3/8" □ → 1/2" ▨	3344A	1/2" □ → 3/8" ▨	4433A-35
1/2" □ → 3/4" ▨	4466A	3/4" □ → 1/2" ▨	6644A

3/8"

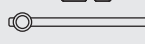
Hand Sockets
Hand Steckschlüssel
Douilles à main

ESH3001 17 Pieces Set/Δ=2,200g	
METAL CASE:W415xH120xT50mm	
Sockets	Accessories
3410M Surface Drive Sockets 8, 9, 10, 11, 12, 13, 14, 15, 16, 17, 18, 19	 3753J  3760-125  3760-250  3770  3785









ESH3001 Socket Set
Steckschlüssel Satz
Jeu de clés à douille

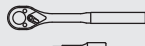

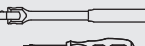
ETH3001 22 Pieces Set/Δ=1,820g	
METAL CASE:W392xH90xT50mm	
Sockets	Accessory
3425 TORX® Sockets E4, E5, E6, E7, E8 4425 TORX® Sockets E10, E11, E12, E14, E16, E18 3025.50 TORX® Bit Sockets T10, T15, T20, T25, T27 4025.60 TORX® Bit Sockets T30, T40, T45, T50, T55	 4433A-35

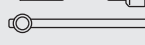

ETH3001 Socket Set
Steckschlüssel Satz
Jeu de clés à douille



3201AMW 42 Pieces Set/Δ=4,700g	
METAL CASE:W445xH190xT50mm	
Sockets	Accessories
3405M 12-pt. Sockets 9, 10, 11, 12, 13, 14, 15, 16, 17, 18, 19, 20, 21, 22 3405A 12-pt. Sockets 5/16, 3/8, 7/16, 1/2, 9/16, 5/8, 11/16, 3/4, 25/32, 13/16, 7/8 3405W 12-pt. Sockets 1/8, 3/16, 1/4, 5/16, 3/8, 7/16, 1/2	 3753N  3760-75  3760-125  3760-250  3768N-250  3769N-160  3770  3780  3785  3344A

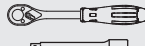

3201AMW Socket Set
Steckschlüssel Satz
Jeu de clés à douille

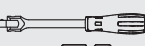
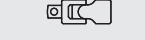
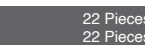

3206AM 27 Pieces Set/Δ=3,500g	
METAL CASE:W445xH190xT50mm	
Sockets	Accessories
3405M 12-pt. Sockets 7, 8, 10, 11, 12, 13, 14, 15, 16, 17, 19, 22 3405A 12-pt. Sockets 3/8, 7/16, 1/2, 9/16, 5/8, 11/16, 3/4, 13/16, 7/8 3300C Spark Plug Socket 20.8	 3753J  3760-125  3760-250  3768J-250  3770



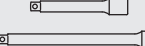

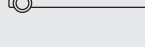
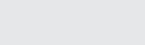

3206AM Socket Set
Steckschlüssel Satz
Jeu de clés à douille

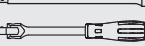

3210M-00 22 Pieces Set/Δ=2,900g	
3210M-05 22 Pieces Set/Δ=2,900g	
3210M-10 22 Pieces Set/Δ=2,900g	
METAL CASE:W360xH145xT50mm	
Sockets	Accessories
(3210M-00) 3400M 6-pt. Sockets 6, 7, 8, 9, 10, 11, 12, 13, 14, 15, 16, 17, 18, 19, 21, 22 (3210M-05) 3405M 12-pt. Sockets 6, 7, 8, 9, 10, 11, 12, 13, 14, 15, 16, 17, 18, 19, 21, 22 (3210M-10) 3410M Surface Drive Sockets 6, 7, 8, 9, 10, 11, 12, 13, 14, 15, 16, 17, 18, 19, 21, 22	 3753J  3760-125  3760-250  3768J-250  3770  3785

3210M-00 / 3210A-00
3210M-05 / 3210A-05
3210M-10 Socket Set
Steckschlüssel Satz
Jeu de clés à douille

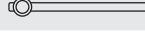

3210A-00 18 Pieces Set/Δ=2,760g	
3210A-05 18 Pieces Set/Δ=2,760g	
METAL CASE:W360xH145xT50mm	
Sockets	Accessories
(3210A-00) 3400A 6-pt. Sockets 1/4, 5/16, 11/32, 3/8, 7/16, 1/2, 9/16, 5/8, 11/16, 3/4, 13/16, 7/8 (3210A-05) 3405A 12-pt. Sockets 1/4, 5/16, 11/32, 3/8, 7/16, 1/2, 9/16, 5/8, 11/16, 3/4, 13/16, 7/8	 3753J  3760-125  3760-250  3768J-250  3770  3785

3216 Spark Plug Sockets Set
Zündkerzen-Schlüssel Satz
Jeu de douilles pour bougies



3216 4 Pieces Set/△=730g	
PLASTIC BAG	
Sockets	Accessories
3300C Spark Plug Sockets 16, 20.8	3760-125 3774JL

3217M-00 Socket Set
Steckschlüssel Satz
Jeu de clés à douille



3217M-00	14 Pieces Set/△=850g
3217M-05	14 Pieces Set/△=850g
3217M-10	14 Pieces Set/△=850g

METAL CASE:W163xH52xT33mm	
Sockets	
(3217M-00)	
3400M 6-pt. Sockets 9, 10, 11, 12, 13, 14, 15, 16, 17, 18, 19, 20, 21, 22	
(3217M-05)	
3405M 12-pt. Sockets 9, 10, 11, 12, 13, 14, 15, 16, 17, 18, 19, 20, 21, 22	
(3217M-10)	
3410M Surface Drive Sockets 9, 10, 11, 12, 13, 14, 15, 16, 17, 18, 19, 20, 21, 22	

S3240M-00 / S3240A-00 Display Stands
Ausstellungsstände
S3240M-05 / S3240A-05 Présentoirs



S3240M-00	3400M 177 Pieces Set/△=10,300g
S3240M-05	3405M 177 Pieces Set/△=10,300g

DISPLAY STAND:W510xH150xT230mm		
Sockets		
6mm:12pcs	12mm:12pcs	18mm:8pcs
7mm:12pcs	13mm:11pcs	19mm:8pcs
8mm:12pcs	14mm:11pcs	20mm:7pcs
9mm:12pcs	15mm:10pcs	21mm:7pcs
10mm:12pcs	16mm: 9pcs	22mm:7pcs
11mm:12pcs	17mm: 9pcs	23mm:6pcs

S3240A-00	3400A 126 Pieces Set/△=8,500g
S3240A-05	3405A 126 Pieces Set/△=8,500g





DISPLAY STAND:W510xH150xT230mm		
Sockets		
1/4" :12pcs	9/16":10pcs	25/32":7pcs
5/16":12pcs	19/32":10pcs	13/16":7pcs
3/8" :12pcs	5/8" : 9pcs	7/8" :7pcs
7/16":12pcs	11/16": 9pcs	
1/2" :11pcs	3/4" : 8pcs	

3250M-00 Socket Set
Steckschlüssel Satz
Jeu de clés à douille







3250M-00	17 Pieces Set/△=2,200g
3250M-05	17 Pieces Set/△=2,200g

METAL CASE:W415xH120xT50mm	
Sockets	Accessories
3400M 6-pt. Sockets 7, 8, 10, 11, 12, 13, 14, 15, 16, 17, 18, 19	3753J 3760-125 3760-250
3405M 12-pt. Sockets 7, 8, 10, 11, 12, 13, 14, 15, 16, 17, 18, 19	3770 3785

3251		8 Pieces Set/△=675g	
METAL CASE:W160×H100×T28mm			
Sockets	Accessories		
 3025.50 TORX® Bit Sockets T25H, T30H, T40H, T45H, T50H		2774PS-3/8	
		3763-50	
		3756	

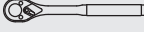





3251 Bit Socket Set
Schraubendreher-Steckschlüssel Satz
Jeu de douilles de vissage

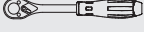

3252M		15 Pieces Set/△=1,530g	
METAL CASE:W310×H90×T48mm			
Sockets	Accessories		
 3400M 6-pt. Sockets 5.5, 7, 8, 10, 11, 12		3753P	
 3405M 12-pt. Sockets 13, 14, 17, 19, 22		3760-75	
		3760-125	
		3770	



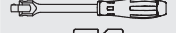



3252M Socket Set
Steckschlüssel Satz
Jeu de clés à douille

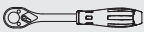

3275		24 Pieces Set/△=3,150g	
METAL CASE:W400×H147×T50mm			
Sockets	Accessories		
 3400M 6-pt. Sockets 6, 7, 8, 9, 10, 11, 12		3753J	
 3405M 12-pt. Sockets 13, 14, 15, 16, 17, 18, 19, 21, 22		3760-125	
 3300C Spark Plug Sockets 16, 20.8		3768J-250	
		3770	
		3756	



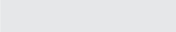



3275 Socket Set
Steckschlüssel Satz
Jeu de clés à douille



3277		29 Pieces Set/△=3,240g	
METAL CASE:W370×H150×T50mm			
Sockets	Accessories		
 3400M 6-pt. Sockets 8, 9, 10, 11, 12		3753J	
 3405M 12-pt. Sockets 13, 14, 15, 16, 17, 18, 19, 21		3760-125	
 3300M 6-pt. Deep Sockets 8, 9, 10, 11, 12		3768J-250	
 3305M 12-pt. Deep Sockets 13, 14, 15, 16, 17, 18, 19, 21		3770	

3277 Socket Set
Steckschlüssel Satz
Jeu de clés à douille



3278		20 Pieces Set/△=3,370g	
METAL CASE:W310×H150×T50mm			
Sockets	Accessories		
 3000 Bit Sockets 2, 3		3753J	
 3010M.62 Hex Bit Sockets 5, 6, 7, 8, 10		3763-125	
 3020.50 XZN Bit Sockets M4, M5, M6, M8			
 3025.50 TORX® Bit Sockets T10, T15, T20, T25, T27, T30, T40			

3278 Bit Socket Set
Schraubendreher-Steckschlüssel Satz
Jeu de douilles de vissage



Z-SERIES
HAND
TITANIUM
ACCESSORIES
SCREWDRIVERS
IMPACT
SLEEVE-DRIVE
PROTECTOR
INDUSTRIAL
AUTOMOTIVE
MOTORCYCLE
CONSTRUCTION
SPARE PART

4401M

6-point Sockets
6-kant Steckschlüssel
Douilles 6-pans



HANDY-ENDY®

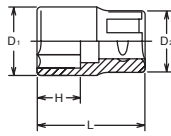

4401M 4406M (mm)	D ₁ (mm)	D ₂ (mm)	H (mm)	L (mm)	(g)	(pcs.)
8	13.2	22	8	36	44	10
9	13.8	22	8.5	37	44	10
10	15.3	22	9	37	45	10
11	16.5	22	9.5	37	46	10
12	17.8	22	10	37	47	10
13	19	22	10.5	37	53	10
14	20.3	22	11	37	56	10
15	21.5	22	11.5	37	52	10
16	22.8	22	12	37	62	10
17	24	22	12.5	37	69	10
18	25	23	13	37	74	10
19	26.5	24.5	14	38	89	10
20	27.8	26	15	38	92	10
21	29	27	15.5	38	102	10
22	30	28	16	40	113	10
23	31.5	29	16.5	40	128	10
24	32.8	30	17	42	140	5
25	34	31	18	42	164	5
26	35	32	19	42	165	5
27	36.5	33	19.5	43	196	5
28	37.8	34	20	43	198	5
29	39	35	20.5	43	190	5
30	40	36	22	46	222	5
31	41.5	37	22.5	46	257	5
32	42.8	38	23	46	250	5

4406M

12-point Sockets
12-kant Steckschlüssel
Douilles 12-pans



HANDY-ENDY®

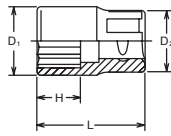

4400M

6-point Sockets
6-kant Steckschlüssel
Douilles 6-pans

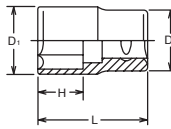

4400M 4405M (mm)	D ₁ (mm)	D ₂ (mm)	H (mm)	L (mm)	(g)	(pcs.)
33	44.2	39	24	47	275	5
34	45.2	40	24	47	315	5
35	46.2	40	24	47	317	5
36	47.2	41	24	47	336	5
37	48.3	42	24	47	360	5
38	49.2	43	24	47	380	5
41	53.1	45	29	57	471	5
46	59.1	48	32	60	567	2

4405M

12-point Sockets
12-kant Steckschlüssel
Douilles 12-pans

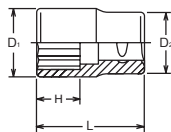

RS4401M/10

Socket Set on Rail
Steckschlüsselsatz auf Schiene
Jeu de douilles sur rail



RS4401M/10	10 Pieces Set/Rail 300mm	(g)
10, 11, 12, 13, 14, 15, 16, 17, 18, 19		720

RS4406M/10

Socket Set on Rail
Steckschlüsselsatz auf Schiene
Jeu de douilles sur rail



RS4406M/10	10 Pieces Set/Rail 300mm	(g)
10, 11, 12, 13, 14, 15, 16, 17, 18, 19		720

Z-SERIES
HAND
TITANIUM
SCREWDRIVERS ACCESSORIES
IMPACT
SLEEVE-DRIVE
PROTECTOR
INDUSTRIAL
AUTOMOTIVE
CONSTRUCTION MOTORCYCLE
SPARE PART

1/2"

Hand Sockets
Hand Steckschlüssel
Douilles à main

4400A 4405A (inch)	D ₁ (mm)	D ₂ (mm)	H (mm)	L (mm)	(g)	(pcs.)
1/4	10.7	21	6	36	41	10
5/16	13.2	21	8	36	44	10
3/8	14.6	21	9	37	45	10
7/16	16.5	21	9.5	37	46	10
1/2	19	22	10.5	37	53	10
9/16	20.3	22	11	37	56	10
19/32	21.5	22	11.5	37	52	10
5/8	22.8	22	12	37	62	10
21/32	24	23	12.5	37	69	10
11/16	25	24	13	37	74	10
3/4	26.5	25	14	38	89	10
25/32	27.8	26	15	38	92	10
13/16	29	27	15.5	38	102	10
7/8	30	28	16	40	113	10
15/16	32.8	30	17	42	140	5
31/32	34	31	18	42	165	5
1	35	32	19	42	165	5
1. 1/16	36.5	33	19.5	43	180	5
1. 1/8	39	35	20.5	43	210	5
1. 3/16	40	36	22	46	222	5
1. 1/4	42.8	38	23	46	250	5
1. 5/16	44.2	39	24	47	275	5
1. 3/8	46.2	40	24	47	317	5
1. 7/16	47.2	41	24	47	336	5
1. 1/2	49.2	43	24	47	380	5

Hand Sockets

Both, 6-pt. and 12-pt. openings, are equipped with Flat Drive Openings, transferring the turning power from the corners on the flanks of nuts and bolts.

Sowohl 6-kant als auch 12-kant Steckschlüssel bieten alle Vorteile der "Flat Drive" Öffnung, die die Greifzonen auf die Flächen von Schrauben und Muttern versetzt.

Aussi bien les douilles 6-pans que 12-pans présentent tous les avantages liés au profil FLATDRIVE qui applique la force de serrage aux faces de la vis ou de l'écrou.

4400A ○ 6-point Sockets
6-kant Steckschlüssel
Douilles 6-pans

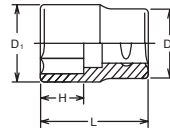

4405A ○ 12-point Sockets
12-kant Steckschlüssel
Douilles 12-pans

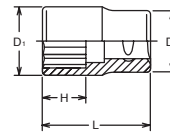

RS4400A/10	10 Pieces Set/Rail 300mm	(g)
3/8, 7/16, 1/2, 9/16, 5/8, 11/16, 3/4, 13/16, 7/8, 15/16		809
RS4405A/10	10 Pieces Set/Rail 300mm	(g)
3/8, 7/16, 1/2, 9/16, 5/8, 11/16, 3/4, 13/16, 7/8, 15/16		809

RS4400A/10 ○ ■■■■ Socket Set on Rail
Steckschlüsselsatz auf Schiene
Jeu de douilles sur rail

RS4405A/10 ○ ■■■■



	6-Point	12-Point	Surface Drive	Nut Grip®	TORX® (E)	TORXPLUS® (EPL)	Tamper-Resistant TORXPLUS® (EPRL)	Double Square	LHSTIX® (LH-S)
1/4"	No. 2400M/A No. 2300M/A No. 2400W-BA No. 2300W-BA No. 2300X series	No. 2405M/A No. 2305M/A No. AS2405A No. AS2305A series	No. 2410M No. 2310M series	No. 2450MS/AS No. 2350M No. 2350X series	No. 2425 No. 2325 series	—	—	No. 2415M/A series	—
3/8"	No. 3400M/A No. 3300M/A No. 3400W No. 3300W No. 3300X/XA series	No. 3405M/A No. 3305M/A No. 3405W No. 3305W No. 3305X/XA series	No. 3410M No. 3310M series	No. 3450M/A No. 3450MH No. 3350M No. 3350X series	No. 3425 No. 3325 series	—	—	No. 3415M/A series	No. 3400LH series
1/2"	No. 4400M/A No. 4300M/A No. 4400W series	No. 4405M/A No. 4305M/A No. 4405W series	No. 4410M No. 4310M series	No. 4450M series	No. 4425 No. 4325 series	No. 4425-EPL series	No. 4425-EPRL series	—	No. 4400LH series

Z-SERIES
HAND
TITANIUM
ACCESSORIES
SCREWDRIVERS
IMPACT
SLEEVE-DRIVE
PROTECTOR
INDUSTRIAL
AUTOMOTIVE
MOTORCYCLE
CONSTRUCTION
SPARE PART

4410M

Surface Drive Sockets
Surface Drive Steckschlüssel
Douilles, Surface Drive

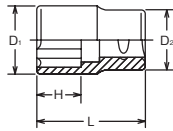

SURFACE DRIVE

RS4410M/10

Socket Set on Rail
Steckschlüsselsatz auf Schiene
Jeu de douilles sur rail



SURFACE DRIVE

Surface drive sockets are designed to retain contact with the flat sides of the nut in order to transmit high torque and reduce nut wear. These sockets are ideal for using on polished nuts, aluminum nuts and nuts with worn out points.

Das Profil unserer Surface-Drive Steckschlüssel greift die Schraube an deren Flächen. Dies sichert eine höhere Kraftübertragung und verhindert ein Durchrutschen des Steckschlüssels. Diese Steckschlüssel eignen sich besonders für polierte Schrauben, Aluminium Schrauben und Schrauben bei denen die Ecken bereits abgerundet sind.

Notre profil Surface Drive assure le contact entre la douille et les plats de l'écrou. Ceci réduit l'usure et permet la transmission d'un couple plus élevé. C'est une solution idéale pour les écrous polies, celles en aluminium ou arrondies.

4410M (mm)	D ₁ (mm)	D ₂ (mm)	H (mm)	L (mm)	(g)	(pcs.)
8	13.2	21	8	36	44	10
9	13.8	21	8.5	37	44	10
10	15.3	21	9	37	45	10
11	16.5	21	9.5	37	46	10
12	17.8	21	10	37	47	10
13	19	22	10.5	37	53	10
14	20.3	22	11	37	56	10
15	21.5	22	11.5	37	52	10
16	22.8	22	12	37	62	10
17	24	23	12.5	37	69	10
18	25	24	13	37	74	10
19	26.5	25	14	38	89	10
20	27.8	26	15	38	92	10
21	29	27	15.5	38	102	10
22	30	28	16	40	113	10
23	31.5	29	16.5	40	128	10
24	32.8	30	17	42	140	5
25	34	31	18	42	164	5
26	35	32	19	42	165	5
27	36.5	33	19.5	43	196	5
28	37.8	34	20	43	198	5
29	39	35	20.5	43	190	5
30	40	36	22	46	222	5
31	41.5	37	22.5	46	257	5
32	42.8	38	23	46	250	5
34	45.2	40	24	47	314	5

RS4410M/10	10 Pieces Set/Rail 300mm	(g)
10, 11, 12, 13, 14, 15, 17, 19, 21, 22		717

4400W 4405W (W)	D ₁ (mm)	D ₂ (mm)	H (mm)	L (mm)	(g)	(pcs.)
3/16	16.5	21	9.5	37	46	10
1/4	19	22	10.5	37	54	10
5/16	21.5	22	11.5	37	54	10
3/8	25	24	13	37	73	10
7/16	29	27	15.5	38	87	10
1/2	31.5	29	16.5	40	133	10
9/16	35	32	19	42	165	5
5/8	37.8	34	20	43	191	5
11/16	40	36	22	46	222	5
3/4	44.2	39	24	47	280	5

RS4400W/8	8 Pieces Set/Rail 250mm	(g)
3/16, 1/4, 5/16, 3/8, 7/16, 1/2, 9/16, 5/8		860

RS4405W/8	8 Pieces Set/Rail 250mm	(g)
3/16, 1/4, 5/16, 3/8, 7/16, 1/2, 9/16, 5/8		860

4400W

6-point Whitworth Sockets
6-kant Steckschlüssel, Whitworth
Douilles à 6-pans Whitworth

4405W

12-point Whitworth Sockets
12-kant Steckschlüssel, Whitworth
Douilles à 12-pans Whitworth

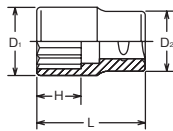

RS4400W/8

Socket Set on Rail
Steckschlüsselsatz auf Schiene
Jeu de douilles sur rail

RS4405W/8



BS W



BS - W	BS	3/16BS	1/4BS	5/16BS	3/8BS	7/16BS	1/2BS	9/16BS	5/8BS	11/16BS	3/4BS	7/8BS
	W	1/8W	3/16W	1/4W	5/16W	3/8W	7/16W	1/2W	9/16W	5/8W	11/16W	3/4W
S	(ref. mm)	8.64	11.30	13.34	15.24	18.03	20.83	23.37	25.65	27.94	30.48	33.35

4425-N

TORX® Sockets
TORX® Steckschlüssel
Douilles TORX®

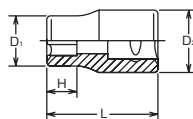

RS4425/6-N

Socket Set on Rail
Steckschlüsselsatz auf Schiene
Jeu de douilles sur rail



4425 (E)	D ₁ (mm)	D ₂ (mm)	H (mm)	L (mm)	(g)	(pcs.)
E10N	13.2	21	8.2	36	47	10
E12N	14.6	21	9.3	37	48	10
E14N	16.5	21	10.6	37	50	10
E16N	19	22	11.8	37	60	10
E18N	20.3	22	13	37	60	10
E20N	22.8	22	14.4	37	65	10

TORX Socket for Nut and low profile bolt
TORX-Steckschlüssel für Schrauben mit Flachprofil
Douille TORX pour écrou et boulon à profil bas

Shallow Chamfer on Socket Opening

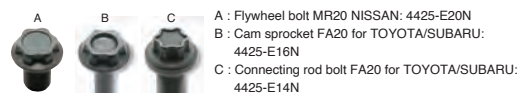

A : Flywheel bolt MR20 NISSAN: 4425-E20N
B : Cam sprocket FA20 for TOYOTA/SUBARU: 4425-E16N
C : Connecting rod bolt FA20 for TOYOTA/SUBARU: 4425-E14N

RS4425/6-N	6 Pieces Set/Rail 200mm	(g)
E10N, E12N, E14N, E16N, E18N, E20N		370

1/2"

Hand Sockets
Hand Steckschlüssel
Douilles à main

4425 (E)	D ₁ (mm)	D ₂ (mm)	H (mm)	L (mm)	(g)	(pcs.)
E 8	10.7	21	7	36	41	10
E10	13.2	21	8.2	36	44	10
E11	13.8	21	8.7	37	45	10
E12	14.6	21	9.3	37	47	10
E14	16.5	21	10.6	37	48	10
E16	19	22	11.8	37	57	10
E18	20.3	22	13	37	57	10
E20	22.8	22	14.4	37	63	10
E22	25	24	15.5	37	78	10
E24	26.5	25	17	40	95	5

RS4425/7	7 Pieces Set/Rail 200mm	(g)
E10, E12, E14, E16, E18, E20, E24		428

4425 TORX® Sockets TORX® Steckschlüssel Douilles TORX®

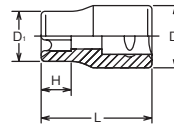

RS4425/7 Socket Set on Rail Steckschlüsselsatz auf Schiene Jeu de douilles sur rail



TORX® (E)

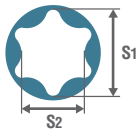

E	E4	E5	E6	E7	E8	E10	E11	E12	E14	E16	E18	E20	E22	E24	E26	E28	E30	E32
S ₁ (ref. mm)	3.7	4.6	5.6	6.1	7.4	9.3	9.9	11.0	12.8	14.6	16.5	18.3	20.1	22.0	23.7	25.5	27.3	29.0
S ₂ (ref. mm)	2.7	3.3	4.0	4.3	5.3	6.8	7.1	7.9	9.2	10.5	11.9	13.2	14.8	15.7	17.5	18.3	20.0	21.3

4425 (EPL)	D ₁ (mm)	D ₂ (mm)	H (mm)	L (mm)	(g)	(pcs.)
10EPL	13.2	21	6.2	36	45	10
12EPL	14.6	21	7.2	37	47	10
14EPL	16.5	21	8.1	37	49	10
16EPL	19	22	9.2	37	60	10
18EPL	20.3	22	10.2	37	60	10
20EPL	22.9	22	11.2	37	65	10

RS4425/6-EPL	6 Pieces Set/Rail 200mm	(g)
10EPL, 12EPL, 14EPL, 16EPL, 18EPL, 20EPL		390

4425 (EPL) TORXplus® Sockets TORXPLUS® Steckschlüssel Douilles TORXPLUS®

TORXplus®

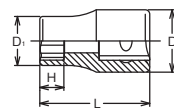

RS4425/6-EPL Socket Set on Rail Steckschlüsselsatz auf Schiene Jeu de douilles sur rail



TORXplus® (EP/EPL)

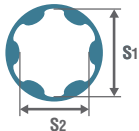

EP/EPL	8EP	10EP	12EP	14EP	16EP	18EP	20EP	22EP	24EP	26EP	28EP	30EP	32EP
S ₁ (ref. mm)	7.4	9.3	11.0	12.8	14.6	16.5	18.3	20.1	22.0	23.7	25.5	27.3	29.0
S ₂ (ref. mm)	5.7	7.1	8.5	9.8	11.2	12.7	14.0	15.4	16.8	18.2	19.6	20.9	22.3

4425 (EPRL)	D ₁ (mm)	D ₂ (mm)	H (mm)	L (mm)	(g)	(pcs.)
10EPRL	13.2	21	6.2	36	45	10
12EPRL	14.6	21	7.2	37	47	10
14EPRL	16.5	21	8.1	37	49	10
20EPRL	22.9	22	11.2	37	65	10

4425 (EPRL) Tamper-Resistant TORXPLUS® Sockets Tamper-Resistant TORXPLUS® Steckschlüssel Douilles Tamper-Resistant TORXPLUS®

TORXplus®

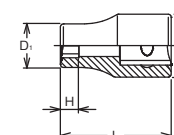

TORX® is a registered trademark of CAMCAR Innovations.
TORX® ist ein registriertes Markenzeichen der Firma CAMCAR Innovations.
TORX® est une marque déposée de CAMCAR Innovations.

TORXplus® is a registered trademark of CAMCAR Innovations.
TORXplus® ist ein registriertes Markenzeichen der Firma CAMCAR Innovations.
TORXplus® est une marque déposée de CAMCAR Innovations.

Hand Sockets Hand Steckschlüssel Douilles à main

1/2"

4400LH LHSTIX® Sockets Steckschlüssel mit LHSTIX® Profil Douilles au profil LHSTIX®

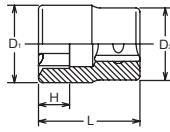

4400LH (LH-S)	D ₁ (mm)	D ₂ (mm)	H (mm)	L (mm)	(g)	(pcs.)
6S	13.2	21	5.6	36	44	10
8S	16.5	21	6.8	37	46	10
10S	19	22	8	37	53	10
12S	22.8	22	9.2	37	62	10
14S	25	24	10.4	37	74	10
16S	29	27	11.6	38	102	10

RS4400LH/6 Socket Set on Rail Steckschlüsselsatz auf Schiene Jeu de douilles sur rail



RS4400LH/6	6 Pieces Set/Rail 200mm	(g)
6S, 8S, 10S, 12S, 14S, 16S		430

LHSTIX®

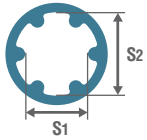

	LH-S	LH-5S	LH-6S	LH-8S	LH-10S	LH-12S	LH-14S	LH-16S
S ₁	(ref. mm)	5.6	6.8	9.0	11.3	13.6	15.8	18.1
S ₂	(ref. mm)	7.5	9.0	12.0	15.0	18.0	21.0	24.0

4450M Nut Grip Sockets **Nut Grip**® Steckschlüssel mit 2-facher Kugelhalterung Douilles à billes de retenue

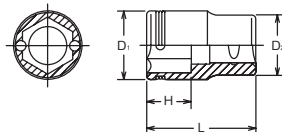

4450M (mm)	D ₁ (mm)	D ₂ (mm)	H (mm)	L (mm)	(g)	(pcs.)
10	15.3	21	6	36	44	10
11	16.5	21	6.5	36	46	10
12	17.8	21	7	36	46	10
13	19	22	8	36	52	10
14	20.3	22	8.5	36	54	10
15	21.5	22	9	36	52	10
16	22.8	22	9	36	60	10
17	24	23	9.5	36	68	10
18	25	24	10.5	36	77	10
19	26.5	25	11.5	36	85	10
21	29	27	12	37	110	10
22	30	28	12.5	37	105	10
24	32.8	30	14.5	39	130	5
27	36.5	33	16.5	40	139	5

NUT GRIP®

Twin balls at the 6-point opening hold bolt/nut tightly for safe and reliable work.

Die zwei Kugeln in der 6-kant Öffnung unserer NUT GRIP Steckschlüssel halten die Schraube sicher im Steckschlüssel. Dies erlaubt ein Arbeiten auch an schwer zugänglichen Stellen.

Les 2 billes dans l'ouverture du 6-pans de la douille retiennent l'écrou de manière sûre et efficace.

RS4450M/10 Socket Set on Rail Steckschlüsselsatz auf Schiene Jeu de douilles sur rail



RS4450M/10	10 Pieces Set/Rail 300mm	(g)
10, 11, 12, 13, 14, 15, 17, 19, 21, 22		717

Z-SERIES

HAND

TITANIUM

ACCESSORIES

SCREWDRIVERS

IMPACT

SLEEVE-DRIVE

PROTECTOR

INDUSTRIAL

AUTOMOTIVE

MOTORCYCLE

CONSTRUCTION

SPARE PART

4300M / 4300A

6-point Deep Sockets
6-kant Steckschlüssel, lang
Douilles longues, 6-pans

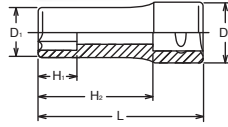

4300M 4305M (mm)	D ₁ (mm)	D ₂ (mm)	H ₁ (mm)	H ₂ (mm)	L (mm)	(g)	(pcs.)
8	13.2	21	9	59	77	76	10
9	13.8	21	10	59	77	82	10
10	15.3	21	11	59	77	82	10
11	16.5	21	12	59	77	86	10
12	17.8	21	13	59	77	92	10
13	19	21.8	14	59	77	106	10
14	20.3	21.8	15	59	77	115	10
15	21.5	21.8	16	59	77	123	10
16	22.8	22	17	59	77	141	10
17	24	23	18	59	77	139	10
18	25	24	19	59	77	149	10
19	26.5	25	20	58	77	165	10
20	27.8	26	21	58	77	183	10
21	29	27	23	58	77	190	10
22	30	28	27	57	77	200	10
23	31.5	29	27	57	77	233	10
24	32.8	30	27	57	77	249	10
25	34	31	27	57	77	270	10
26	35	32	27	56	77	279	10
27	36.5	33	28	56	77	303	10
28	37.8	34	28	56	77	331	10
29	39	35	28	55	77	357	10
30	40	36	34	55	77	342	10
31	41.5	37	34	55	77	384	10
32	42.8	38	34	55	77	405	10
33	44.2	39	35	54	77	420	5
34	45.2	40	35	54	77	442	5
35	46.2	40	35	53	77	458	5
36	47.2	41	35	53	77	484	5
37	48.2	42	38	53	77	475	5
38	49	44	38	53	77	490	5

4305M / 4305A

12-point Deep Sockets
12-kant Steckschlüssel, lang
Douilles longues, 12-pans

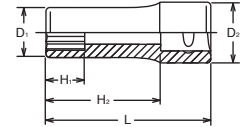
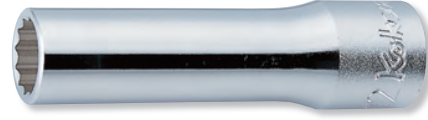

4300A 4305A (inch)	D ₁ (mm)	D ₂ (mm)	H ₁ (mm)	H ₂ (mm)	L (mm)	(g)	(pcs.)
5/16	13.2	21	9	59	77	76	10
3/8	14.6	21	10	59	77	82	10
7/16	16.5	21	12	59	77	86	10
1/2	19	21.8	14	59	77	106	10
9/16	20.3	21.8	15	59	77	115	10
19/32	21.5	21.8	16	59	77	123	10
5/8	22.8	22	17	59	77	141	10
21/32	24	23	18	59	77	139	10
11/16	25	24	19	59	77	149	10
3/4	26.5	25	20	58	77	165	10
25/32	27.8	26	21	58	77	183	10
13/16	29	27	23	58	77	190	10
7/8	30	28	27	57	77	200	10
15/16	32.8	30	27	57	77	249	10
31/32	34	31	27	57	77	270	10
1	35	32	27	56	77	279	10
1. 1/16	36.5	33	28	56	77	303	10
1. 1/8	37.8	34	28	56	77	331	10
1. 3/16	40	36	34	55	77	342	10
1. 1/4	42.8	38	34	55	77	405	10
1. 5/16	44.2	39	35	54	77	420	5
1. 3/8	46.2	40	35	54	77	422	5
1. 7/16	47.2	41	35	53	77	484	5
1. 1/2	49	44	38	53	77	523	5
1.13/16	59	48	38	51	77	791	2

RS4300M/10	10 Pieces Set/Rail 300mm	(g)
10, 11, 12, 13, 14, 15, 17, 19, 21, 22		1,415

RS4305M/10	10 Pieces Set/Rail 300mm	(g)
10, 11, 12, 13, 14, 15, 17, 19, 21, 22		1,415

RS4300M /12	12 Pieces Set/Rail 300mm	(g)
10, 12, 13, 14, 15, 16, 17, 18, 19, 20, 21, 22		1,825

RS4300A/10	10 Pieces Set/Rail 300mm	(g)
3/8, 7/16, 1/2, 9/16, 5/8, 11/16, 3/4, 13/16, 7/8, 15/16		1,600

RS4305A/10	10 Pieces Set/Rail 300mm	(g)
3/8, 7/16, 1/2, 9/16, 5/8, 11/16, 3/4, 13/16, 7/8, 15/16		1,600

RS4300M/10

Socket Set on Rail
Steckschlüsselsatz auf Schiene
Jeu de douilles sur rail



RS4300M/12

Socket Set on Rail
Steckschlüsselsatz auf Schiene
Jeu de douilles sur rail



RS4300A/10

Socket Set on Rail
Steckschlüsselsatz auf Schiene
Jeu de douilles sur rail



Hand Sockets Hand Steckschlüssel Douilles à main

1/2"

4310M Surface Drive Deep Sockets Surface Drive Steckschlüssel, lang Douilles longues, Surface Drive

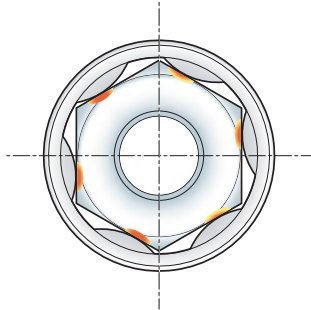
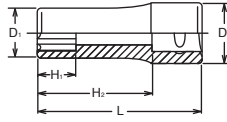

4310M (mm)	D ₁ (mm)	D ₂ (mm)	H ₁ (mm)	H ₂ (mm)	L (mm)	(g)	(pcs.)
8	13.2	21	9	59	77	79	10
9	13.8	21	10	59	77	82	10
10	15.3	21	11	59	77	82	10
11	16.5	21	12	59	77	86	10
12	17.8	21	13	59	77	92	10
13	19	21.8	14	59	77	106	10
14	20.3	21.8	15	59	77	115	10
15	21.5	21.8	16	59	77	123	10
16	22.8	22	17	59	77	141	10
17	24	23	18	59	77	139	10
18	25	24	19	59	77	149	10
19	26.5	25	20	58	77	165	10
20	27.8	26	21	58	77	183	10
21	29	27	23	58	77	190	10
22	30	28	27	57	77	200	10
23	31.5	29	27	57	77	233	10
24	32.8	30	27	57	77	249	10
25	34	31	27	57	77	270	10
26	35	32	27	56	77	279	10
27	36.5	33	28	56	77	303	10
28	37.8	34	28	56	77	334	10
29	39	35	28	55	77	357	10
30	40	36	34	55	77	342	10
31	41.5	37	34	55	77	384	10
32	42.8	38	34	55	77	405	10
34	45.2	40	35	54	77	442	5

RS4310M/10 Socket Set on Rail Steckschlüsselsatz auf Schiene Jeu de douilles sur rail



RS4310M/10	10 Pieces Set/Rail 300mm	(g)
10, 11, 12, 13, 14, 15, 17, 19, 21, 22		1,415

4325 TORX® Deep Sockets TORX® Steckschlüssel, lang Douilles longues TORX®

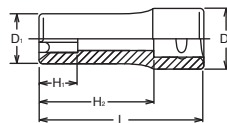

4325 (E)	D ₁ (mm)	D ₂ (mm)	H ₁ (mm)	H ₂ (mm)	L (mm)	(g)	(pcs.)
E 8	10.7	21	7	59	77	68	10
E10	13.2	21	8.2	59	77	99	10
E11	13.8	21	8.7	59	77	84	10
E12	14.6	21	9.3	59	77	99	10
E14	16.5	21	10.6	59	77	103	10
E16	19	21.8	11.8	59	77	107	10
E18	20.3	21.8	13	59	77	118	10
E20	22.8	22	14.4	59	77	141	10
E22	25	24	15.5	59	77	188	10
E24	26.6	25	17	59	77	215	10

RS4325/7 Socket Set on Rail Steckschlüsselsatz auf Schiene Jeu de douilles sur rail



RS4325/7	7 Pieces Set/Rail 200mm	(g)
E10, E12, E14, E16, E18, E20, E24		900

TORX® (E)

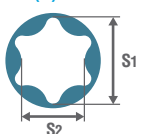

E	E4	E5	E6	E7	E8	E10	E11	E12	E14	E16	E18	E20	E22	E24	E26	E28	E30	E32
S ₁ (ref. mm)	3.7	4.6	5.6	6.1	7.4	9.3	9.9	11.0	12.8	14.6	16.5	18.3	20.1	22.0	23.7	25.5	27.3	29.0
S ₂ (ref. mm)	2.7	3.3	4.0	4.3	5.3	6.8	7.1	7.9	9.2	10.5	11.9	13.2	14.8	15.7	17.5	18.3	20.0	21.3

1/2" Hand Sockets Hand Steckschlüssel Douilles à main

4300M(L120) (mm)	D ₁ (mm)	D ₂ (mm)	H ₁ (mm)	H ₂ (mm)	L (mm)	(g)	(pcs.)
8	13.2	21	9	102	120	120	5
10	15.3	21	11	102	120	138	5
12	17.8	21	13	102	120	157	5
14	20.3	21.8	15	102	120	193	5
16	22.8	22	17	102	120	210	5

4300M (L120) 6-point Extra Deep Sockets 6-kant Steckschlüssel, extra lang Douilles extra longues 6-pans

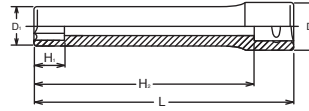

4325(L140) (E)	D ₁ (mm)	D ₂ (mm)	H ₁ (mm)	H ₂ (mm)	L (mm)	(g)	(pcs.)
E 8	10.7	21	7	122	140	110	5
E10	13.2	21	8.2	122	140	140	5
E12	14.6	21	9.3	122	140	160	5
E14	16.5	21	10.6	122	140	180	5

4325 (L140) TORX® Extra Deep Sockets TORX® Steckschlüssel, extra lang Douilles extra longues TORX®

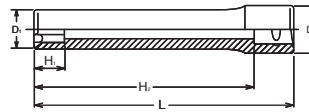

4325(L140) (E)	D ₁ (mm)	D ₂ (mm)	H ₁ (mm)	H ₂ (mm)	L (mm)	(g)	(pcs.)
E 8(2B)	10.7	21	6.6	122	140	110	5
E10(2B)	13.2	21	7.4	122	140	140	5
E12(2B)	14.6	21	9	122	140	160	5
E14(2B)	16.5	21	9.8	122	140	180	5

For Cylinder head bolt



4325 (L140)-2B

 TORX® Sockets **Nut Grip®**
TORX® Steckschlüssel mit 2-facher Kugelhalterung
Douilles TORX® à deux billes de retenue

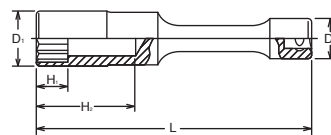
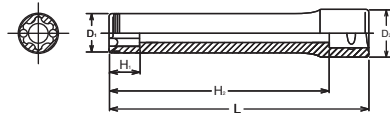

4117M-125 / -250 Extended Sockets Schäftsteckschlüssel Douilles rallongées



4117M-125 (mm)	D ₁ (mm)	D ₂ (mm)	H ₁ (mm)	H ₂ (mm)	L (mm)	(g)	(pce.)
13	18.7	24	13	59	125	213	1
14	20.2	24	14	59	125	227	1
17	24	24	17	59	125	274	1
19	26.9	24	19	59	125	279	1
21	28.5	24	21	59	125	291	1
22	30	24	22	59	125	323	1
24	32	24	24	59	125	361	1
27	36.5	24	27	59	125	439	1
30	40	24	30	59	125	461	1
32	42	24	32	59	125	498	1

4117M-250 (mm)	D ₁ (mm)	D ₂ (mm)	H ₁ (mm)	H ₂ (mm)	L (mm)	(g)	(pce.)
13	18.7	24	13	59	250	412	1
14	20.2	24	14	59	250	423	1
17	24	24	17	59	250	469	1
19	26.9	24	19	59	250	484	1
21	28.5	24	21	59	250	496	1
22	30	24	22	59	250	516	1
24	32	24	24	59	250	560	1
27	36.5	24	27	59	250	641	1
30	40	24	30	59	250	663	1
32	42	24	32	59	250	698	1

Hand Sockets Hand Steckschlüssel Douilles à main

1/2"

4440M / 4440A 6-point Universal Sockets 6-kant Gelenk-Einsätze Douilles articulées, 6-pans

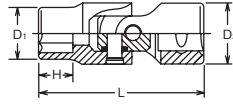

4440A (inch)	D ₁ (mm)	D ₂ (mm)	H (mm)	L (mm)	(g)	(pcs.)
3/8	14.8	25	8.8	63	155	10
7/16	16.5	25	10	65	158	10
1/2	19	25	11.4	66	152	10
9/16	20.3	25	11.4	66	151	10
5/8	22.8	25	13	68	150	10
11/16	24.6	25	14	69	153	10
3/4	26.5	25	15	71	170	10
7/8	30.3	25	16	72	185	5

4440M (mm)	D ₁ (mm)	D ₂ (mm)	H (mm)	L (mm)	(g)	(pcs.)
9	14	25	8.3	63	150	10
10	15.3	25	8.8	63	155	10
11	16.5	25	10	65	158	10
12	17.8	25	10.5	65	151	10
13	19	25	11.4	66	152	10
14	20.3	25	11.4	66	151	10
15	21.5	25	13	68	149	10
16	22.8	25	13	68	150	10
17	24	25	14	69	150	10
18	25.3	25	14	69	150	10
19	26.5	25	15	71	170	10
20	27.8	25	15	71	173	5
21	29	25	16	72	176	5
22	30.3	25	16	72	185	5

4445M / 4445A 12-point Universal Sockets 12-kant Gelenk-Einsätze Douilles articulées, 12-pans

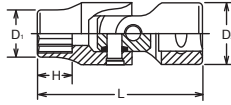

4445A (inch)	D ₁ (mm)	D ₂ (mm)	H (mm)	L (mm)	(g)	(pcs.)
3/8	14.8	25	8.8	63	155	10
7/16	16.5	25	10	65	158	10
1/2	19	25	11.4	66	152	10
9/16	20.3	25	11.4	66	151	10
5/8	22.8	25	13	68	150	10
11/16	24.6	25	14	69	153	10

4445M (mm)	D ₁ (mm)	D ₂ (mm)	H (mm)	L (mm)	(g)	(pcs.)
10	15.3	25	8.8	63	155	10
12	17.8	25	10.5	65	151	10
13	19	25	11.4	66	152	10
14	20.3	25	11.4	66	151	10
17	24	25	14	69	150	10
19	26.5	25	15	71	170	10
21	29	25	16	72	176	5
22	30.3	25	16	72	185	5

4440T TORX® Universal Sockets TORX® Gelenk-Einsätze Douilles articulées, TORX®

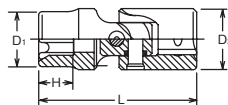

4440T (E)	D ₁ (mm)	D ₂ (mm)	H (mm)	L (mm)	(g)	(pcs.)
E10	13.2	25	8.2	62	145	10
E12	15	25	9.3	63	147	10
E14	16.3	25	10.6	65	148	10
E16	18.8	25	11.8	65	150	10
E18	20.4	25	13	67	153	10

4000-60 (PH) PH Bit Sockets Steckschlüssel für Kreuzschlitzschrauben, PH Douilles tournevis pour vis à empreinte PH

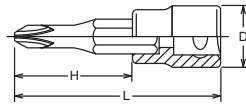

4000 (PH)	D (mm)	H (mm)	L (mm)	(g)	(pcs.)
2	22	23.5	60	65	10
3	22	23.5	60	65	10
4	22	23.5	60	67	10

4000-60 (PZ) PZ Bit Sockets Steckschlüssel für Kreuzschlitzschrauben, PZ Douilles tournevis pour vis à empreinte PZ

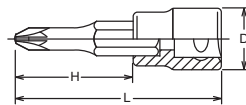

4000-60 (PZ)	D (mm)	H (mm)	L (mm)	(g)	(pcs.)
PZ2	22	23.5	60	65	10
PZ3	22	23.5	60	65	10

4005-60 Bit Sockets for Slotted Heads Steckschlüssel für Schlitzschrauben Douilles tournevis pour vis à fente

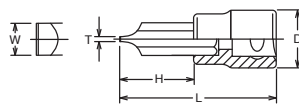



4005	TxW (mm)	D (mm)	H (mm)	L (mm)	(g)	(pcs.)
8	1.2x 8	22	23.5	60	65	10
10	1.6x10	22	23.5	60	75	10
12	2.0x12	23	23.5	60	111	10
14	2.5x14	24	23.5	60	133	10
16	2.5x16	24	23.5	60	133	10

TORX® is a registered trademark of CAMCAR Innovations.
TORX® ist ein registriertes Markenzeichen der Firma CAMCAR Innovations.
TORX® est une marque déposée de CAMCAR Innovations.

1/2" Hand Sockets Hand Steckschlüssel Douilles à main

4010M-50 / -75 / -100 / -160 4010A-60

 Inhex Bit Sockets
 Steckschlüssel für Innensechskant-Schrauben
 Douilles tournevis pour vis 6-pans creux

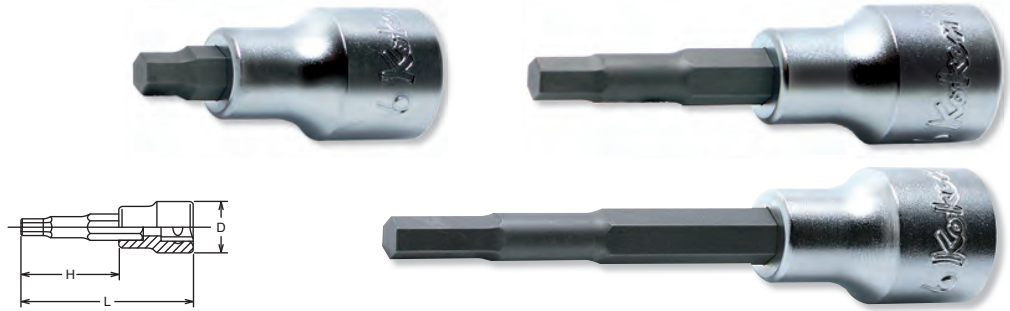

4010M-50 (mm)	D (mm)	H (mm)	L (mm)	(g)	(pcs.)
4	22	13.5	50	61	10
5	22	13.5	50	62	10
6	22	13.5	50	64	10
7	22	13.5	50	65	10
8	22	13.5	50	66	10
9	22	13.5	50	73	10
10	22	13.5	50	75	10
12	23	13.5	50	105	10
13	24	13.5	50	120	10
14	24	13.5	50	120	10
16	25	15	50	150	10
17	25	15	50	150	10
18	27	15	50	200	5
19	27	15	50	200	5

4010M-75 (mm)	D (mm)	H (mm)	L (mm)	(g)	(pcs.)
4	22	38.5	75	69	10
5	22	38.5	75	70	10
6	22	38.5	75	72	10
7	22	38.5	75	73	10
8	22	38.5	75	74	10
9	22	38.5	75	90	10
10	22	38.5	75	92	10
12	23	38.5	75	130	10
13	24	38.5	75	150	10
14	24	38.5	75	150	10
16	25	35	75	180	10
17	25	35	75	180	10
18	27	33	75	230	5
19	27	33	75	230	5



4010M-100 (mm)	D (mm)	H (mm)	L (mm)	(g)	(pcs.)
4	22	63.5	100	77	10
5	22	63.5	100	78	10
6	22	63.5	100	80	10
7	22	63.5	100	82	10
8	22	63.5	100	84	10
9	22	63.5	100	105	10
10	22	63.5	100	109	10
12	23	63.5	100	155	10
13	24	63.5	100	180	5
14	24	63.5	100	180	5
16	25	60	100	250	5
17	25	60	100	250	5
18	27	58	100	300	5
19	27	58	100	300	5

4010M-160 (mm)	D (mm)	H (mm)	L (mm)	(g)	(pcs.)
4	22	123.5	160	103	10
5	22	123.5	160	104	10
6	22	123.5	160	106	10
7	22	123.5	160	108	10
8	22	123.5	160	110	10
10	22	123.5	160	126	10
12	23	123.5	160	180	5
14	24	123.5	160	260	5
17	25	120	160	360	5
19	27	118	160	415	5

4010A-60 (inch)	D (mm)	H (mm)	L (mm)	(g)	(pcs.)
5/32	22	23.5	60	57	10
3/16	22	23.5	60	57	10
7/32	22	23.5	60	59	10
1/4	22	23.5	60	63	10
9/32	22	23.5	60	65	10
5/16	22	23.5	60	67	10
11/32	22	23.5	60	75	10
3/8	22	23.5	60	76	10
7/16	23	23.5	60	101	10
1/2	24	23.5	60	124	10
9/16	25	20	60	127	10
5/8	25	20	60	174	10
3/4	27	18	60	220	5



RS4010M/10-L50	10 Pieces Set/Rail 300mm	(g)
4, 5, 6, 7, 8, 10, 12, 14, 17, 19		968
RS4010M/10-L75	10 Pieces Set/Rail 300mm	(g)
4, 5, 6, 7, 8, 10, 12, 14, 17, 19		1,207
RS4010A/10-L60	10 Pieces Set/Rail 300mm	(g)
3/16, 7/32, 1/4, 5/16, 3/8, 7/16, 1/2, 9/16, 5/8, 3/4		1,080



RS4010M/10-L50  Socket Set on Rail
RS4010M/10-L75  Steckschlüsselsatz auf Schiene
RS4010A/10-L60  Jeu de douilles sur rail



Hand Sockets Hand Steckschlüssel Douilles à main

1/2"

4012M-43 / -60 / -75 / -100

 Inhex Sockets
Steckschlüssel für Innensechskant-Schrauben 
Douilles tournevis pour vis 6-pans creux

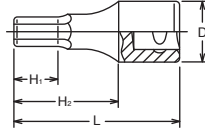

4012M-43 (mm)	D (mm)	H ₁ (mm)	H ₂ (mm)	L (mm)	(g)	(pcs.)
4	21.1	11.5	23	43	40	10
5	21.1	11.5	23	43	46	10
6	21.1	11.5	23	43	42	10
7	21.1	11.5	23	43	46	10
8	21.1	11.5	23	43	49	10
9	21.1	11.5	23	43	63	10
10	23	11.5	23	43	63	10
11	25	11.5	23	43	74	10
12	25	11.5	23	43	81	10
13	25	11.5	23	43	85	10
14	25	11.5	23	43	88	10
15	26	11.5	23	43	91	10
16	26	11.5	23	43	100	10
17	26	11.5	23	43	101	10
18	26	11.5	23	43	106	10
19	26	11.5	23	43	110	10
20	26	11.5	23	43	130	10
21	26	11.5	23	43	140	10
22	26	11.5	23	43	145	10
23	28	11.5	23	43	167	10
24	28	11.5	23	43	170	10
27	32	11.5	23	43	226	10

4012M-60 (mm)	D (mm)	H ₁ (mm)	H ₂ (mm)	L (mm)	(g)	(pcs.)
4	21.1	15.5	38	60	49	10
5	21.1	15.5	38	60	55	10
6	21.1	15.5	38	60	56	10
7	21.1	15.5	38	60	60	10
8	21.1	15.5	38	60	64	10
9	21.1	15.5	38	60	78	10
10	23	15.5	38	60	78	10
11	25	15.5	38	60	100	10
12	25	15.5	38	60	107	10
13	25	15.5	38	60	111	10
14	25	15.5	38	60	122	10
15	26	15.5	38	60	125	10
16	26	15.5	38	60	134	10
17	26	15.5	38	60	141	10
18	26	15.5	38	60	153	10
19	26	15.5	38	60	159	10
21	26	15.5	38	60	197	10
22	26	22.5	38	60	205	10
23	28	22.5	38	60	242	10
24	28	22.5	38	60	245	10

4012M-75 (mm)	D (mm)	H ₁ (mm)	H ₂ (mm)	L (mm)	(g)	(pcs.)
4	21.1	15.5	53	75	52	10
5	21.1	15.5	53	75	58	10
6	21.1	15.5	53	75	62	10
7	21.1	15.5	53	75	70	10
8	21.1	15.5	53	75	74	10
9	21.1	15.5	53	75	88	10
10	23	15.5	53	75	94	10
11	25	15.5	53	75	119	10
12	25	15.5	53	75	122	10
13	25	15.5	53	75	137	10
14	25	15.5	53	75	148	10
15	26	15.5	53	75	151	10
16	26	15.5	53	75	171	10
17	26	15.5	53	75	184	10
18	26	15.5	53	75	196	10
19	26	15.5	53	75	212	10
22	26	22.5	53	75	266	10
24	27.9	22.5	53	75	315	10

4012M-100 (mm)	D (mm)	H ₁ (mm)	H ₂ (mm)	L (mm)	(g)	(pcs.)
4	24	15.5	78	100	75	10
5	24	15.5	78	100	81	10
6	24	15.5	78	100	85	10
7	24	15.5	78	100	93	10
8	24	15.5	78	100	97	10
9	24	15.5	78	100	111	10
10	24	15.5	78	100	117	10
11	24	15.5	78	100	142	10
12	24	15.5	78	100	143	10
13	24	15.5	78	100	158	10
14	24	15.5	78	100	169	10
15	24	15.5	78	100	172	10
16	24	15.5	78	100	192	5
17	24	15.5	78	100	215	5
18	24	15.5	78	100	227	5
19	24	15.5	78	100	243	5

RS4012M/10-L60



 Socket Set on Rail
Steckschlüsselsatz auf Schiene
Jeu de douilles sur rail



RS4012M/10-L60	10 Pieces set/Rail 300mm	(g)
4, 5, 6, 7, 8, 10, 12, 14, 17, 19		910

 4012M/A are for hand use only.
Do not use with a power or impact wrench.
Nicht auf Maschinenschrauben verwenden.
À ne pas utiliser sur des machines

4012A-43 / -60 / -75 / -100

 Inhex Sockets
Steckschlüssel für Innensechskant-Schrauben 
Douilles tournevis pour vis 6-pans creux

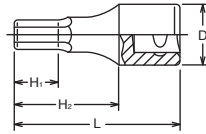

4012A-43 (inch)	D (mm)	H ₁ (mm)	H ₂ (mm)	L (mm)	(g)	(pcs.)
5/32	21.1	11.5	23	43	40	10
3/16	21.1	11.5	23	43	46	10
7/32	21.1	11.5	23	43	42	10
1/4	21.1	11.5	23	43	43	10
9/32	21.1	11.5	23	43	46	10
5/16	21.1	11.5	23	43	49	10
11/32	21.1	11.5	23	43	63	10
3/8	23	11.5	23	43	59	10
7/16	25	11.5	23	43	74	10
1/2	25	11.5	23	43	85	10
9/16	25	11.5	23	43	88	10
5/8	26	11.5	23	43	100	10
3/4	26	11.5	23	43	110	10
7/8	26	11.5	23	43	141	10

4012A-60 (inch)	D (mm)	H ₁ (mm)	H ₂ (mm)	L (mm)	(g)	(pcs.)
5/32	21.1	15.5	38	60	49	10
3/16	21.1	15.5	38	60	55	10
7/32	21.1	15.5	38	60	56	10
1/4	21.1	15.5	38	60	57	10
9/32	21.1	15.5	38	60	60	10
5/16	21.1	15.5	38	60	64	10
11/32	21.1	15.5	38	60	78	10
3/8	23	15.5	38	60	74	10
7/16	25	15.5	38	60	100	10
1/2	25	15.5	38	60	111	10
9/16	25	15.5	38	60	122	10
5/8	26	15.5	38	60	134	10
3/4	26	15.5	38	60	159	10
7/8	26	22.5	38	60	202	10

4012A-75 (inch)	D (mm)	H ₁ (mm)	H ₂ (mm)	L (mm)	(g)	(pcs.)
5/32	21.1	15.5	53	75	52	10
3/16	21.1	15.5	53	75	58	10
7/32	21.1	15.5	53	75	62	10
1/4	21.1	15.5	53	75	65	10
9/32	21.1	15.5	53	75	70	10
5/16	21.1	15.5	53	75	74	10
11/32	21.1	15.5	53	75	88	10
3/8	23	15.5	53	75	86	10
7/16	25	15.5	53	75	119	10
1/2	25	15.5	53	75	137	10
9/16	25	15.5	53	75	148	10
5/8	26	15.5	53	75	171	10
3/4	26	15.5	53	75	212	10
7/8	26	22.5	53	75	262	10

4012A-100 (inch)	D (mm)	H ₁ (mm)	H ₂ (mm)	L (mm)	(g)	(pcs.)
5/32	24	15.5	78	100	75	10
3/16	24	15.5	78	100	81	10
7/32	24	15.5	78	100	85	10
1/4	24	15.5	78	100	88	10
9/32	24	15.5	78	100	93	10
5/16	24	15.5	78	100	97	10
11/32	24	15.5	78	100	111	10
3/8	24	15.5	78	100	109	10
7/16	24	15.5	78	100	142	10
1/2	24	15.5	78	100	158	10
9/16	24	15.5	78	100	169	10
5/8	24	15.5	78	100	192	5
3/4	24	15.5	78	100	243	5

RS4012A/10-L60	10 Pieces set/Rail 300mm	(g)
3/16, 7/32, 1/4, 5/16, 3/8, 7/16, 1/2, 9/16, 5/8, 3/4		950

RS4012A/10-L60



Socket Set on Rail
Steckschlüsselsatz auf Schiene
Jeu de douilles sur rail



 4012MA are for hand use only.
Do not use with a power or impact wrench.
Nicht auf Maschinenschraubern verwenden.
À ne pas utiliser sur des machines

4020-60 / -100 / -120 / -140

 XZN Bit Sockets
Steckschlüssel für XZN Schrauben
Douilles tournevis pour empreinte XZN

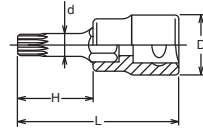
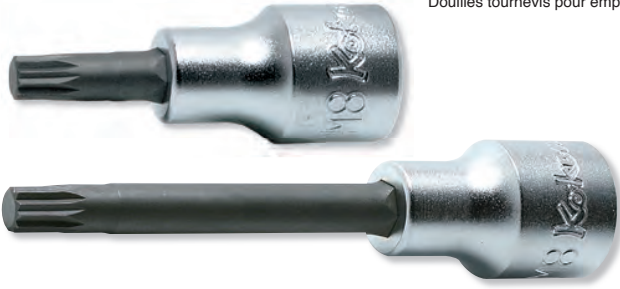

4020-60 (XZN)	D (mm)	d (mm)	H (mm)	L (mm)	(g)	(pcs.)
M 5	22	7.8	23.5	60	60	10
M 6	22	7.8	23.5	60	61	10
M 8	22	7.8	23.5	60	63	10
M10	23	11.9	23.5	60	93	10
M12	23	11.9	23.5	60	97	10
M14	24	13.9	23.5	60	105	10
M16	25	16.9	20	60	165	10
M18	25	17.9	20	60	170	10

4020-100 (XZN)	D (mm)	d (mm)	H (mm)	L (mm)	(g)	(pcs.)
M 5	22	7.8	63.5	100	77	10
M 6	22	7.8	63.5	100	78	10
M 8	22	7.8	63.5	100	80	10
M10	23	11.9	63.5	100	132	10
M12	23	11.9	63.5	100	136	10
M14	24	13.9	63.5	100	144	5
M16	25	16.9	60	100	250	5
M18	27	17.9	60	100	300	5

4020-120 (XZN)	D (mm)	d (mm)	H (mm)	L (mm)	(g)	(pcs.)
M 5	22	7.8	83.5	120	86	10
M 6	22	7.8	83.5	120	87	10
M 8	22	7.8	83.5	120	89	10
M10	23	11.9	83.5	120	152	10
M12	23	11.9	83.5	120	156	10
M14	24	13.9	83.5	120	164	5

4020-140 (XZN)	D (mm)	d (mm)	H (mm)	L (mm)	(g)	(pcs.)
M 5	22	7.8	103.5	140	95	10
M 6	22	7.8	103.5	140	96	10
M 8	22	7.8	103.5	140	98	10
M10	23	11.9	103.5	140	172	5
M12	23	11.9	103.5	140	176	5
M14	24	13.9	103.5	140	184	5

RS4020/6-L60 RS4020/6-L100

 Socket Set on Rail
Steckschlüsselsatz auf Schiene
Jeu de douilles sur rail









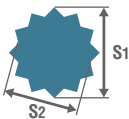



RS4020/6-L60	6 Pieces Set/Rail 150mm	(g)
M5, M6, M8, M10, M12, M14		500

RS4020/6-L100	6 Pieces Set/Rail 150mm	(g)
M5, M6, M8, M10, M12, M14		680

XZN



XZN		M4	M5	M6	M8	M10	M12	M14	M16	M18
S ₁	(ref. mm)	3.6	4.8	6.1	7.3	9.7	11.5	13.3	15.7	16.9
S ₂	(ref. mm)	3.1	4.1	5.1	6.1	8.1	9.7	11.2	13.2	14.2

	 PH	 PZ	 Slotted	 HEX	 HEX (ball point)	 Triple Square (XZN)	 TORX® (T)	 TORX® (TH)	 TORXplus® (IP)	 TORXplus® (IPR)	 Ribe-CV
1/4"	No.2000 series	No.2000(PZ) series	No.2005 series	No.2010M/A series	No.2011M series	No.2020 series	No.2025 series	No.2025(TH) series	No.2025(IP) series	No.2025(IPR) series	—
3/8"	No.3000 series	No.3000(PZ) series	No.3005 series	No.3010M/A No.3012M/A No.3015M series	No.3011M series	No.3020 series	No.3025 series	No.3025(TH) series	No.3025(IP) series	No.3025(IPR) series	No.3027 series
1/2"	No.4000 series	No.4000(PZ) series	No.4005 series	No.4010M/A No.4012M/A series	—	No.4020 series	No.4025 series	—	No.4025(IP) series	—	No.4027 series

1/2" Hand Sockets Hand Steckschlüssel Douilles à main

Z-SERIES
HAND
TITANIUM
ACCESSORIES
SCREWDRIVERS
IMPACT
SLEEVE-DRIVE
PROTECTOR
INDUSTRIAL
AUTOMOTIVE
MOTORCYCLE
CONSTRUCTION
SPARE PART

4025-60 (T)	D (mm)	H (mm)	L (mm)	(g)	(pcs.)
T15	22	23.5	60	58	10
T20	22	23.5	60	59	10
T25	22	23.5	60	60	10
T27	22	23.5	60	60	10
T30	22	23.5	60	60	10
T40	22	23.5	60	62	10
T45	22	23.5	60	64	10
T50	22	23.5	60	74	10
T55	23	23.5	60	96	10
T60	24	23.5	60	122	10
T70	24	23.5	60	135	10
T80	24	20	60	168	10

4025-100 (T)	D (mm)	H (mm)	L (mm)	(g)	(pcs.)
T20	22	73.5	100	76	10
T25	22	73.5	100	76	10
T27	22	73.5	100	77	10
T30	22	73.5	100	77	10
T40	22	73.5	100	78	10
T45	22	73.5	100	80	10
T50	22	73.5	100	98	10
T55	23	73.5	100	132	10
T60	24	73.5	100	170	5
T70	24	73.5	100	175	5

4025-140 (T)	D (mm)	H (mm)	L (mm)	(g)	(pcs.)
T20	22	103.5	140	94	10
T25	22	103.5	140	95	10
T27	22	103.5	140	95	10
T30	22	103.5	140	95	10
T40	22	103.5	140	97	10
T45	22	103.5	140	99	10
T50	22	103.5	140	129	10
T55	23	103.5	140	175	5
T60	24	103.5	140	229	5
T70	24	103.5	140	245	5
T80	24	100	140	320	5

RS4025/9-L60	9 Pieces Set/Rail 250mm	(g)
T20, T25, T27, T30, T40, T45, T50, T55, T60		700

4025-60 / -100 / -140 (T)

TORX® Bit Sockets
TORX® Bit-Steckschlüssel
Douilles tournevis, TORX®

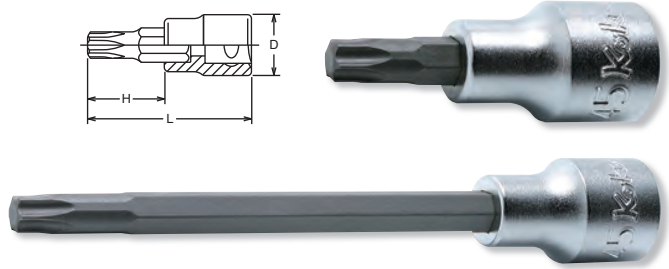

RS4025/9-L60



Socket Set on Rail
Steckschlüsselsatz auf Schiene
Jeu de douilles sur rail



TORX®
(T)

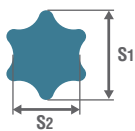

T	T8	T9	T10	T15	T20	T25	T27	T30	T40	T45	T50	T55	T60	T70	T80	T90	T100
S ₁ (ref. mm)	2.3	2.5	2.7	3.3	3.9	4.5	5.0	5.6	6.7	7.9	8.9	11.3	13.3	15.6	17.6	20.0	22.2
S ₂ (ref. mm)	1.7	1.8	2.0	2.3	2.8	3.2	3.6	4.0	4.8	5.6	6.2	8.0	9.5	11.1	12.7	14.2	15.8

4025-60	D (mm)	H (mm)	L (mm)	(g)	(pcs.)
T35	22	23.5	60	96	10

For T35 Special screws

4025-60-T35

Bit Socket
Bit-Steckschlüssel
Douille tournevis



4025-60 / -100 (IP)

TORXPLUS® Bit Sockets
TORXPLUS® Bit-Steckschlüssel
Douilles tournevis, TORXPLUS®

TORXplus®



4025-60 (IP)	D (mm)	H (mm)	L (mm)	(g)	(pcs.)
20IP	22	23.5	60	60	10
25IP	22	23.5	60	60	10
27IP	22	23.5	60	60	10
30IP	22	23.5	60	60	10
40IP	22	23.5	60	60	10
45IP	22	23.5	60	64	10
50IP	22	23.5	60	74	10
55IP	23	23.5	60	96	10
60IP	24	23.5	60	122	10
70IP	24	23.5	60	170	10

RS4025/9-IP

Socket Set on Rail
Steckschlüsselsatz auf Schiene
Jeu de douilles sur rail



4025-100 (IP)	D (mm)	H (mm)	L (mm)	(g)	(pcs.)
40IP	22	63.5	100	79	10
45IP	22	63.5	100	81	10
50IP	22	63.5	100	100	10
55IP	23	63.5	100	133	10
60IP	24	63.5	100	172	5
70IP	25	63.5	100	241	5

RS4025/9-IP	9 Pieces set/Rail 250mm	(g)
20IP, 25IP, 27IP, 30IP, 40IP, 45IP, 50IP, 55IP, 60IP		700

TORXPLUS®
(IP)

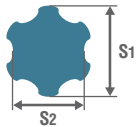

IP	8IP	9IP	10IP	15IP	20IP	25IP	27IP	30IP	40IP	45IP	50IP	55IP	60IP	70IP	
S ₁	(ref. mm)	2.3	2.5	2.7	3.3	3.9	4.5	5.0	5.6	6.7	7.9	8.9	11.3	13.3	15.6
S ₂	(ref. mm)	1.8	1.9	2.1	2.5	3.0	3.4	3.9	4.3	5.2	6.2	6.9	9.0	10.4	12.3

4027-60 / -100 / -140

Bit Sockets for Ribe Screws
Steckschlüsselklingen für Ribe Schrauben
Douilles tournevis pour écrous profil Ribe

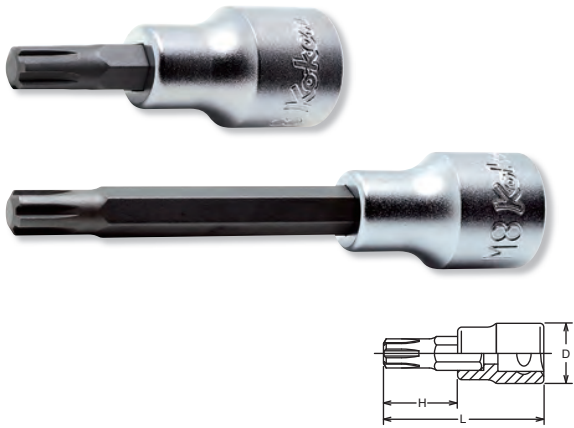

4027-60	D (mm)	H (mm)	L (mm)	(g)	(pcs.)
M 5	22	23.5	60	60	10
M 6	22	23.5	60	62	10
M 7	22	23.5	60	63	10
M 8	22	23.5	60	64	10
M 9	22	23.5	60	70	10
M10	22	23.5	60	74	10
M12	23	23.5	60	96	10
M13	24	23.5	60	116	10
M14	24	23.5	60	122	10
M16	24	25	60	135	10

4027-100	D (mm)	H (mm)	L (mm)	(g)	(pcs.)
M 5	22	63.5	100	67	10
M 6	22	63.5	100	68	10
M 7	22	63.5	100	75	10
M 8	22	63.5	100	81	10
M 9	22	63.5	100	90	10
M10	22	63.5	100	101	10
M12	23	63.5	100	134	10
M13	24	63.5	100	155	5
M14	24	63.5	100	173	5
M16	24	60	100	241	5

4027-140	D (mm)	H (mm)	L (mm)	(g)	(pcs.)
M 8	22	103.5	140	98	10
M10	22	103.5	140	127	10
M12	23	103.5	140	171	5
M14	24	103.5	140	226	5
M16	24	100	140	320	5

RS4027/7-L60	7 Pieces set/Rail 200mm	(g)
M5, M6, M8, M10, M12, M14, M16		600

RS4027/7-L60

Socket Set on Rail
Steckschlüsselsatz auf Schiene
Jeu de douilles sur rail



Ribe CV

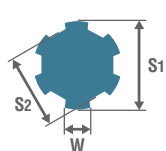

CV	M5	M6	M7	M8	M9	M10	M12	M13	M14	M16
W	(ref. mm)	1.2	1.3	1.4	1.8	2.0	2.3	2.6	3.1	3.6
S ₁	(ref. mm)	5.0	6.0	7.0	8.0	9.0	10.0	12.0	13.0	16.0
S ₂	(ref. mm)	3.8	4.5	5.0	6.0	7.1	7.4	9.0	11.0	11.9

4110M (mm)	D (mm)	H (mm)	L (mm)	(g)	(pcs.)
8	24	10	32	57	10
10	24	10	32	62	10
10.5	24	10	32	64	10
12	24	10	32	64	10
13	24	10	32	66	10
13.5	24	10	32	67	10
14	24.2	10	32	68	10
19	25	15	37	101	10
20	26	15	37	114	10

4110A (inch)	D (mm)	H (mm)	L (mm)	(g)	(pcs.)
3/8	24	10	32	62	10
1/2	24	10	32	64	10

4101	TxW (mm)	D (mm)	L (mm)	(g)	(pcs.)
1	2.7x18.6	22	40	59	10
2	3.7x24	24	40	79	10
3	3.7x30	30	40	128	10

4137	D ₁ (mm)	D ₂ (mm)	L (mm)	(g)	(pcs.)
4137	13	22	38	53	10

For DIN3126 C6.3 Bits
Für DIN3126 C6.3 Bits
Pour DIN3126 C6.3 Embouts

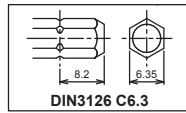

4138	D ₁ (mm)	D ₂ (mm)	L (mm)	(g)	(pcs.)
4138	16	22	38	62	10

For DIN3126 C8 Bits
Für DIN3126 C8 Bits
Pour DIN3126 C8 Embouts

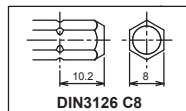

4110M / 4110A

4-point Male Sockets
Öldienst-Steckschlüssel, Vierkant
Douilles mâles 4-pans

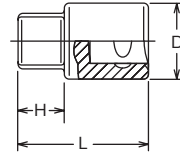

4101

Sockets for Slotted Heads
Steckschlüssel für Schlitzschrauben
Douilles tournevis pour vis à fente

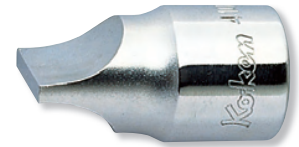
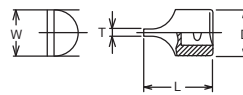

4137

Bit Holder
Klingenhalter
Porte-embouts

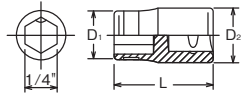

4138

Bit Holder
Klingenhalter
Porte-embouts

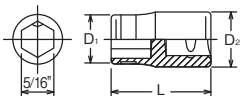

Hand Sockets Hand Steckschlüssel Douilles à main

1/2"

3749S-1/2 Reversible Ratchet Short
Knarre, verstellbar
Cliquet, réversible



* Renewal Kits → 3749SRK-1/2 → P318

3749SB-1/2 Reversible Ratchet short with quick release button
Knarre, verstellbar mit Entriegelungsknopf
Cliquet, réversible avec bouton de débrayage

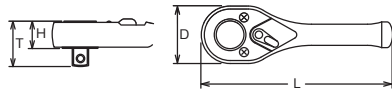

* Renewal Kits → 3749SBRK-1/2 → P318

	D (mm)	T (mm)	H (mm)	L (mm)	(g)	(pcs.)
3749S-1/2	34	29	14.4	110	200	5
3749SB-1/2	34	29	14.4	110	200	5

⚠ Reversible Ratchet with quick release button has less strength compared with normal ratchet due to the technical design. Make sure to use the ratchet correctly.

Die Umschaltknarre mit Entriegelungsknopf hat aufgrund der technischen Konstruktion eine geringere Festigkeit als eine normale Ratsche. Stellen Sie sicher, dass Sie die Ratsche richtig verwenden.

Le cliquet réversible avec bouton de libération rapide a une résistance moindre que le cliquet normal en raison de sa conception technique. Veuillez à utiliser le cliquet correctement.

4752J Reversible Ratchet
Knarre, verstellbar
Cliquet, réversible



* Renewal Kits → 4752RK → P319

[L/R Marking]



4752N Reversible Ratchet
Knarre, verstellbar
Cliquet, réversible

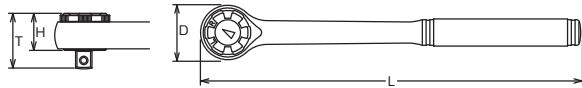

A pointer and L/R markings on the ratchet head indicate the turning direction. The reduced diameter of the head allows easier access in tight spots.

Eine L/R Markierung auf dem Knarrenkopf zeigt die gerade eingestellte Drehrichtung an. Der geringe Kopfdurchmesser erleichtert das Arbeiten auch an schwer zugänglichen Stellen.

Un marquage L/R sur la tête de cliquet indique le sens de rotation. Le diamètre de tête réduit et facilite le travail dans les endroits difficilement accessibles.

	D (mm)	T (mm)	H (mm)	L (mm)	(g)	(pcs.)
4752J	35	38.8	24.5	250	470	1
4752N	35	38.8	24.5	250	480	1

GEAR TEETH



4749series



4753series



4750series



4752series



4774series



1/2" Hand Sockets Hand Steckschlüssel Douilles à main



4750J Reversible Ratchet
Knarre, verstellbar
Cliquet, réversible



4750P Reversible Ratchet
Knarre, verstellbar
Cliquet, réversible



4750N Reversible Ratchet
Knarre, verstellbar
Cliquet, réversible



	D (mm)	T (mm)	H (mm)	L (mm)	(g)	(pce.)
4750J	38	35.9	21.3	250	508	1
4750P	38	35.9	21.3	250	553	1
4750N	38	35.9	21.3	250	548	1

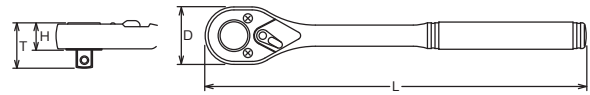

4750JB Reversible Ratchet with quick release button
4750PB Knarre, verstellbar mit Entriegelungsknopf
4750NB Cliquet, réversible avec bouton de débrayage



	D (mm)	T (mm)	H (mm)	L (mm)	(g)	(pce.)
4750JB	38	35.9	21.3	250	508	1
4750PB	38	35.9	21.3	250	553	1
4750NB	38	35.9	21.3	250	548	1

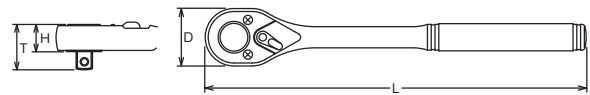

⚠ Reversible Ratchet with quick release button has less strength compared with normal ratchet due to the technical design. Make sure to use the ratchet correctly.

Die Umschaltknarre mit Entriegelungsknopf hat aufgrund der technischen Konstruktion eine geringere Festigkeit als eine normale Ratsche. Stellen Sie sicher, dass Sie die Ratsche richtig verwenden.

Le cliquet réversible avec bouton de libération rapide a une résistance moindre que le cliquet normal en raison de sa conception technique. Veuillez à utiliser le cliquet correctement.



[4750 series]

Two dogs are set in the same axis and the three teeth hold the ratchet gear. The enlarged contact area produces an about 10% higher torque value and the S.O.D.H system provides smooth and light movements.

Die scharnierartig eingelagerten Sperrklinken haben jetzt jeweils drei Zähne im Eingriff. Die dadurch vergrößerte Greiffläche erhöht das maximale Drehmoment um ca. 10%. Auch diese Knarre besticht durch ihren leichten und geschmeidigen Lauf.

Les deux rochets étant placés sur le même axe, les trois dents de l'engrenage sont engagées en permanence. Ce système assure une augmentation de 10% du couple maximum admissible. Ce cliquet se caractérise également par son fonctionnement souple et sans à-coup.

Hand Sockets Hand Steckschlüssel Douilles à main

1/2"

4753J Reversible Ratchet
Knarre, verstellbar
Cliquet, réversible



4753P Reversible Ratchet
Knarre, verstellbar
Cliquet, réversible



4753N Reversible Ratchet
Knarre, verstellbar
Cliquet, réversible



D4753J Reversible Ratchet
Knarre, verstellbar
Cliquet, réversible

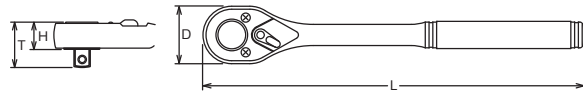

Special ratchet, surface phosphatised, no chrome flaking possible
Sonderknarre Oberfläche phosphatiert, keine Chromabplatzungen möglich
Cliquet spécial surface phosphatée, pas d'écaillage du chrome possible

	D (mm)	T (mm)	H (mm)	L (mm)	(g)	(pce.)
4753J	38	36.2	21.6	250	545	1
4753P	38	36.2	21.6	250	570	1
4753N	38	36.2	21.6	250	595	1
D4753J	38	36.2	21.6	250	510	1

4753JB Reversible Ratchet with quick release button
Knarre, verstellbar mit Entriegelungsknopf

4753PB

4753NB

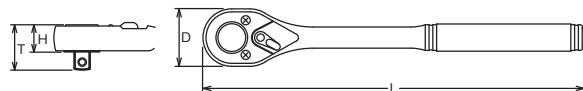

Reversible Ratchet with Quick Release Button :

Sockets and accessories are safely locked. By pushing the button the sockets or extension bars are released from the ratchet.

Umstellbare Knarre mit Entriegelungsknopf :

Steckschlüssel und Zubehörteile werden sicher und fest gehalten. Bei Drücken des Knopfes lösen sich die Teile.

Cliquet réversible avec bouton de débrayage :

Les douilles et accessoires ne peuvent plus tomber. Une pression du pouce sur le bouton suffit pour les libérer.



⚠ Reversible Ratchet with quick release button has less strength compared with normal ratchet due to the technical design. Make sure to use the ratchet correctly.

Die Umschaltknarre mit Entriegelungsknopf hat aufgrund der technischen Konstruktion eine geringere Festigkeit als eine normale Ratsche. Stellen Sie sicher, dass Sie die Ratsche richtig verwenden.

Le cliquet réversible avec bouton de libération rapide a une résistance moindre que le cliquet normal en raison de sa conception technique. Veuillez à utiliser le cliquet correctement.

	D (mm)	T (mm)	H (mm)	L (mm)	(g)	(pce.)
4753JB	38	36.2	21.6	250	545	1
4753PB	38	36.2	21.6	250	570	1
4753NB	38	36.2	21.6	250	595	1

Z-SERIES

HAND

TITANIUM

SCREWDRIVERS ACCESSORIES

IMPACT

SLEEVE-DRIVE

PROTECTOR

INDUSTRIAL

AUTOMOTIVE

MOTORCYCLE

CONSTRUCTION

SPARE PART

1/2"

Hand Sockets Hand Steckschlüssel Douilles à main

Z-SERIES
HAND
TITANIUM
ACCESSORIES
SCREWDRIVERS
IMPACT
SLEEVE-DRIVE
PROTECTOR
INDUSTRIAL
AUTOMOTIVE
MOTORCYCLE
CONSTRUCTION
SPARE PART



* Renewal Kits → 4749RK → P318

4749J-380
4749N-380

Reversible Ratchet (long)
Verstellbare Knarre, lang
Cliquet réversible, long



	D (mm)	T (mm)	H (mm)	L (mm)	(g)	(pce.)
4749J-380	44.6	33	18.4	380	743	1
4749N-380	44.6	33	18.4	380	753	1

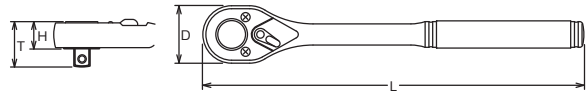

* Renewal Kits → 4753RK → P318

4753P-410

Reversible Ratchet (long)
Verstellbare Knarre, lang
Cliquet réversible, long



	D (mm)	T (mm)	H (mm)	L (mm)	(g)	(pce.)
4753P-410	38	36.2	21.6	410	790	1

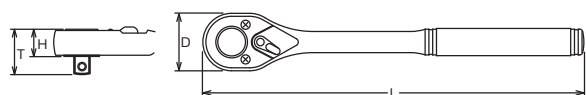

⚠ 4753P-410 have longer handle than standard, and can be loaded to excessive torque value. In the interest of your own safety always apply load evenly and progressively to avoid breakage and possible injury.



* Renewal Kits → 4753RK → P318

4774J
4774P
4774N

Flexible Ratchet, reversible
Gelenk-Knarre, verstellbar
Cliquet articulé, réversible



	D (mm)	T (mm)	H (mm)	L (mm)	(g)	(pce.)
4774J	38	36.2	21.6	330	685	1
4774P	38	36.2	21.6	330	700	1
4774N	38	36.2	21.6	330	700	1

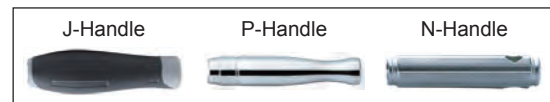
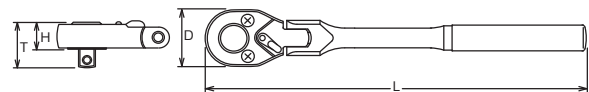

* Renewal Kits → 4753RK → P318

4774P-450

Flexible Ratchet (long), reversible
Gelenk-Knarre lang, verstellbar
Cliquet articulé long, réversible



	D (mm)	T (mm)	H (mm)	L (mm)	(g)	(pce.)
4774P-450	38	36.2	21.6	450	790	1

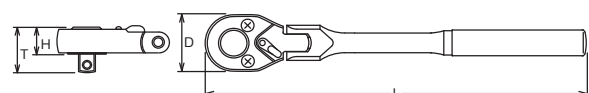

⚠ 4774P-450 has longer handle than standard, and can be loaded to excessive torque value. In the interest of your own safety always apply load evenly and progressively to avoid breakage and possible injury.

Hand Sockets
Hand Steckschlüssel
Douilles à main

1/2"

4774JB
4774PB
4774NB

Flexible Ratchet, reversible with quick release button
Gelenk-Knarre, verstellbar mit Entriegelungsknopf
Cliquet, articulé, réversible avec bouton de débrayage



* Renewal Kits → 4753BRK → P318

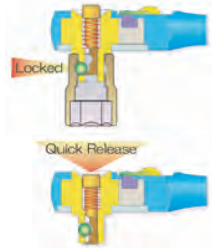
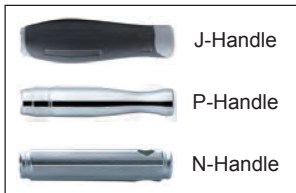
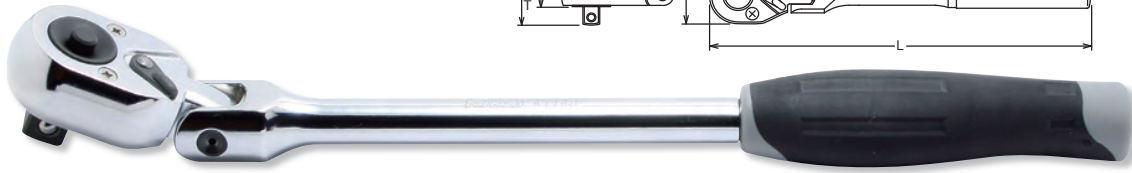

	D (mm)	T (mm)	H (mm)	L (mm)	(g)	(pcs.)
4774JB	38	36.2	21.6	330	685	1
4774PB	38	36.2	21.6	330	700	1
4774NB	38	36.2	21.6	330	700	1

Reversible Ratchet with Quick Release Button :

Sockets and accessories are safely locked. By pushing the button the sockets or extension bars are released from the ratchet.

Umstellbare Knarre mit Entriegelungsknopf :

Steckschlüssel und Zubehörteile werden sicher und fest gehalten. Bei Drücken des Knopfes lösen sich die Teile.

Cliquet réversible avec bouton de débrayage :

Les douilles et accessoires ne peuvent plus se libérer. Une pression du pouce sur le bouton suffit pour les extraire.

⚠ Reversible Ratchet with quick release button has less strength compared with normal ratchet due to the technical design. Make sure to use the ratchet correctly.
Die Umschaltknarre mit Entriegelungsknopf hat aufgrund der technischen Konstruktion eine geringere Festigkeit als eine normale Ratsche. Stellen Sie sicher, dass Sie die Ratsche richtig verwenden.
Le cliquet réversible avec bouton de libération rapide a une résistance moindre que le cliquet normal en raison de sa conception technique. Veuillez à utiliser le cliquet correctement.

4755 Ratchet Adaptor
Aufsteckknarre
Cliquet adaptable

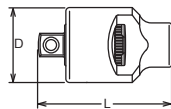

45

* Renewal Kits → 4755RK → P319

	D (mm)	L (mm)	(g)	(pcs.)
4755	33.5	65	270	5

4756 Quick Spinner
Rändel-Drehscheibe
Lanceur

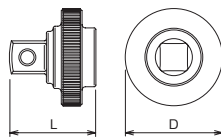

	D (mm)	L (mm)	(g)	(pcs.)
4756	38	34.5	95	10

4768J-380 / -450 / -600

Hinge Handles
Gelenkgriffe
Poignées articulées



* Renewal Kits → 4768RK → P321



4768P-380 / -450 / -600

Hinge Handles
Gelenkgriffe
Poignées articulées

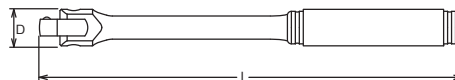

* Renewal Kits → 4768RK → P321



⚠ 4768-450/600 have longer handle than standard, and can be loaded to excessive torque value. Please use carefully.

Der 4768-450 und 4768-600 hat einen längeren Griff als die Standardausführung und kann mit einem zu hohen Drehmoment belastet werden. Bitte vorsichtig verwenden.

Dû au fait que les manches des 4768-450 et 4768-600 sont plus longues que le standard, il y a risque d'une surcharge excessive lors du serrage. Pour éviter casse et blessure, veuillez serrer d'une façon régulière et progressive.

	D (mm)	L (mm)	(g)	(pcs.)
4768J-380	28	380	600	1
4768J-450	28	450	690	1
4768J-600	28	600	1120	1
4768P-380	28	380	665	2
4768P-450	28	450	748	2
4768P-600	28	600	1170	1

Z-SERIES
HAND
TITANIUM
ACCESSORIES
SCREWDRIVERS
IMPACT
SLEEVE-DRIVE
PROTECTOR
INDUSTRIAL
AUTOMOTIVE
MOTORCYCLE
CONSTRUCTION
SPARE PART

	D (mm)	L (mm)	⚖️ (g)	📦 (pcs.)
4760-35	24	35	56	10
4760-50	24	50	92	10
4760-75	24	75	138	10
4760-100	24	100	158	5
4760-125	24	125	194	5
4760-150	24	150	266	5
4760-200	24	200	295	5
4760-250	24	250	358	5
4760-300	24	300	492	2
4760-400	24	400	650	1
4760-500	24	500	808	1
4760-600	24	600	968	1
4760-900	24	900	1430	1
4760-1000	24	1000	1593	1

4760 Extension Bars Verlängerungen Rallonges

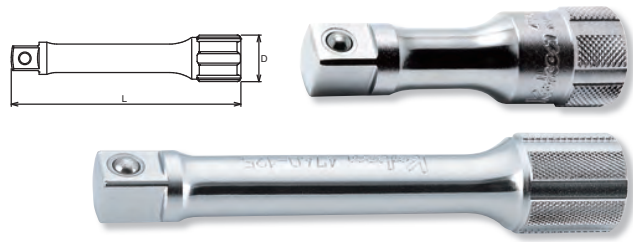

PK4760/5 5 Pieces Set/📦=1,050g

PLASTIC TRAY

Extension Bars

4760 Extension Bars
50, 75, 125, 150, 250

Rotation and general handling of extensions with oily hands is greatly improved with the **Koken** developed 6 point knurling. Also the **Koken** 6 point knurling stops the extensions from rolling around the work area.

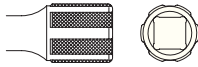

Durch die von **Koken** entwickelte 6 fache Rändelung wird die Handhabung deutlich erleichtert. Außerdem wird das Herumrollen der Verlängerungen wirksam verhindert.

La manipulation des rallonges est grandement facilitée par le profil moleté développé par **Koken**. Ce même profil empêche le roulement intempestif des rallonges sur le plan de travail.

PK4760/5 Extension Bars in Plastic Box Verlängerungen in Kunststoff-Kassette Rallonges en boîte plastique



	D (mm)	L (mm)	⚖️ (g)	📦 (pcs.)
4763-50	24	50	95	10
4763-75	24	75	111	10
4763-125	24	125	157	5
4763-150	24	150	181	5
4763-250	24	250	357	5
4763-300	24	300	480	2
4763-400	24	400	650	1



4763 Wobble-Fix Extension Bars Winkel-Verlängerungen Rallonges angulaires

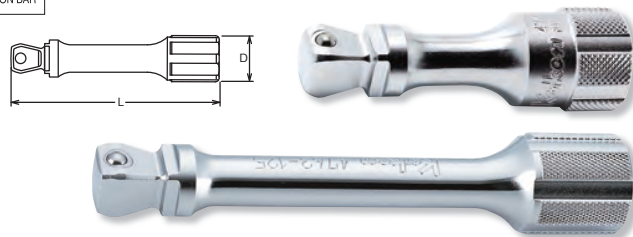

⚠️ The Wobble-Fix Extension Bar has less strength than normal extension bar due to its specific design with a reduced square drive. Make sure to use it correctly.

Die Wobble-Fix Verlängerungen haben aufgrund ihrer speziellen Konstruktion mit einem reduzierten Vierkanttrieb eine geringere Festigkeit als eine normale Verlängerung. Achten Sie darauf, sie richtig zu verwenden.

La barre d'extension angulaire est moins résistante qu'une barre d'extension normale en raison de sa conception spécifique avec un carré d'entraînement réduit. Veuillez l'utiliser correctement.

PK4763/5 5 Pieces Set/📦=950g

PLASTIC TRAY

Extension Bars

4763 Wobble-Fix Extension Bars
50, 75, 125, 150, 250

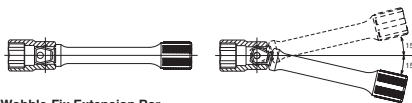

Wobble-Fix Extension Bar

Two way usage

- a) In a fixed position, as a normal extension bar
- b) In a half-fixed position, as a flexible extension bar providing a 15° angle operation

Winkel-Verlängerungen

Winkelverlängerungen lassen sich in zwei Einstellungen verwenden

- a) voll eingesteckt und starr,
- b) halb eingesteckt, mit einem Arbeitswinkel von 15°.

Rallonges angulaires

Deux utilisations possibles

- a) comme rallonge normale, dans une position fixe
- b) comme une rallonge angulaire avec une possibilité d'inclinaison jusqu'à 15°

PK4763/5 Wobble-Fix Extension Bars in Plastic Box Winkel Verlängerungen in Kunststoff-Kassette Rallonges angulaires en boîte plastique



4770 Universal Joint
Gelenk-Einsatz
Cardan universel

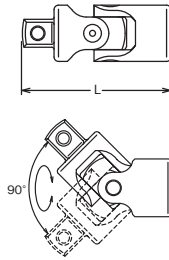

	L (mm)	(g)	(pcs.)
4770	62.4	150	10

4771 Universal Joint
Gelenk-Einsatz
Joint articulé

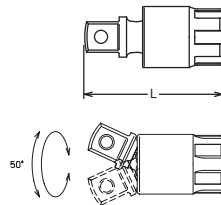

	L (mm)	(g)	(pcs.)
4771	57.7	113	10

4780-400 Speed Handle
Winde
Vilebrequin

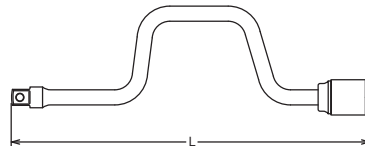
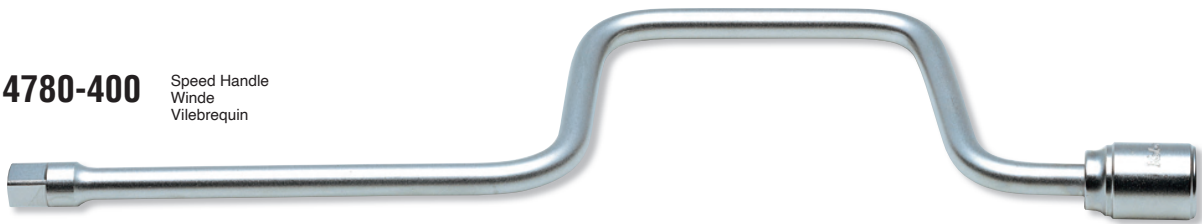

	L (mm)	(g)	(pce.)
4780	400	644	1

4781N-450 Flexible Speed Handle
Gelenkgriff-Winde
Vilebrequin

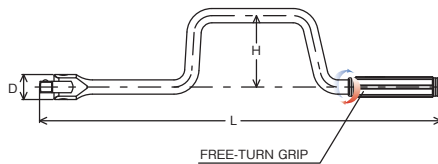

* Renewal Kits → 4768RK → P321

	D (mm)	H (mm)	L (mm)	(g)	(pce.)
4781N-450	28	80	450	1000	1

4785 T-Handle
T-Griff
Poignée coulissante



	L (mm)	(g)	(pcs.)
4785	300	410	2

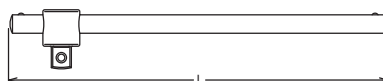

Z-SERIES

HAND

TITANIUM

SCREWDRIVERS ACCESSORIES

IMPACT

SLEEVE-DRIVE

PROTECTOR

INDUSTRIAL

AUTOMOTIVE

MOTORCYCLE

CONSTRUCTION

SPARE PART

1/2"

Hand Sockets Hand Steckschlüssel Douilles à main



4747 L-Handle
L-Griff
Poignées en L



	L ₁ (mm)	L ₂ (mm)	⚖️ (g)	📦 (pcs.)
4747	263	53	470	1

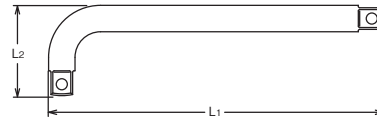

4788-250 / -300 / -450 ⚠️ L-Handles
L-Griffe
Poignées en L



	L ₁ (mm)	L ₂ (mm)	⚖️ (g)	📦 (pcs.)
4788-250	250	53	417	2
4788-300	300	53	503	1
4788-450	450	53	745	1

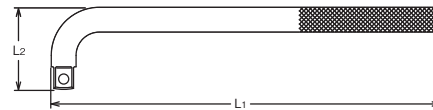

⚠️ 4788-450 have longer handle than standard, and can be loaded to excessive torque value. In the interest of your own safety always apply load evenly and progressively to avoid breakage and possible injury.

	□ (sq.)	⊕ (sq.)	L (mm)	⚖️ (g)	📦 (pcs.)
4433A-35	1/2"	3/8"	35	50	10
4433A-75	1/2"	3/8"	75	120	10
4433A-125	1/2"	3/8"	125	164	5
4433A-250	1/2"	3/8"	250	275	5
4433A-600	1/2"	3/8"	600	530	1

Items in this catalogue marked ⚠️ can be loaded to torque values which may cause breakage. In the interest of your own safety always apply load evenly and progressively to avoid breakage and possible injury.

Die mit ⚠️ gekennzeichneten Artikel können bei Überbelastungen zu Bruch gehen. Aus Gründen Ihrer Sicherheit, sollten die betreffenden Werkzeuge nie ruckartig sondern nach und nach belastet werden, um Bruch und damit verbundene, mögliche Verletzungen zu vermeiden.

Il est possible d'appliquer aux articles marqués ⚠️ des couples de serrage susceptibles d'occasionner leur rupture. Pour votre propre sécurité, veuillez toujours appliquer la charge d'une manière uniforme et progressive. Ceci pour éviter ruptures et accidents.

	□ (sq.)	⊕ (sq.)	L (mm)	⚖️ (g)	📦 (pcs.)
4466A	1/2"	3/4"	42	108	10

4433A Adaptors
Verbindungsstücke
Réducteurs

Warranty 290Nm
Garantie 290Nm
Garantie 290Nm ⚠️



4466A Adaptor
Verbindungsstück
Réducteurs

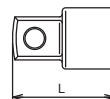

Z-SERIES

HAND

TITANIUM

ACCESSORIES

SCREWDRIVERS

IMPACT

SLEEVE-DRIVE

PROTECTOR

INDUSTRIAL

AUTOMOTIVE

MOTORCYCLE

CONSTRUCTION

SPARE PART

Hand Sockets
Hand Steckschlüssel
Douilles à main **1/2"**

4223M-01 Socket Sets
Steckschlüssel Sätze
Jeux de clés à douilles
4223M-06



4223M-01 15 Pieces Set/△=2,600g
4223M-06 15 Pieces Set/△=2,600g

METAL CASE:W415xH120xT50mm

Sockets		Accessories	
(4223M-01)			
4401M 6-pt. Sockets			4753J
10, 11, 12, 13, 14, 15, 16, 17, 18, 19, 21, 22			4760-125
(4223M-06)			4770
4406M 12-pt. Sockets			
10, 11, 12, 13, 14, 15, 16, 17, 18, 19, 21, 22			

4238AM Socket Sets
Steckschlüssel Sätze
Jeux de clés à douilles



4238AM 38 Pieces Set/△=8,050g

METAL CASE:W446xH266xT50mm

Sockets		Accessories	
4405M 12-pt. Sockets			4753N
10, 11, 12, 13, 14, 15, 16, 17, 18, 19, 21, 22, 23, 24, 26, 27, 30, 32			4760-125
4405A 12-pt. Sockets			4760-250
3/8, 7/16, 1/2, 9/16, 5/8, 11/16, 3/4, 13/16, 7/8, 15/16, 1.1/16, 1.1/8, 1.1/4			4770
4300C Spark Plug Socket			4780
20.8			4785

S4240M-01 Display Stands
Ausstellungsstände
Présentoirs
S4240A-00
S4240M-06
S4240A-05



S4240M-01 4401M 117 Pieces Set/△=13,000g
S4240M-06 4406M 117 Pieces Set/△=13,000g

DISPLAY STAND:W510xH150xT230mm

Sockets		
10mm:9pcs	16mm:9pcs	24mm:6pcs
11mm:9pcs	17mm:8pcs	27mm:5pcs
12mm:9pcs	19mm:7pcs	30mm:5pcs
13mm:9pcs	21mm:7pcs	32mm:4pcs
14mm:9pcs	22mm:6pcs	
15mm:9pcs	23mm:6pcs	

S4240A-00 4400A 103 Pieces Set/△=13,000g
S4240A-05 4405A 103 Pieces Set/△=13,000g

DISPLAY STAND:W510xH150xT230mm

Sockets		
3/8" :9pcs	11/16":8pcs	1" :5pcs
7/16":9pcs	3/4" :7pcs	1.1/16":5pcs
1/2" :9pcs	13/16":7pcs	1.1/8" :5pcs
9/16":9pcs	7/8" :6pcs	1.3/16":5pcs
5/8" :9pcs	15/16":6pcs	1.1/4" :4pcs

Z-SERIES

HAND

TITANIUM

ACCESSORIES

SCREWDRIVERS

IMPACT

SLEEVE-DRIVE

PROTECTOR

INDUSTRIAL

AUTOMOTIVE

MOTORCYCLE

CONSTRUCTION



SPARE PART

1/2"

Hand Sockets
Hand Steckschlüssel
Douilles à main

4241M-01	28 Pieces Set/△=6,500g
4241M-06	28 Pieces Set/△=6,500g
4241M-10	28 Pieces Set/△=6,500g

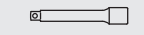
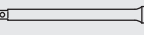
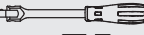
METAL CASE:W446xH266xT50mm

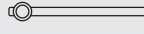
Sockets	Accessories
(4241M-01) 4401M 6-pt. Sockets 10, 11, 12, 13, 14, 15, 16, 17, 18, 19, 20, 21, 22, 23, 24, 25, 26, 27, 28, 29, 30, 32	 4753J  4760-125  4760-250
(4241M-06) 4406M 12-pt. Sockets 10, 11, 12, 13, 14, 15, 16, 17, 18, 19, 20, 21, 22, 23, 24, 25, 26, 27, 28, 29, 30, 32	 4768J-380  4770  4785
(4241M-10) 4410M Surface Drive Sockets 10, 11, 12, 13, 14, 15, 16, 17, 18, 19, 20, 21, 22, 23, 24, 25, 26, 27, 28, 29, 30, 32	

4241M-01

Socket Sets
Steckschlüssel Sätze
Jeux de clés à douilles





4241M-06

4241M-10

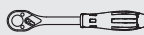

4241A-00	19 Pieces Set/△=4,900g
4241A-05	19 Pieces Set/△=4,900g

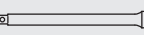
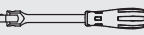
METAL CASE:W445xH190xT50mm

Sockets	Accessories
(4241A-00) 4400A 6-pt. Sockets 3/8, 7/16, 1/2, 9/16, 5/8, 11/16, 3/4, 13/16, 7/8, 15/16, 1.1/16, 1.1/8, 1.1/4	 4753J  4760-125  4760-250
(4241A-05) 4405A 12-pt. Sockets 3/8, 7/16, 1/2, 9/16, 5/8, 11/16, 3/4, 13/16, 7/8, 15/16, 1.1/16, 1.1/8, 1.1/4	 4768J-380  4770  4785

4241A-00





Socket Sets
Steckschlüssel Sätze
Jeux de clés à douilles

4241A-05

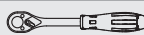

4249M-01	20 Pieces Set/△=4,800g
4249M-06	20 Pieces Set/△=4,800g

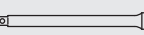
METAL CASE:W445xH190xT50mm

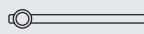
Sockets	Accessories
(4249M-01) 4401M 6-pt. Sockets 10, 11, 12, 13, 14, 15, 16, 17, 18, 19, 21, 22, 24, 27, 30	 4753J  4760-125  4760-250
(4249M-06) 4406M 12-pt. Sockets 10, 11, 12, 13, 14, 15, 16, 17, 18, 19, 21, 22, 24, 27, 30	 4770  4785

4249M-01



Socket Sets
Steckschlüssel Sätze
Jeux de clés à douilles

4249M-06

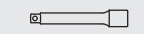
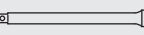

4250M-01	18 Pieces Set/△=4,700g
4250M-06	18 Pieces Set/△=4,700g
4250M-10	18 Pieces Set/△=4,700g

METAL CASE:W445xH190xT50mm

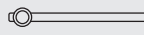
Sockets	Accessories
(4250M-01) 4401M 6-pt. Sockets 10, 11, 12, 13, 14, 15, 17, 19, 22, 24, 27, 30, 32	 4753J  4760-125  4760-250
(4250M-06) 4406M 12-pt. Sockets 10, 11, 12, 13, 14, 15, 17, 19, 22, 24, 27, 30, 32	 4770  4785
(4250M-10) 4410M Surface Drive Sockets 10, 11, 12, 13, 14, 15, 17, 19, 22, 24, 27, 30, 32	

4250M-01

Socket Sets
Steckschlüssel Sätze
Jeux de clés à douilles

4250M-06

4250M-10



Z-SERIES

HAND

TITANIUM

ACCESSORIES

SCREWDRIVERS

IMPACT

SLEEVE-DRIVE

PROTECTOR

INDUSTRIAL

AUTOMOTIVE

MOTORCYCLE

CONSTRUCTION

SPARE PART

4251M-01 Socket Sets
Steckschlüssel Sätze
Jeux de clés à douilles
4251M-06
4251M-10
4251A-00
4251A-05



4251M-01	22 Pieces Set/⚖️=3,200g
4251M-06	22 Pieces Set/⚖️=3,200g
4251M-10	22 Pieces Set/⚖️=3,200g
4251A-00	18 Pieces Set/⚖️=2,700g
4251A-05	18 Pieces Set/⚖️=2,700g

METAL CASE:W330xH68xT48mm

Sockets	
(4251M-01) 4401M 6-pt. Sockets	10, 11, 12, 13, 14, 15, 16, 17, 18, 19, 20, 21, 22, 23, 24, 25, 26, 27, 28, 29, 30, 32
(4251M-06) 4406M 12-pt. Sockets	
(4251M-10) 4410M Surface Drive Sockets	
(4251A-00) 4400A 6-pt. Sockets	3/8, 7/16, 1/2, 9/16, 19/32, 5/8, 21/32, 11/16, 3/4, 25/32, 13/16, 7/8, 15/16, 1, 1.1/16, 1.1/8, 1.3/16, 1.1/4
(4251A-05) 4405A 12-pt. Sockets	

4252M-01 Socket Sets
Steckschlüssel Sätze
Jeux de clés à douilles
4252M-06
4252M-10



4252M-01	13 Pieces Set/⚖️=1,200g
4252M-06	13 Pieces Set/⚖️=1,200g
4252M-10	13 Pieces Set/⚖️=1,200g

METAL CASE:W168xH60xT42mm

Sockets	
(4252M-01) 4401M 6-pt. Sockets	10, 11, 12, 13, 14, 15, 16, 17, 18, 19, 20, 21, 22
(4252M-06) 4406M 12-pt. Sockets	
(4252M-10) 4410M Surface Drive Sockets	

4254 Socket Sets
Steckschlüssel Sätze
Jeux de clés à douilles



4254	12 Pieces Set/⚖️=1,070g
------	-------------------------

METAL CASE:W215xH80xT47mm

Sockets		Accessories	
3/8" 3425- E6, E8		4763-50	
1/2" 4425- E10, E12, E14		4433A-35	
3/8" 3325- E6, E8			
1/2" 4325- E10, E12, E14			

4262M-01 Socket Sets
Steckschlüssel Sätze
Jeux de clés à douilles
4262M-06
4262M-10



4262M-01	20 Pieces Set/⚖️=4,400g
4262M-06	20 Pieces Set/⚖️=4,400g
4262M-10	20 Pieces Set/⚖️=4,400g

METAL CASE:W445xH190xT50mm

Sockets		Accessories	
(4262M-01) 4401M 6-pt. Sockets	8, 10, 11, 12, 13, 14, 15, 16, 17, 18, 19, 21, 22, 24, 27	4753J	
(4262M-06) 4406M 12-pt. Sockets	8, 10, 11, 12, 13, 14, 15, 16, 17, 18, 19, 21, 22, 24, 27	4760-125	
(4262M-10) 4410M Surface Drive Sockets	8, 10, 11, 12, 13, 14, 15, 16, 17, 18, 19, 21, 22, 24, 27	4760-250	
		4770	
		4785	

1/2"

Hand Sockets
Hand Steckschlüssel
Douilles à main

4272AM-01		29 Pieces Set/△=5,000g	
4272AM-06		29 Pieces Set/△=5,000g	
METAL CASE:W445xH190xT50mm			
Sockets	Accessories		
(4272AM-01)			
4401M 6-pt. Sockets		4753J	
10, 11, 12, 13, 14, 15, 16, 17, 18, 19, 21, 22, 24		4760-125	
4400A 6-pt. Sockets		4760-250	
3/8, 7/16, 1/2, 9/16, 5/8, 11/16, 3/4, 13/16, 7/8, 15/16, 1		4770	
(4272AM-06)			
4406M 12-pt. Sockets		4785	
10, 11, 12, 13, 14, 15, 16, 17, 18, 19, 21, 22, 24			
4405A 12-pt. Sockets			
3/8, 7/16, 1/2, 9/16, 5/8, 11/16, 3/4, 13/16, 7/8, 15/16, 1			

4275		24 Pieces Set/△=5,340g	
METAL CASE:W445xH190xT50mm			
Sockets	Accessories		
4406M 12-pt. Sockets		4750J	
10, 11, 12, 13, 14, 15, 16, 17, 18, 19, 21, 22, 24		4760-125	
4300C Spark Plug Sockets		4760-250	
16, 20.8		4768J-380	
4300M Wheel Nut Sockets		4770	
17(L60), 19(L60), 21(L60)		4785	

4276		17 Pieces Set/△=2,890g	
METAL CASE:W370xH150xT50mm			
Sockets	Accessories		
4010M.50 Bit Sockets		4752J	
6, 7, 8, 10, 12, 14		4763-125	
4025.60 TORX® Bit Sockets			
T20, T25, T27, T30, T40, T45, T50, T55, T60			

4277		27 Pieces Set/△=5,660g	
METAL CASE:W445xH190xT50mm			
Sockets	Accessories		
4406M 12-pt. Sockets		4750J	
10, 12, 13, 14, 15, 16, 17, 18, 19, 21, 22, 24		4760-125	
4305M 12-pt. Deep Sockets		4768J-380	
10, 12, 13, 14, 15, 16, 17, 18, 19, 21, 22, 24			

4272AM-01 Socket Sets
Steckschlüssel Sätze
Jeux de clés à douilles

4272AM-06



4275 Socket Sets
Steckschlüssel Sätze
Jeux de clés à douilles



4276 Socket Sets
Steckschlüssel Sätze
Jeux de clés à douilles



4277 Socket Sets
Steckschlüssel Sätze
Jeux de clés à douilles



Z-SERIES

HAND

TITANIUM

ACCESSORIES

SCREWDRIVERS

IMPACT

SLEEVE-DRIVE

PROTECTOR

INDUSTRIAL

AUTOMOTIVE

MOTORCYCLE

CONSTRUCTION

SPARE PART

6400M / 6400A

6-point Sockets
6-kant Steckschlüssel
Douilles 6-pans

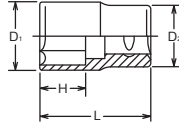

6405M / 6405A

12-point Sockets
12-kant Steckschlüssel
Douilles 12-pans

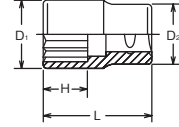

6400M 6405M (mm)	D ₁ (mm)	D ₂ (mm)	H (mm)	L (mm)	(g)	(pcs.)
14	22.1	34	11	50	160	10
16	24.6	34	12	50	167	10
17	26	34	12.5	50	175	5
18	27	34	13	50	178	5
19	28.5	34	13.5	50	179	5
20	29.5	34	14	50	185	5
21	31	34	14.5	50	185	5
22	32	34	15	50	187	5
23	33.5	34	16	50	187	5
24	34.5	34	17	50	200	5
25	36	34	17.5	50	217	5
26	37	34	18	50	222	5
27	38.5	37	19	53	254	5
28	39.5	38	19.5	53	298	5
29	41	38	20	55	292	5
30	42	38	21	55	301	5
31	43.5	38	22	57	294	5
32	44.5	40	23	57	351	5
33	46	40	23.5	57	384	5
34	47	40	24	57	397	5
35	48.5	42	24.5	59	422	5
36	49.5	42	25	59	438	5
37	51	42	25.5	59	484	5
38	52	45	26	59	523	5
39	53.5	45	26.5	59	538	5
40	54.5	45	27	62	550	5
41	56	47	28	62	633	5
42	57	47	28.5	62	652	2
43	58.5	47	29	62	659	2
44	59.5	47	29.5	62	657	2
45	61	47	30	68	734	2
46	62	47	31	68	791	2
47	63.5	48	31.5	68	816	2
48	64.5	45	32	68	800	2
50	67	48	34	68	880	2
52	69.5	53	33	72	925	2
54	72	55	33	72	1040	2
55	73.5	53	36	72	1006	2
56	74.5	53	36	72	1092	2
57	76	53	36	72	1169	2
58	77	53	36	72	1149	2
60	79.5	58	39	76	1402	2
63	83.5	58	39	76	1494	2
65	86	63	42	80	1608	2
70	92	68	45	84	1785	2
75	98.5	73	48	86	2186	1
78	102.1	73	55	86	2425	1
80	104.5	78	52	90	2475	1
85	111	78	52	90	2620	1

6400A 6405A (inch)	D ₁ (mm)	D ₂ (mm)	H (mm)	L (mm)	(g)	(pcs.)
5/8	24.6	34	12	50	168	10
11/16	27	34	13	50	178	5
3/4	28.5	34	13.5	50	179	5
25/32	29.5	34	14	50	185	5
13/16	31	34	14.5	50	185	5
7/8	32	34	15	50	187	5
15/16	34.5	34	17	50	200	5
31/32	36	34	17.5	50	217	5
1	37	34	18	50	222	5
1. 1/16	38.5	37	19	53	254	5
1. 1/8	41	38	20	53	292	5
1. 3/16	42	38	21	55	301	5
1. 1/4	44.5	40	23	57	351	5
1. 5/16	46	40	23.5	57	384	5
1. 3/8	48.5	42	24.5	57	422	5
1. 7/16	51	42	25.5	59	484	5
1. 1/2	52	45	26	59	523	5
1. 9/16	54.5	45	27	59	550	5
1. 5/8	56	47	28	62	633	5
1.11/16	58.5	47	29	62	659	2
1. 3/4	59.5	47	29.5	62	657	2
1.13/16	62	47	31	68	791	2
1. 7/8	64.5	45	32	68	892	2
1.15/16	66	48	32.5	68	870	2
2	68.5	52	34.5	68	949	2
2. 1/16	71	54	33	72	983	2
2. 1/8	72	55	33	72	1040	2
2. 3/16	74.5	53	36	72	1092	2
2. 1/4	76	53	36	72	1169	2
2. 5/16	78.5	53	36	72	1344	2
2. 3/8	79.5	58	39	76	1402	2
2. 7/16	82	58	39	76	1420	2
2. 1/2	84.5	58	39	76	1497	2
2. 9/16	86	63	42	80	1608	2
2. 5/8	88.5	63	42	80	1709	2
2.11/16	89.5	63	42	80	1634	2
2. 3/4	92	68	45	84	1785	2
2.13/16	94.5	68	45	84	2018	2
2. 7/8	96	68	45	84	2062	2
2.15/16	98.5	73	48	86	2186	1
3	101	73	48	86	2309	1
3. 1/8	104.5	78	52	90	2475	1

6425

TORX® Sockets
TORX® Steckschlüssel
Douilles TORX®

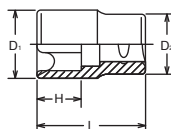



6425 (E)	D ₁ (mm)	D ₂ (mm)	H (mm)	L (mm)	(g)	(pcs.)
E18	22.1	34	11.9	50	156	5
E20	24.6	34	13.3	50	166	5
E22	27.1	34	14.4	50	178	5
E24	28.6	34	16	50	185	5
E26	31.1	34	17.7	55	217	5
E28	32.1	34	24.1	60	237	5
E30	35	34	24.1	60	242	5
E32	36.1	34	24.1	60	247	5

TORX® is a registered trademark of CAMCAR Innovations.
TORX® ist ein registriertes Markenzeichen der Firma CAMCAR Innovations.
TORX® est une marque déposée de CAMCAR Innovations.

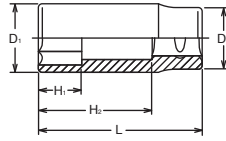

6300M / 6300A 6-point Deep Sockets 6-kant-Steckschlüssel, lang Douilles longues 6-pans





6300M 6305M (mm)	D ₁ (mm)	D ₂ (mm)	H ₁ (mm)	H ₂ (mm)	L (mm)	 (g)	 (pcs.)
17	26	34	18	64	90	278	5
18	27	34	19	64	90	281	5
19	28.5	34	20	64	90	292	5
20	29.5	34	21	64	90	334	5
21	31	34	22	64	90	343	5
22	32	34	23	64	90	347	5
23	33.5	34	24	64	90	361	5
24	34.5	34	25	64	90	352	5
25	36	34	26	64	90	369	5
26	37	34	27	64	90	384	5
27	38.5	37	28	64	90	425	5
28	39.5	38	29	63	90	470	5
29	41	38	30	63	90	503	5
30	42	38	31	63	90	503	5
31	43.5	38	32	62	90	517	5
32	44.5	40	34	62	90	544	5
33	46	40	34	62	90	557	5
34	47	40	35	61	90	570	5
35	48.5	42	36	61	90	622	5
36	49.5	42	37	61	90	631	2
38	52	45	39	60	90	710	2
40	54.5	45	41	60	90	742	2
41	56	47	42	59	90	802	2
42	57	47	43	59	90	829	2
44	59.5	47	45	59	90	838	2
46	62	47	47	58	90	906	2
48	64.5	50	49	57	90	998	2
50	67	48	51	57	90	1005	2
52	69.5	53	49	-	100	1270	2
53	71	54	49	-	100	1338	2
54	72	55	49	-	100	1351	2
55	73.5	53	52	-	100	1388	2
56	74.5	53	52	-	100	1389	2
57	76	53	52	-	100	1467	2
58	77	53	52	-	100	1480	2
60	79.5	58	55	-	100	1626	2
63	83.5	58	55	-	100	1740	2
65	86	63	65	-	100	1939	2

6305M / 6305A 12-point Deep Sockets 12-kant Steckschlüssel, lang Douilles longues, 12-pans



6300A 6305A (inch)	D ₁ (mm)	D ₂ (mm)	H ₁ (mm)	H ₂ (mm)	L (mm)	 (g)	 (pcs.)
3/4	28.5	34	20	64	90	292	5
25/32	29.5	34	21	64	90	334	5
13/16	31	34	22	64	90	343	5
7/8	32	34	23	64	90	347	5
15/16	34.5	34	25	64	90	352	5
1	37	34	27	64	90	384	5
1. 1/16	38.5	37	28	64	90	425	5
1. 1/8	41	38	30	63	90	503	5
1. 3/16	42	38	31	63	90	503	5
1. 1/4	44.5	40	34	62	90	544	5
1. 5/16	46	40	34	62	90	557	5
1. 3/8	48.5	42	36	61	90	622	5
1. 7/16	51	42	38	61	90	656	2
1. 1/2	52	45	39	60	90	710	2
1. 9/16	54.5	45	41	60	90	742	2
1. 5/8	56	47	42	59	90	802	2
1.11/16	58.5	47	44	59	90	831	2
1. 3/4	59.5	47	45	59	90	838	2
1.13/16	62	47	47	58	90	906	2
2	68.5	52	52	57	90	1061	2
2. 1/16	71	54	49	-	100	1338	2
2. 1/8	72	55	49	-	100	1351	2
2. 3/16	74.5	53	52	-	100	1389	2
2. 1/4	76	53	52	-	100	1467	2
2. 5/16	78.5	53	52	-	100	1787	2
2. 3/8	79.5	58	55	-	100	1626	2
2. 7/16	82	58	55	-	100	1715	2

6012M-75 (mm)	D (mm)	H ₁ (mm)	H ₂ (mm)	L (mm)	 (g)	 (pcs.)
12	35	15.5	40	75	253	10
14	35	15.5	40	75	265	10
15	35	15.5	40	75	271	10
16	35	15.5	40	75	285	10
17	35	15.5	40	75	292	10
18	35	15.5	40	75	302	10
19	35	15.5	40	75	312	10
20	35	15.5	40	75	323	10
21	38	15.5	40	75	330	10
22	38	22.5	40	75	340	10
24	38	22.5	40	75	362	10
27	38	22.5	40	75	402	10
30	38	28.5	40	75	445	10
32	38	28.5	40	75	485	10
36	42	28.5	40	75	663	10

6012M-75 Inhex Sockets Steckschlüssel für Innensechskant-Schrauben Douilles tournevis pour vis 6-pans creux

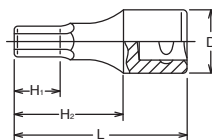

6101 Socket for Slotted Heads Steckschlüssel für Schlitzschrauben Douilles tournevis pour vis à fente

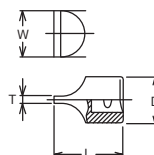

	TxW (mm)	D (mm)	L (mm)	 (g)	 (pcs.)
6101	6.4x33.5	35	50	205	5

6749
6749-1000 ⚠️
6749-HEAD
PIPE-400 / -800

Reversible Ratchet
Knarre, verstellbar
Cliquet, réversible



* Renewal Kits → **6749RK** → P318

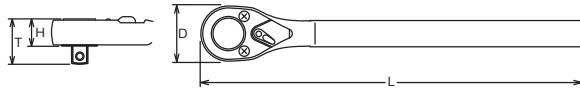

	D (mm)	T (mm)	H (mm)	L (mm)	(g)	(pce.)
6749	68	49.6	29.6	565	2840	1
6749-1000	68	49.6	29.6	965	3960	1
6749-HEAD	68	49.6	29.6	165	1730	1
PIPE-400	–	–	–	400	1110	1
PIPE-800	–	–	–	800	2230	1

⚠️ 6749-1000 has longer handle than standard, and can be loaded to excessive torque value. In the interest of your own safety always apply load evenly and progressively to avoid breakage and possible injury.

Der Gelenkgriff 6749-1000 ist länger als die Standardversion. Aus Gründen Ihrer Sicherheit, sollten dies Werkzeug nie ruckartig sondern nach und nach belastet werden, um Bruch und damit verbundene, mögliche Verletzungen zu vermeiden.

Dû au fait que la manche de la 6749-1000 est plus longue que le standard, il y a risque d'une surcharge excessive lors du serrage. Pour éviter casse et blessure, veuillez serrer d'une façon régulière et progressive.



6752
6752-HEAD
PIPE-400

Reversible Ratchet
Knarre, verstellbar
Cliquet, réversible



* Renewal Kits → **6752RK** → P319

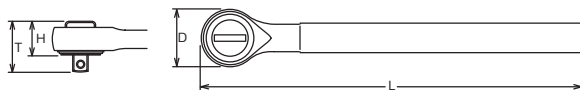

	D (mm)	T (mm)	H (mm)	L (mm)	(g)	(pce.)
6752	67	55.5	35.5	500	2360	1
6752-HEAD	67	55.5	35.5	100	1250	1
PIPE-400	–	–	–	400	1110	1



3/4"

Hand Sockets
Hand Steckschlüssel
Douilles à main

Z-SERIES
HAND
TITANIUM
ACCESSORIES
SCREWDRIVERS
IMPACT
SLEEVE-DRIVE
PROTECTOR
INDUSTRIAL
AUTOMOTIVE
MOTORCYCLE
CONSTRUCTION
SPARE PART

60

* Renewal Kits → 6755RK → P319

	D (mm)	L (mm)	(g)	(pce.)
6755	62	97	1162	1

6755 Ratchet Adaptor
Aufsteckknarre
Cliquet adaptable

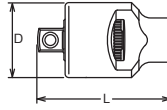

6760 Extension Bars
Verlängerungen
Rallonges



	D (mm)	L (mm)	(g)	(pcs.)
6760-75	35	75	335	5
6760-100	35	100	434	2
6760-125	35	125	528	2
6760-150	35	150	624	2
6760-200	35	200	815	1
6760-300	35	300	1203	1
6760-400	35	400	1585	1

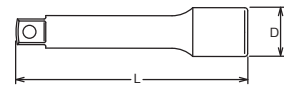

6768 Hinge Handle
Gelenkgriff
Poignée articulée



* Renewal Kits → 6768RK → P321

	D (mm)	L (mm)	(g)	(pce.)
6768	42	450	1715	1

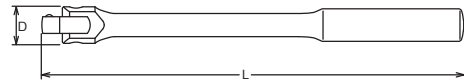

6768-600 / -1000 ⚠ Hinge Handle
Gelenkgriff
Poignée articulée
6768-HEAD
PIPE-400 / -800



* Renewal Kits → 6768RK → P321

	D (mm)	L (mm)	(g)	(pce.)
6768				
6768-600	42	600	2360	1
6768-1000	42	1000	3480	1
6768-HEAD	42	200	1250	1
PIPE-400	-	400	1110	1
PIPE-800	-	800	2230	1

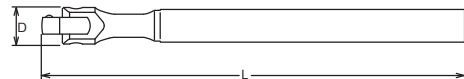

⚠ 6768-600/-1000 have longer handle than standard, and can be loaded to excessive torque value. In the interest of your own safety always apply load evenly and progressively to avoid breakage and possible injury.

Der Art. 6768-600/-1000 hat einen längeren Griff als die Standardausführung und kann mit einem zu hohen Drehmoment belastet werden. Bitte vorsichtig verwenden.

Dù au fait que les manches des 6768-600 et 6768-1000 sont plus longues que le standard, il y a un risque d'une surcharge excessive lors du serrage. Pour éviter casse et blessure, veuillez serrer d'une façon régulière et progressive.



6785 T-Handle
T-Griff
Poignée coulissante

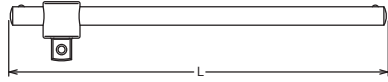
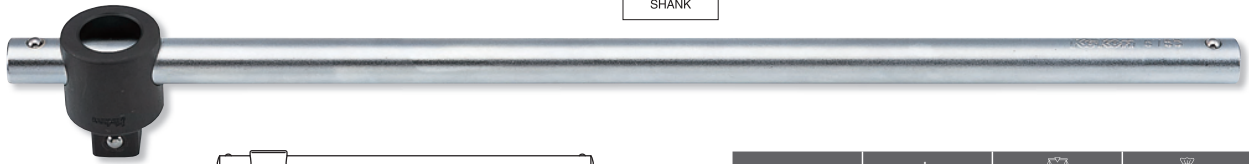

	L (mm)	(g)	(pce.)
6785	500	1542	1

6788 L-Handle
L-Griff
Poignée en L

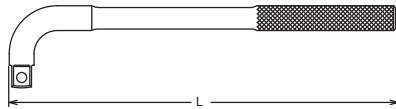

	L (mm)	(g)	(pce.)
6788	330	1175	1

6770 Universal Joint
Gelenk-Einsatz
Cardan universel

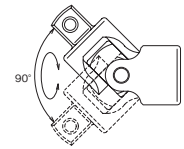
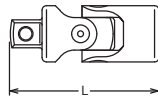

	L (mm)	(g)	(pcs.)
6770	105	478	2

6644A Adaptor
Verbindungsstück
Réducteur

Warranty 668Nm
Garantie 668Nm
Garantie 668Nm



	(sq.)	(sq.)	L (mm)	(g)	(pcs.)
6644A	3/4"	1/2"	47	136	5
6688A	3/4"	1"	60	285	5

Adapting down from bigger square drive to smaller square drive may lead to excessive torque load and possibly cause breakage. Always stay within safe torque of the smaller square drive.

Die mit gekennzeichneten Artikel können bei Überbelastung zu Bruch gehen. Aus Gründen Ihrer eigenen Sicherheit sollten die betreffenden Werkzeuge nie ruckartig, sondern nach und nach belastet werden, um Bruch und damit verbundene mögliche Verletzungen zu vermeiden.

Il est possible d'appliquer aux articles marqués des couples de serrage susceptibles d'occasionner leur rupture. Pour votre propre sécurité, veuillez toujours appliquer la charge d'une manière uniforme et progressive. Ceci pour éviter ruptures et accidents.

6688A Adaptor
Verbindungsstück
Augmentateur

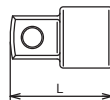

3/4"

Hand Sockets
Hand Steckschlüssel
Douilles à main

Z-SERIES
HAND
TITANIUM
ACCESSORIES
SCREWDRIERS
IMPACT
SLEEVE-DRIVE
PROTECTOR
INDUSTRIAL
AUTOMOTIVE
MOTORCYCLE
CONSTRUCTION
SPARE PART

6201M-00 Socket Sets
6201A-00 Steckschlüssel Sätze
6201M-05 Jeux de clés à douilles
6201A-05



6201A-00	18 Pieces Set/Δ=17,600g
6201A-05	18 Pieces Set/Δ=17,600g
METAL CASE:W580xH200xT85mm	
Sockets	Accessories
(6201A-00) 6400A 6-pt. Sockets 7/8, 15/16, 1.1/16, 1.1/8, 1.1/4, 1.5/16, 1.7/16, 1.1/2, 1.5/8, 1.11/16, 1.13/16, 1.7/8, 2	6749 6760-200 6760-400 6768 6785
(6201A-05) 6405A 12-pt. Sockets 7/8, 15/16, 1.1/16, 1.1/8, 1.1/4, 1.5/16, 1.7/16, 1.1/2, 1.5/8, 1.11/16, 1.13/16, 1.7/8, 2	6749 6760-200 6760-400 6768 6785

6201M-00	16 Pieces Set/Δ=17,300g
6201M-05	16 Pieces Set/Δ=17,300g
METAL CASE:W580xH200xT85mm	
Sockets	Accessories
(6201M-00) 6400M 6-pt. Sockets 22, 24, 27, 30, 32, 36, 41, 46, 50, 55, 60	6749 6760-200 6760-400 6768 6785
(6201M-05) 6405M 12-pt. Sockets 22, 24, 27, 30, 32, 36, 41, 46, 50, 55, 60	6749 6760-200 6760-400 6768 6785

6212M-00 Socket Sets
6212M-05 Steckschlüssel Sätze
Jeux de clés à douilles



6212M-00	12 Pieces Set/Δ=8,200g
6212M-05	12 Pieces Set/Δ=8,200g
METAL CASE:W580xH124xT70mm	
Sockets	Accessories
(6212M-00) 6400M 6-pt. Sockets 22, 24, 27, 30, 32, 36, 41, 46, 50	6749 6760-200 6785
(6212M-05) 6405M 12-pt. Sockets 22, 24, 27, 30, 32, 36, 41, 46, 50	6749 6760-200 6785

Hand Sockets Hand Steckschlüssel Douilles à main



8400M / 8400A

6-point Sockets
6-kant Steckschlüssel
Douilles 6-pans

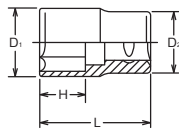

8405M / 8405A

12-point Sockets
12-kant Steckschlüssel
Douilles 12-pans

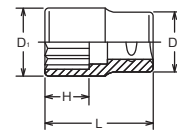

8400M 8405M (mm)	D ₁ (mm)	D ₂ (mm)	H (mm)	L (mm)	(g)	(pce.)
24	36.5	44	17	60	348	1
27	40.5	44	19	60	362	1
28	41.5	44	19.5	60	368	1
29	43	44	20	60	378	1
30	44	45	21	65	410	1
32	46.5	45	23	65	455	1
33	48	46	23.5	65	485	1
34	49	46	24	65	500	1
35	50.5	48	24.5	65	536	1
36	51.5	48	25	65	600	1
38	54	50	26	65	624	1
40	56.5	53	27	65	686	1
41	58	53	28	68	747	1
42	59	53	28.5	68	789	1
46	64	53	31	72	928	1
50	69	53	34	72	943	1
54	74	55	37	72	1016	1
55	75.5	53	42	77	1167	1
56	76.5	53	42	77	1160	1
58	79	53	41	77	1200	1
60	81.5	58	46	82	1440	1
63	85.5	58	45	82	1470	1
64	86.5	58	46	82	1540	1
65	88	63	49	86	1683	1
67	90.5	63	49	86	1840	1
68	91.5	63	49	86	1800	1
70	94	68	50	88	1963	1
71	95.5	68	50	88	2200	1
75	100.5	73	53	90	2204	1
78	104	75	52.5	90	2500	1
80	106.5	75	58	95	2550	1
83	110.5	78	57	95	2730	1
85	113	80	57	95	2680	1
90	119	80	59	100	3420	1
95	125.5	85	58	100	4900	1
100	131.5	85	57	100	4840	1

8400A 8405A (inch)	D ₁ (mm)	D ₂ (mm)	H (mm)	L (mm)	(g)	(pce.)
15/16	36.5	44	17	60	355	1
1. 3/16	44	45	21	65	410	1
1. 1/4	46.5	45	23	65	455	1
1. 5/16	48	46	23.5	65	485	1
1. 3/8	50.5	48	24.5	65	536	1
1. 7/16	53	50	25.5	65	607	1
1. 1/2	54	50	26	65	624	1
1. 9/16	56.5	53	27	65	686	1
1. 5/8	58	53	28	68	747	1
1.11/16	60.5	53	29	68	830	1
1. 3/4	61.5	53	29.5	68	807	1
1.13/16	64	53	31	72	928	1
1. 7/8	66.5	53	32	72	936	1
1.15/16	68	53	32.5	72	941	1
2	70.5	53	37	72	976	1
2. 1/16	73	54	37	72	1027	1
2. 1/8	74	55	37	72	1016	1
2. 3/16	76.5	53	41	77	1192	1
2. 1/4	78	53	41	77	1177	1
2. 5/16	80.5	53	41	77	1292	1
2. 3/8	81.5	58	46	82	1440	1
2. 7/16	84	58	45	82	1495	1
2. 1/2	86.5	58	45	82	1497	1
2. 9/16	88	63	49	86	1683	1
2. 5/8	90.5	63	49	86	1840	1
2.11/16	91.5	63	49	86	1800	1
2. 3/4	94	68	50	88	1963	1
2.13/16	96.5	68	50	88	2035	1
2. 7/8	98	70	50	88	2100	1
2.15/16	100.5	73	53	90	2204	1
3	103	75	53	90	2406	1
3. 1/8	106.5	75	58	95	2550	1
3. 1/4	110.5	78	57	95	2730	1
3. 3/8	114	80	57	95	3050	1
3. 1/2	119	80	59	100	3420	1
3. 3/4	125.5	85	58	100	4900	1

8012M-80 (mm)	D (mm)	H ₁ (mm)	H ₂ (mm)	L (mm)	(g)	(pcs.)
17	44.2	15.5	45	80	400	5
19	44.2	15.5	45	80	410	5
22	47.9	22.5	45	80	436	5
24	47.9	22.5	45	80	471	5
27	47.9	22.5	45	80	526	5
30	47.9	22.5	45	80	658	5
32	47.9	22.5	45	80	715	5
36	54.2	22.5	45	80	945	5

8012M-80 Inhex Sockets
Steckschlüssel für Innensechskant-Schrauben
Douilles tournevis pour vis 6-pans creux

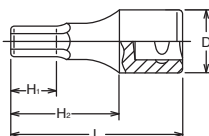

8760 Extension Bars
Verlängerungen
Rallonges



	D (mm)	L (mm)	(g)	(pcs.)
8760-200	44	200	1300	1
8760-400	44	400	2570	1



	L (mm)	(g)	(pcs.)
8770	143	1170	1

8770 Universal Joint
Gelenk-Einsatz
Cardan universel

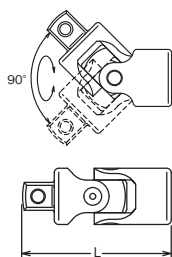

	(sq.)	(sq.)	L (mm)	(g)	(pcs.)
8866A	1"	3/4"	60	338	5

8866A Adaptor
Verbindungsstück
Réducteur
Warranty 1850Nm
Garantie 1850Nm
Garantie 1850Nm

⚠ Adapting down from bigger square drive to smaller square drive may lead to excessive torque and possibly cause breakage.

Reduzierstücke sind mit Vernunft einzusetzen.
Es besteht Bruchgefahr. Überschreiten Sie niemals die Sicherheitsgrenzen.

Les réducteurs doivent être utilisés avec modération. Ne dépassez jamais les limites de sécurité.

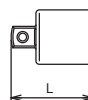

8749
8749-1000 ⚠
8749-HEAD
PIPE-580 / -800

Reversible Ratchet
Knarre, verstellbar
Cliquet, réversible



* Renewal Kits → **8749RK** → P318

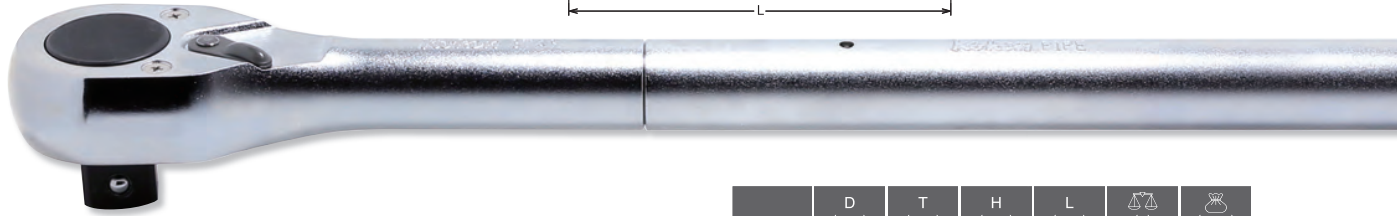
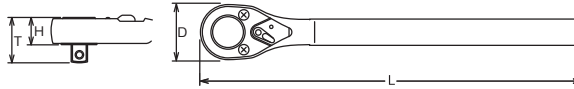

⚠ 8749-1000 has longer handle than standard, and can be loaded to excessive torque value. In the interest of your own safety always apply load evenly and progressively to avoid breakage and possible injury.
Der Art. 8749-1000 hat einen längeren Griff als die Standardausführung und kann mit einem zu hohen Drehmoment belastet werden. Bitte vorsichtig verwenden.
Dû au fait que la manche de la 8749-1000 est plus longue que le standard, il y a risque d'une surcharge excessive lors du serrage. Pour éviter casse et blessure, veuillez serrer d'une façon régulière et progressive.

	D (mm)	T (mm)	H (mm)	L (mm)	(g)	(pce.)
8749	70	62.2	36.2	800	4100	1
8749-1000	70	62.2	36.2	1020	4720	1
8749-HEAD	70	62.2	36.2	220	2490	1
PIPE-580	-	-	-	580	1610	1
PIPE-800	-	-	-	800	2230	1

8768
8768-1000 ⚠
8768-HEAD
PIPE-400 / -800

Hinge Handle
Gelenkgriff
Poignée articulée

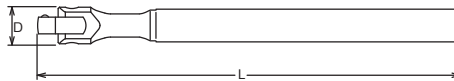

⚠ 8768-1000 has longer handle than standard, and can be loaded to excessive torque value. In the interest of your own safety always apply load evenly and progressively to avoid breakage and possible injury.
Der Art. 8768-1000 hat einen längeren Griff als die Standardausführung und kann mit einem zu hohen Drehmoment belastet werden. Bitte vorsichtig verwenden.
Dû au fait que la manche de la 8768-1000 est plus longue que le standard, il y a risque d'une surcharge excessive lors du serrage. Pour éviter casse et blessure, veuillez serrer d'une façon régulière et progressive.

* Renewal Kits → **8768RK** → P321

	D (mm)	L (mm)	(g)	(pce.)
8768	55	600	2590	1
8768-1000	55	1000	3710	1
8768-HEAD	55	200	1480	1
PIPE-400	-	400	1110	1
PIPE-800	-	800	2230	1

8785
8785-700

T-Handle
T-Griff
Poignée coulissante

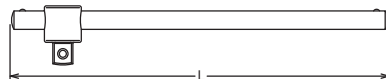
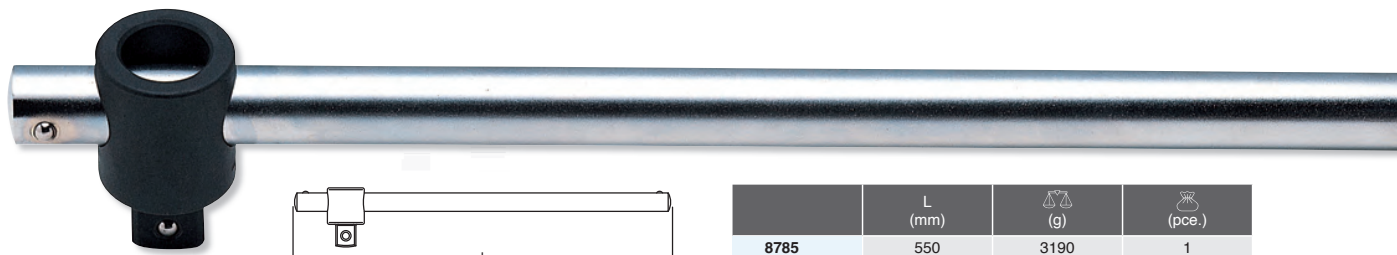

	L (mm)	(g)	(pce.)
8785	550	3190	1
8785-700	700	3906	1

8788
L-Handle
L-Griff
Poignée en L

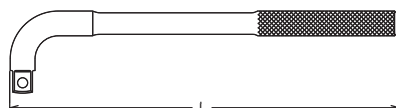
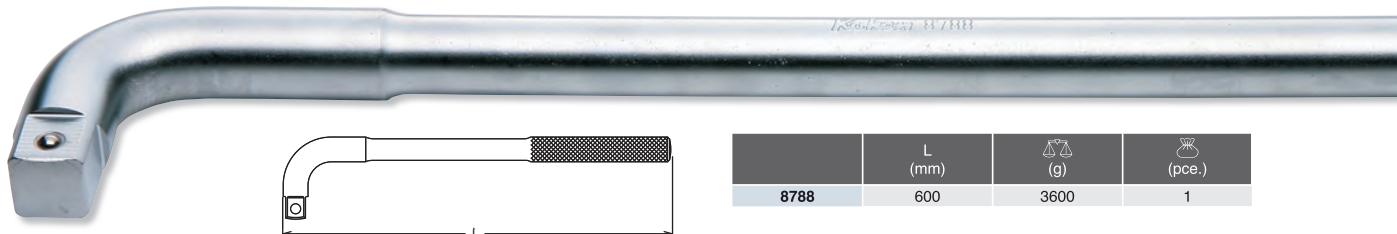

	L (mm)	(g)	(pce.)
8788	600	3600	1

1”

Hand Sockets
Hand Steckschlüssel
Douilles à main

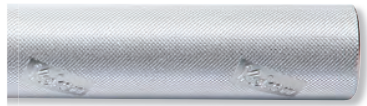

Z-SERIES

HAND

TITANIUM

ACCESSORIES

SCREWDRIVERS

IMPACT

SLEEVE-DRIVE

PROTECTOR

INDUSTRIAL

AUTOMOTIVE

MOTORCYCLE

CONSTRUCTION

SPARE PART



Hand Sockets
Hand Steckschlüssel
Douilles à main **1"**

8225M-00 Socket Sets
Steckschlüssel Sätze
Jeux de clés à douilles
8225M-05

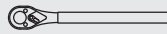

8225M-00 15 Pieces Set/△=27,000g
8225M-05 15 Pieces Set/△=27,000g

METAL CASE:W600xH217xT97mm

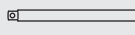
Sockets	Accessories
(8225M-00) 8400M 6-pt. Sockets 32, 33, 36, 41, 46, 50, 55, 60, 65, 70, 75, 80	 8749
(8225M-05) 8405M 12-pt. Sockets 32, 33, 36, 41, 46, 50, 55, 60, 65, 70, 75, 80	 8760-200
	 8760-400

