

# HAND

SOCKETS  
STECKSCHLÜSSEL  
DOUILLES

1/4"

3/8"

1/2"

3/4"

1"



Z-SERIES  
HAND  
TITANIUM  
SCREWDRIVERS ACCESSORIES  
IMPACT  
SLEEVE-DRIVE  
PROTECTOR  
INDUSTRIAL  
AUTOMOTIVE  
MOTORCYCLE  
CONSTRUCTION  
SPARE PART

## 2400M / 2400A

6-point Sockets  
6-kant Steckschlüssel  
Douilles 6-pans

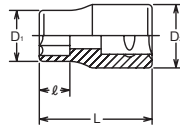

2400M 2405M (mm)	D <sub>1</sub> (mm)	D <sub>2</sub> (mm)	ℓ (mm)	L (mm)	(g)	(pcs.)
3	5.5	11.2	2.6	22	7	10
3.5	6.1	11.2	3	22	7	10
4	6.7	11.2	3.5	22	8	10
4.5	7.3	11.2	4	22	8	10
5	8	11.2	5	22	8	10
5.5	8.5	11.2	5.5	22	9	10
6	9.2	11.2	5.5	22	9	10
7	10.3	11.2	6	22	9	10
8	11.2	11.7	6.9	22	11	10
9	13	12	7.3	22	12	10
10	14.3	12.9	7.7	22	15	10
11	15.5	14.3	9.3	22	18	10
12	16.8	15.5	9.3	22	23	10
13	18	16.4	9.8	22	23	10
14	19.3	17.9	11	24	30	10

## 2405M / 2405A

12-point Sockets  
12-kant Steckschlüssel  
Douilles 12-pans

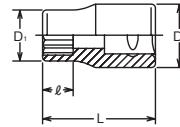

2400A 2405A (inch)	D <sub>1</sub> (mm)	D <sub>2</sub> (mm)	ℓ (mm)	L (mm)	(g)	(pcs.)
1/8	5.7	11.2	2.7	22	7	10
5/32	6.7	11.2	3.5	22	8	10
3/16	7.8	11.2	5	22	8	10
7/32	8.5	11.2	5.5	22	9	10
1/4	9.6	11.2	5.8	22	9	10
9/32	10.3	11.2	6	22	9	10
5/16	11.2	11.7	6.9	22	11	10
11/32	12.5	11.7	7.3	22	12	10
3/8	13.7	12.5	7.7	22	15	10
7/16	15.5	14.3	9.3	22	18	10
1/2	18	16.4	9.8	22	23	10
9/16	19.3	17.9	11	24	30	10

## RS2400M/11 RS2405M/11

Socket Set on Rail  
Steckschlüsselsatz auf Schiene  
Jeu de douilles sur rail



RS2400M/11	11 Pieces Set/Rail 200mm	(g)
4, 5, 6, 7, 8, 9, 10, 11, 12, 13, 14		222

RS2405M/11	11 Pieces Set/Rail 200mm	(g)
4, 5, 6, 7, 8, 9, 10, 11, 12, 13, 14		222

## RS2400A/9 RS2405A/9

Socket Set on Rail  
Steckschlüsselsatz auf Schiene  
Jeu de douilles sur rail



RS2400A/9	9 Pieces Set/Rail 150mm	(g)
3/16, 7/32, 1/4, 9/32, 5/16, 11/32, 3/8, 7/16, 1/2		162

RS2405A/9	9 Pieces Set/Rail 150mm	(g)
3/16, 7/32, 1/4, 9/32, 5/16, 11/32, 3/8, 7/16, 1/2		162

## 2400W-BA

6-point Sockets  
6-kant Steckschlüssel  
Douilles 6-pans

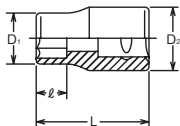

2400W (BA)	D <sub>1</sub> (mm)	D <sub>2</sub> (mm)	ℓ (mm)	L (mm)	(g)	(pcs.)
8	6.1	11.2	3	22	7	10
7	7.3	11.2	4	22	8	10
6	8	11.2	5	22	8	10
5	8.5	11.2	5.5	22	9	10
4	9.6	11.2	5.8	22	9	10
3	10.3	11.2	6	22	9	10
2	11.2	11.7	6.9	22	11	10
1	13	12	7.3	22	12	10
0	14.9	13.6	8	22	16	10

## RS2400W/9-BA

Socket Set on Rail  
Steckschlüsselsatz auf Schiene  
Jeu de douilles sur rail



RS2400W/9-BA	9 Pieces Set/Rail 150mm	(g)
8, 7, 6, 5, 4, 3, 2, 1, 0		120

# 1/4"

Hand Sockets  
Hand Steckschlüssel  
Douilles à main

AS2405A (inch)	D <sub>1</sub> (mm)	D <sub>2</sub> (mm)	ℓ (mm)	L (mm)	(g)	(pcs.)
3/16	7.7	10.9	4.5	22	8	10
7/32	8.5	10.9	4.9	22	8	10
1/4	9.4	10.9	5.3	22	8	10
9/32	10.2	10.9	5.5	22	8	10
5/16	11.3	11.7	6.4	22	10	10
11/32	12.5	12	6.8	22	10	10
3/8	13.7	12.9	6.8	22	13	10
7/16	15.6	14.3	8.8	22	17	10
1/2	17.2	16.4	8.9	22	20	10
9/16	18.8	17.9	9.1	24	27	10

Aerospace Standard SAE AS954

RSAS2405A/10	10 Pieces Set/Rail 150mm	(g)
3/16, 7/32, 1/4, 9/32, 5/16, 11/32, 3/8, 7/16, 1/2, 9/16		160

2410M (mm)	D <sub>1</sub> (mm)	D <sub>2</sub> (mm)	ℓ (mm)	L (mm)	(g)	(pcs.)
4	6.7	11.2	3.5	22	8	10
4.5	7.3	11.2	4	22	8	10
5	8	11.2	5	22	8	10
5.5	8.5	11.2	5.5	22	9	10
6	9.2	11.2	5.5	22	9	10
7	10.3	11.2	6	22	9	10
8	11.2	11.7	6.9	22	11	10
9	13	12	7.3	22	12	10
10	14.3	12.9	7.7	22	15	10
11	15.5	14.3	9.3	22	18	10
12	16.8	15.5	9.3	22	23	10
13	18	16.4	9.8	22	23	10
14	19.3	17.9	11	24	30	10

RS2410M/11	11 Pieces Set/Rail 200mm	(g)
4, 5, 6, 7, 8, 9, 10, 11, 12, 13, 14		222

2415M (mm)	D <sub>1</sub> (mm)	D <sub>2</sub> (mm)	ℓ (mm)	L (mm)	(g)	(pcs.)
New 5.5	10.3	11.2	5.4	22	10	10
6	11	11.7	5.4	22	13	10
New 7	12.5	11.7	6.1	22	13	10
8	14.3	12.9	6.8	22	17	10
10	17.4	16	8.2	22	27	10

2415A (inch)	D <sub>1</sub> (mm)	D <sub>2</sub> (mm)	ℓ (mm)	L (mm)	(g)	(pcs.)
1/4	11	11.7	5.4	22	14	10
5/16	14.3	12.9	6.8	22	17	10
3/8	17.4	16	8.2	22	26	10

2425 (E)	D <sub>1</sub> (mm)	D <sub>2</sub> (mm)	ℓ (mm)	L (mm)	(g)	(pcs.)
E 4	5.4	11.2	4.6	22	7	10
E 5	6.7	11.2	5.2	22	8	10
E 6	7.7	11.2	5.4	22	8	10
E 7	8.3	11.2	6.6	22	9	10
E 8	9.6	11.2	7	22	9	10
E10	11.3	12	8.2	22	10	10
New E11	12.9	12	8.7	22	13	10
New E12	14.3	12.9	9.3	23	17	10

TORX®  
(E)

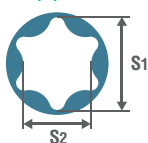

E	E4	E5	E6	E7	E8	E10	E11	E12	E14	E16	E18	E20	E22	E24	E26	E28
S <sub>1</sub> (ref. mm)	3.7	4.6	5.6	6.1	7.4	9.3	9.9	11.0	12.8	14.6	16.5	18.3	20.1	22.0	23.7	25.5
S <sub>2</sub> (ref. mm)	2.7	3.3	4.0	4.3	5.3	6.8	7.1	7.9	9.2	10.5	11.9	13.2	14.8	15.7	17.5	18.3

RS2425/6	6 Pieces Set/Rail 150mm	(g)
E4, E5, E6, E7, E8, E10		90

**AS2405A** 12-point Sockets, AS954  
12-kant Steckschlüssel, AS954  
Douilles 12-pans, AS954

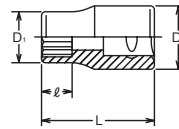

**RSAS2405A/10** Socket Set on Rail  
Steckschlüsselsatz auf Schiene  
Jeu de douilles sur rail



**2410M** Surface Drive Sockets  
Surface Drive Steckschlüssel  
Douilles, Surface Drive

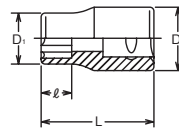

**RS2410M/11** Socket Set on Rail  
Steckschlüsselsatz auf Schiene  
Jeu de douilles sur rail



**2415M / 2415A** Double 4-point Sockets  
Doppelvierkant Steckschlüssel  
Douilles mâles 4-pans doubles

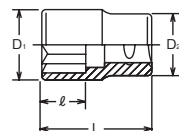

**2425** TORX® Sockets  
TORX® Steckschlüssel  
Douilles TORX®

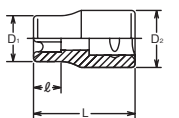

**RS2425/6** Socket Set on Rail  
Steckschlüsselsatz auf Schiene  
Jeu de douilles sur rail



TORX is a registered trademark of Acument Intellectual Properties, LLC.  
TORX ist ein registriertes Markenzeichen der Firma Acument Intellectual Properties, LLC.  
TORX est une marque déposée de Acument Intellectual Properties, LLC.

# Hand Sockets Hand Steckschlüssel 1/4" Douilles à main

Z-SERIES  
HAND  
TITANIUM  
SCREWDRIVERS  
ACCESSORIES  
IMPACT  
SLEEVE-DRIVE  
PROTECTOR  
INDUSTRIAL  
AUTOMOTIVE  
MOTORCYCLE  
CONSTRUCTION  
SPARE PART

## 2450MS Nut Grip Sockets **Nut Grip®** Steckschlüssel mit 2-facher Kugelhalterung Douilles à billes de retenue

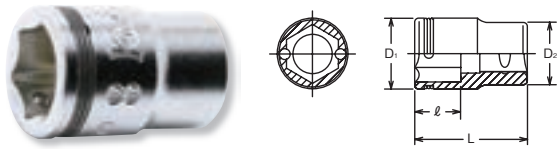

2450MS (mm)	D <sub>1</sub> (mm)	D <sub>2</sub> (mm)	ℓ (mm)	L (mm)	(g)	(pcs.)
7	11.3	11.2	4	18	8	10
8	12.3	11.2	5	18	9	10
10	14.3	12.9	6	19	13	10
12	17.4	16	7	20	22	10
13	18	16.4	8	20	22	10
14	19.9	18	8.5	22	31	10

## RS2450MS/6 Socket Set on Rail Steckschlüsselsatz auf Schiene Jeu de douilles sur rail



RS2450MS/6	6 Pieces Set/Rail 150mm	(g)
7, 8, 10, 12, 13, 14		120

## 2300X 6-point Sockets, Semi-Deep 6-kant Steckschlüssel, mittel-lang Douilles, semi-profondes 6-pans

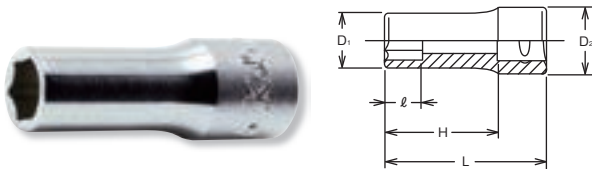

2300X (mm)	D <sub>1</sub> (mm)	D <sub>2</sub> (mm)	ℓ (mm)	H (mm)	L (mm)	(g)	(pcs.)
4	6.7	11.2	4	22	32	10	10
5	8	11.2	5.5	22	32	11	10
6	9.2	11.2	7	22	32	12	10
7	10.5	11.2	8	22	32	13	10
8	11.8	11.2	9	22	32	16	10
9	13	12	10	22	32	18	10
10	14.3	12.9	11	21	32	23	10
11	15.5	14.3	12	21	32	27	10
12	16.8	15.5	13	21	32	29	10
13	18	16.4	14	21	32	32	10
14	19.3	17.9	16	20	32	37	10

## RS2300X/11 Socket Set on Rail Steckschlüsselsatz auf Schiene Jeu de douilles sur rail



RS2300X/11	11 Pieces Set/Rail 200mm	(g)
4, 5, 6, 7, 8, 9, 10, 11, 12, 13, 14		300

## 2350X Nut Grip Socket, Semi-Deep **Nut Grip®** Steckschlüssel mit 2-facher Kugelhalterung, mittel-lang Douilles à billes de retenue, semi-profondes

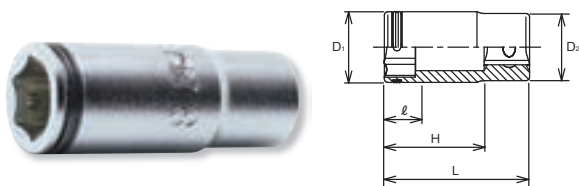

2350X (mm)	D <sub>1</sub> (mm)	D <sub>2</sub> (mm)	ℓ (mm)	H (mm)	L (mm)	(g)	(pcs.)
8	12.3	11.2	5	22	32	17	10
10	14.2	12.9	6	22	32	22	10
12	17.3	16	7	22	32	34	10
14	20	18	8.5	22	32	43	10

## RS2350X/4 Socket Set on Rail Steckschlüsselsatz auf Schiene Jeu de douilles sur rail



RS2350X/4	4 Pieces Set/Rail 150mm	(g)
8, 10, 12, 14		140

2300M 2305M (mm)	D <sub>1</sub> (mm)	D <sub>2</sub> (mm)	ℓ (mm)	H (mm)	L (mm)	(g)	(pcs.)
3	5.5	11.2	3	40	50	15	10
4	6.7	11.2	4	40	50	15	10
4.5	7.3	11.2	4.5	40	50	15	10
5	8	11.2	5.5	40	50	17	10
5.5	8.5	11.2	6	40	50	17	10
6	9.2	11.2	7	40	50	20	10
7	10.5	11.2	8	40	50	25	10
8	11.8	11.2	9	40	50	25	10
9	13	12	10	40	50	30	10
10	14.3	12.9	11	39	50	34	10
11	15.5	14.3	12	39	50	43	10
12	16.8	15.5	13	39	50	50	10
13	18	16.4	14	39	50	52	10
14	19.3	17.9	16	38	50	57	10

2300A 2305A (inch)	D <sub>1</sub> (mm)	D <sub>2</sub> (mm)	ℓ (mm)	H (mm)	L (mm)	(g)	(pcs.)
1/8	5.7	11.2	3.5	40	50	15	10
5/32	6.7	11.2	4	40	50	15	10
3/16	7.8	11.2	5.5	40	50	17	10
7/32	8.5	11.2	6	40	50	17	10
1/4	9.8	11.2	7	40	50	25	10
9/32	10.5	11.2	8	40	50	25	10
5/16	11.8	11.2	9	40	50	25	10
11/32	12.5	11.7	10	40	50	30	10
3/8	13.7	12.5	11	40	50	34	10
7/16	15.5	14.3	12	39	50	43	10
1/2	18	16.4	14	39	50	52	10
9/16	19.3	17.9	16	38	50	57	10

RS2300M/11	11 Pieces Set/Rail 200mm	(g)
4, 5, 6, 7, 8, 9, 10, 11, 12, 13, 14		437

RS2305M/11	11 Pieces Set/Rail 200mm	(g)
4, 5, 6, 7, 8, 9, 10, 11, 12, 13, 14		437

RS2300A/9	9 Pieces Set/Rail 150mm	(g)
3/16, 7/32, 1/4, 9/32, 5/16, 11/32, 3/8, 7/16, 1/2		296

RS2305A/9	9 Pieces Set/Rail 150mm	(g)
3/16, 7/32, 1/4, 9/32, 5/16, 11/32, 3/8, 7/16, 1/2		296

2300W (BA)	D <sub>1</sub> (mm)	D <sub>2</sub> (mm)	ℓ (mm)	H (mm)	L (mm)	(g)	(pcs.)
4	9.8	11.2	7	40	50	22	10
3	10.5	11.2	8	40	50	25	10
2	11.8	11.2	9	40	50	25	10
1	13	12	10	40	50	30	10
0	14.9	13.6	12	39	50	38	10

BA



BA	8BA	7BA	6BA	5BA	4BA	3BA	2BA	1BA	0BA
Across Flat (ref. mm)	3.9	4.4	4.9	5.6	6.3	7.2	8.2	9.3	10.5
(ref. inch)	0.2	0.2	0.2	0.2	0.2	0.3	0.3	0.4	0.4

### 2300M / 2300A

6-point Deep Sockets  
6-kant-Steckschlüssel, lang  
Douilles longues 6-pans

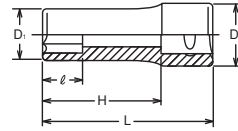

### 2305M / 2305A

12-point Deep Sockets  
12-kant Steckschlüssel, lang  
Douilles longues, 12-pans

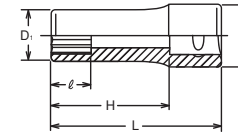

### RS2300M/11

Socket Set on Rail  
Steckschlüsselsatz auf Schiene  
Jeu de douilles sur rail

### RS2305M/11

Socket Set on Rail  
Steckschlüsselsatz auf Schiene  
Jeu de douilles sur rail



### RS2300A/9

Socket Set on Rail  
Steckschlüsselsatz auf Schiene  
Jeu de douilles sur rail

### RS2305A/9

Socket Set on Rail  
Steckschlüsselsatz auf Schiene  
Jeu de douilles sur rail



### 2300W-BA

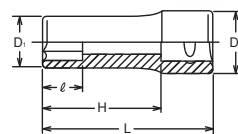

6-point Deep Sockets  
6-kant-Steckschlüssel, lang  
Douilles longues 6-pans



Hand Sockets  
Hand Steckschlüssel  
Douilles à main

# 1/4"

Z-SERIES  
HAND  
TITANIUM  
SCREWDRIVERS ACCESSORIES  
IMPACT  
SLEEVE-DRIVE  
PROTECTOR  
INDUSTRIAL  
AUTOMOTIVE  
MOTORCYCLE  
CONSTRUCTION  
SPARE PART

**AS2305A**  12-point Deep Sockets, AS954  
12-kant Steckschlüssel, lang, AS954  
Douilles longues 12-pans, AS954 

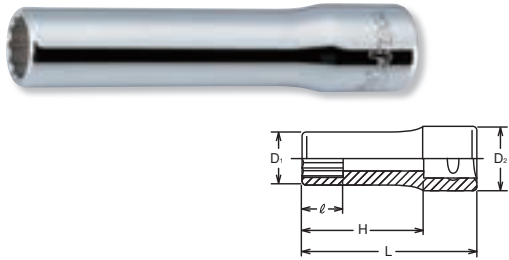

AS2305A (inch)	D <sub>1</sub> (mm)	D <sub>2</sub> (mm)	ℓ (mm)	H (mm)	L (mm)	(g)	(pcs.)
3/16	7.7	10.9	4.5	40	50	17	10
7/32	8.5	10.9	4.9	40	50	17	10
1/4	9.4	10.9	5.3	40	50	19	10
9/32	10.2	10.9	5.5	40	50	18	10
5/16	11.3	11.7	6.4	40	50	23	10
11/32	12.5	12	6.8	40	50	24	10
3/8	13.7	12.8	6.8	39	50	31	10
7/16	15.6	14.2	8.8	39	50	38	10
1/2	17.2	16.2	8.9	39	50	42	10
9/16	18.8	17.1	9.1	38	50	47	10

Aerospace Standard SAE AS954

**RSAS2305A/10**  Socket Set on Rail  
Steckschlüsselsatz auf Schiene  
Jeu de douilles sur rail 



RSAS2305A/10	10 Pieces set/Rail 150mm	(g)
3/16, 7/32, 1/4, 9/32, 5/16, 11/32, 3/8, 7/16, 1/2, 9/16		307

**2310M**  Surface Drive Deep Sockets  
Surface Drive Steckschlüssel, lang  
Douilles longues, Surface Drive

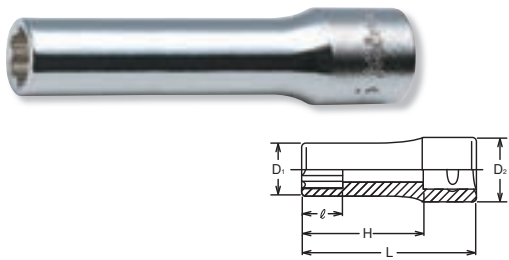

2310M (mm)	D <sub>1</sub> (mm)	D <sub>2</sub> (mm)	ℓ (mm)	H (mm)	L (mm)	(g)	(pcs.)
3	5.5	11.2	3	40	50	15	10
4	6.7	11.2	4	40	50	15	10
4.5	7.3	11.2	4.5	40	50	15	10
5	8	11.2	5.5	40	50	17	10
5.5	8.5	11.2	6	40	50	17	10
6	9.2	11.2	7	40	50	20	10
7	10.5	11.2	8	40	50	25	10
8	11.8	11.2	9	40	50	25	10
9	13	12	10	40	50	30	10
10	14.3	12.9	11	39	50	34	10
11	15.5	14.3	12	39	50	43	10
12	16.8	15.5	13	39	50	50	10
13	18	16.4	14	39	50	52	10
14	19.3	17.9	16	38	50	57	10

**RS2310M/11**  Socket Set on Rail  
Steckschlüsselsatz auf Schiene  
Jeu de douilles sur rail



RS2310M/11	11 Pieces set/Rail 200mm	(g)
4, 5, 6, 7, 8, 9, 10, 11, 12, 13, 14		437

**2325**  TORX® Deep Sockets  
TORX® Steckschlüssel, lang  
Douilles longues TORX®

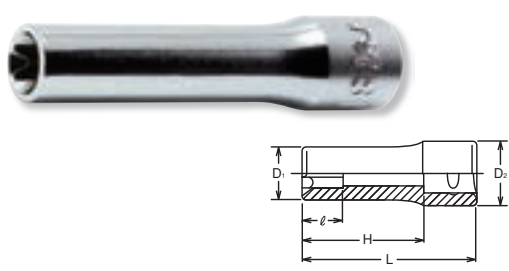

2325 (E)	D <sub>1</sub> (mm)	D <sub>2</sub> (mm)	ℓ (mm)	H (mm)	L (mm)	(g)	(pcs.)
E 4	5.4	12	4.6	40	50	17	10
E 5	6.8	12	5.2	40	50	20	10
E 6	8	12	5.4	40	50	20	10
E 7	8.3	12	6.6	40	50	22	10
E 8	9.8	12	7	40	50	25	10
E10	11.6	12	8.2	40	50	29	10

2350M (mm)	D <sub>1</sub> (mm)	D <sub>2</sub> (mm)	ℓ (mm)	H (mm)	L (mm)	(g)	(pcs.)
8	12.3	11.2	5	40	50	30	10
10	14.2	12.9	6	39	50	35	10
12	17.3	16	7	39	50	55	10
14	19.9	18	8.5	38	50	70	10



## NUT GRIP®

Twin balls at the 6-point opening hold bolt/nut tightly for safe and reliable work.

Die zwei Kugeln in der 6-kant Öffnung unserer NUT GRIP Steckschlüssel halten die Schraube sicher im Steckschlüssel. Dies erlaubt ein Arbeiten auch an schwer zugänglichen Stellen.

Les 2 billes dans l'ouverture du 6-pan de la douille retiennent l'écrou de manière sûre et efficace.

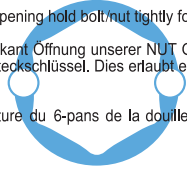

RS2350M/4	4 Pieces Set/Rail 150mm	(g)
<b>New</b>	<b>8, 10, 12, 14</b>	<b>220</b>

2440M 2445M (mm)	D <sub>1</sub> (mm)	D <sub>2</sub> (mm)	ℓ (mm)	L (mm)	(g)	(pcs.)
4	6.7	13	4.8	31.5	17	10
5	8	13	5.3	32	17	10
6	9.2	13	6.1	33	18	10
7	10.5	13	6.5	33	19	10
8	11.7	13	7	34	19	10
9	13	13	7	34	20	10
10	14.2	13	8.3	35	20	10
11	15.5	13	9.5	36	21	10
12	16.7	13	10	37	21	10
13	18	13	10.5	37	26	10
14	19.2	13	10.5	37	28	10

2440A (inch)	D <sub>1</sub> (mm)	D <sub>2</sub> (mm)	ℓ (mm)	L (mm)	(g)	(pcs.)
1/4	9.8	13	6.5	33	18	10
5/16	11.7	13	7	34	19	10
3/8	13.7	13	8.3	35	20	10
7/16	15.5	13	9.5	36	21	10
1/2	18	13	10.5	37	26	10
9/16	19.2	13	10.5	37	28	10

2445A (inch)	D <sub>1</sub> (mm)	D <sub>2</sub> (mm)	ℓ (mm)	L (mm)	(g)	(pcs.)
3/16	8	13	5.3	32	18	10
1/4	9.8	13	6.5	33	18	10
9/32	10.5	13	6.5	33	19	10
5/16	11.7	13	7	34	19	10
11/32	13	13	7	34	20	10
3/8	13.7	13	8.3	35	20	10
7/16	15.5	13	9.5	36	21	10
1/2	18	13	10.5	37	26	10
9/16	19.2	13	10.5	37	28	10

RS2445A/9	9 Pieces set/Rail 150mm	(g)
<b>3/16, 1/4, 9/32, 5/16, 11/32, 3/8, 7/16, 1/2, 9/16</b>		<b>220</b>

AS2445A (inch)	D <sub>1</sub> (mm)	D <sub>2</sub> (mm)	ℓ (mm)	L (mm)	(g)	(pcs.)
1/4	9.6	12.9	5.7	31.8	18	10
5/16	11.7	12.9	7	34.6	21	10
3/8	13.5	12.9	8.3	35.1	21	10
7/16	15.5	12.9	9.5	39.1	25	10
1/2	17.2	12.9	10.5	40.1	27	10

**2350M** Nut Grip Deep Sockets **Nut Grip®**  
Steckschlüssel mit 2-facher Kugelhalterung, lang  
Douilles longues à billes de retenue

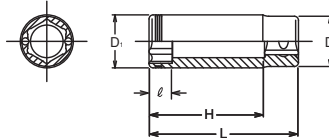

**RS2350M/4** Socket Set on Rail  
Steckschlüsselsatz auf Schiene  
Jeu de douilles sur rail



**2440M / 2440A** 6-point Universal Sockets  
6-kant Gelenk-Einsätze  
Douilles universelles, 6-pan

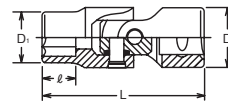

**2445M / 2445A** 12-point Universal Sockets  
12-kant Gelenk-Einsätze  
Douilles universelles, 12-pan

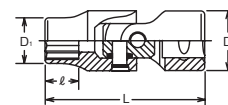

**RS2445A/9** Socket Set on Rail  
Steckschlüsselsatz auf Schiene  
Jeu de douilles sur rail



**AS2445A** 12-point Universal Sockets  
12-kant Gelenk-Einsätze  
Douilles universelles, 12-pan

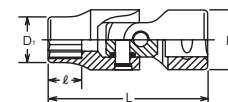

# Hand Sockets Hand Steckschlüssel 1/4"

Z-SERIES

HAND

TITANIUM

SCREWDRIVERS ACCESSORIES

IMPACT

SLEEVE-DRIVE

PROTECTOR

INDUSTRIAL

AUTOMOTIVE

MOTORCYCLE

CONSTRUCTION

SPARE PART

## 2440T TORX® Universal Sockets TORX® Gelenk-Einsätze Douilles universelles TORX®

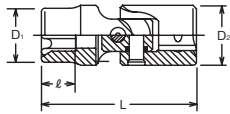

2440T (E)	D <sub>1</sub> (mm)	D <sub>2</sub> (mm)	l (mm)	L (mm)	(g)	(pcs.)
E 6	8	13	5.4	31.9	20	10
E 8	9.8	13	7	33.1	20	10
E10	11.7	13	8.2	33.6	21	10
E12	14.2	13	9.3	35.1	24	10

## 2441M Nut Grip Universal Sockets Nut Grip® Gelenk-Einsätze mit zweifacher Kugelhalterung Douilles universelles à billes de retenue

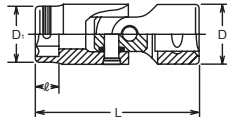

2441M (mm)	D <sub>1</sub> (mm)	D <sub>2</sub> (mm)	l (mm)	L (mm)	(g)	(pcs.)
7	11.3	13	4	33	19	10
8	12.3	13	5	32	19	10
10	14.5	13	6	32.5	21	10
12	16.8	13	7	34	21	10
13	18	13	8	35	21	10
14	20	13	8.5	37	28	10

## 2430M Universal Hex Sockets Gelenk-Einsätze für Schrauben mit Innensechskant Douilles universelles, 6-pans mâles

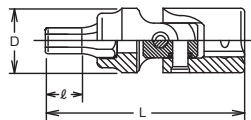

2430M (mm)	D (mm)	l (mm)	L (mm)	(g)	(pcs.)
3	13	5.5	40	18	10
4	13	5.5	40	18	10
5	13	6.5	40	20	10
6	13	7.5	40	21	10

## 2430T TORX® Universal Sockets TORX® Gelenk-Einsätze Douilles universelles TORX®

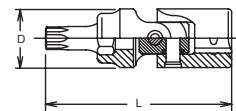

2430T (T)	D (mm)	L (mm)	(g)	(pcs.)
T 8	13	42	22	10
T 9	13	42	22	10
T10	13	42	22	10
T15	13	42	22	10
T20	13	42	22	10
T25	13	42	22	10
T27	13	42	22	10
T30	13	42	22	10

## 2000-28 (PH) Phillips Bit Sockets Steckschlüssel für Kreuzschlitzschrauben, Phillips Douilles tournevis pour vis à empreinte Phillips

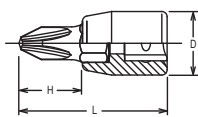

2000-28 (PH)	D (mm)	H (mm)	L (mm)	(g)	(pcs.)
1	11.9	12	28	10	10
2	11.9	12	28	11	10
3	11.9	12	28	12	10
4	13.1	11	28	14	10

## 2000-28 (PZ) PZ Bit Sockets Steckschlüssel für Kreuzschlitzschrauben, PZ Douilles tournevis pour vis à empreinte PZ

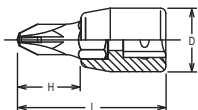

2000-28 (PZ)	D (mm)	H (mm)	L (mm)	(g)	(pcs.)
PZ1	11.9	12	28	10	10
PZ2	11.9	12	28	11	10
PZ3	11.9	12	28	12	10

## 2005-25 Bit Sockets for Slotted Head Steckschlüssel für Schlitzschrauben Douilles tournevis pour vis à fente

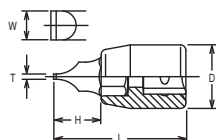

2005-25	T×W (mm)	D (mm)	H (mm)	L (mm)	(g)	(pcs.)
3	0.5× 3	11.9	9	25	9	10
4	0.8× 4	11.9	9	25	10	10
5	1.0× 5.5	11.9	9	25	10	10
6	1.2× 6.5	13.1	9	25	11	10
8	1.2× 8	13.1	9	25	12	10
9	1.6× 8	13.1	9	25	12	10
10	1.6×10	14.3	9	25	13	10



2010M-25 (mm)	D (mm)	H (mm)	L (mm)	(g)	(pcs.)
1.5	11.9	9	25	9	10
2	11.9	9	25	9	10
2.5	11.9	9	25	9	10
3	11.9	9	25	9	10
4	11.9	9	25	9	10
5	11.9	9	25	10	10
6	11.9	9	25	12	10
7	13.1	8	25	12	10
8	13.1	8	25	14	10
10	14.3	8	25	17	10
New 12	16.4	8	25	36	10

2010M-100 (mm)	D (mm)	H (mm)	L (mm)	(g)	(pcs.)
2	11.9	84	100	30	10
2.5	11.9	84	100	30	10
3	11.9	84	100	30	10
4	11.9	84	100	30	10
5	13.1	83	100	30	10
6	13.1	83	100	35	10
7	13.1	83	100	35	10
8	13.1	83	100	38	10
10	14.3	83	100	45	10
New 12	16.4	83	100	107	10

2010A-25 (inch)	D (mm)	H (mm)	L (mm)	(g)	(pcs.)
1/8	11.9	9	25	9	10
5/32	11.9	9	25	9	10
3/16	11.9	9	25	10	10
7/32	11.9	9	25	11	10
1/4	11.9	9	25	12	10
9/32	13.1	8	25	12	10
5/16	13.1	8	25	14	10
3/8	14.3	8	25	17	10

RS2010M/7-L25	7 Pieces set/Rail 150mm	(g)
3, 4, 5, 6, 7, 8, 10		115

RS2010A/8-L25	8 Pieces set/Rail 150mm	(g)
1/8, 5/32, 3/16, 7/32, 1/4, 9/32, 5/16, 3/8		130

2011M-50 (mm)	D (mm)	H (mm)	L (mm)	(g)	(pcs.)
3	11.9	34	50	16	10
4	11.9	34	50	17	10
5	11.9	34	50	18	10
6	11.9	34	50	18	10

⚠ Ball point bit sockets have less strength due to the special design. Make sure to use them correctly.



2020-28 (XZN)	D (mm)	H (mm)	L (mm)	(g)	(pcs.)
M4	11.9	12	28	12	10
M5	11.9	12	28	12	10
M6	11.9	12	28	13	10
M8	13.1	11	28	14	10

2020-50 (XZN)	D (mm)	H (mm)	L (mm)	(g)	(pcs.)
M4	11.9	34	50	20	10
M5	11.9	34	50	20	10
M6	11.9	34	50	22	10
M8	13.1	33	50	24	10

### 2010M-25/-100 2010A-25

● Inhex Bit Sockets  
Steckschlüssel für Innensechskant-Schrauben  
Douilles tournevis pour vis 6-pans creux

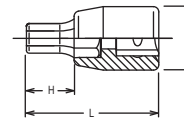

### RS2010M/7-L25 RS2010A /8-L25

● Socket Set on Rail  
Steckschlüsselsatz auf Schiene  
Jeu de douilles sur rail

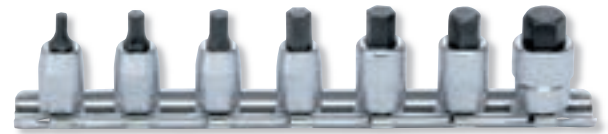

### 2011M-50

● Ballpoint Inhex Sockets  
Steckschlüssel mit Kugelkopf, für Innensechskant-Schrauben ⚠  
Douilles tournevis avec tête sphérique pour vis 6-pans creux

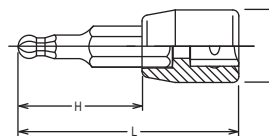

### 2020-28/-50

● XZN Bit Sockets  
Steckschlüssel für XZN Schrauben  
Douilles tournevis pour empreinte XZN

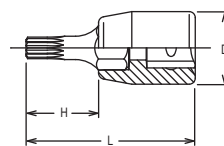

Z-SERIES  
HAND  
TITANIUM  
ACCESSORIES  
IMPACT  
SLEEVE-DRIVE  
PROTECTOR  
INDUSTRIAL  
AUTOMOTIVE  
MOTORCYCLE  
CONSTRUCTION  
SPARE PART

## 2025-28/-80 (T)

 TORX® Bit Sockets  
TORX® Bit-Steckschlüssel  
Douilles tournevis, TORX®

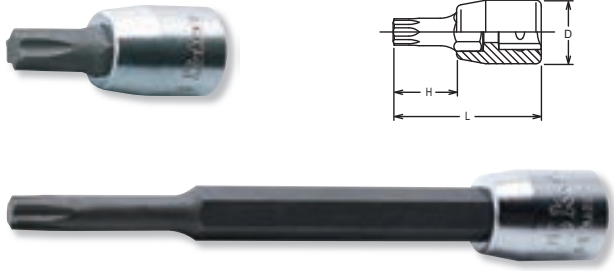

2025-28 (T)	D (mm)	H (mm)	L (mm)	(g)	(pcs.)
T 8	11.9	12	28	10	10
T 9	11.9	12	28	10	10
T10	11.9	12	28	10	10
T15	11.9	12	28	10	10
T20	11.9	12	28	11	10
T25	11.9	12	28	11	10
T27	11.9	12	28	12	10
T30	11.9	12	28	12	10
T40	11.9	12	28	13	10

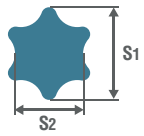

2025-80 (T)	D (mm)	H (mm)	L (mm)	(g)	(pcs.)
T10	11.9	64	80	40	10
T15	11.9	64	80	40	10
T20	11.9	64	80	42	10
T25	11.9	64	80	42	10
T27	11.9	64	80	45	10
T30	11.9	64	80	45	10
T40	11.9	64	80	50	10

### TORX® (T)



T	T8	T9	T10	T15	T20	T25	T27	T30	T40	T45	T50	T55	T60	T70	T80	T90	T100
S <sub>1</sub> (ref. mm)	2.3	2.5	2.7	3.3	3.9	4.5	5.0	5.6	6.7	7.9	8.9	11.3	13.3	15.6	17.6	20.0	22.2
S <sub>2</sub> (ref. mm)	1.7	1.8	2.0	2.3	2.8	3.2	3.6	4.0	4.8	5.6	6.2	8.0	9.5	11.1	12.7	14.2	15.8

## RS2025/7-L28

  Socket Set on Rail  
Steckschlüsselsatz auf Schiene  
Jeu de douilles sur rail



RS2025/7-L28	7 Pieces set/Rail 150mm	(g)
T10, T15, T20, T25, T27, T30, T40		119

## 2025-28 (TH)



 Tamper-Resistant TORX® Bit Sockets  
Tamper-Resistant TORX® Bit-Steckschlüssel  
Douilles tournevis, Tamper-Resistant TORX® 



2025-28 (TH)	D (mm)	H (mm)	L (mm)	(g)	(pcs.)
T10H	11.9	12	28	10	10
T15H	11.9	12	28	10	10
T20H	11.9	12	28	11	10
T25H	11.9	12	28	11	10
T27H	11.9	12	28	12	10
T30H	11.9	12	28	12	10
T40H	11.9	12	28	13	10

 Tamper Resistant TORX® Bit Sockets have less strength due to their special design. Make sure to use it correctly.

## RS2025/7-L28 (TH)

  Socket Set on Rail  
Steckschlüsselsatz auf Schiene  
Jeu de douilles sur rail



RS2025/7-HOLE	7 Pieces set/Rail 150mm	(g)
T10H, T15H, T20H, T25H, T27H, T30H, T40H		119



2025-28 (IP)	D (mm)	H (mm)	L (mm)	(g)	(pcs.)
8IP	11.9	12	28	10	10
9IP	11.9	12	28	10	10
10IP	11.9	12	28	10	10
15IP	11.9	12	28	10	10
20IP	11.9	12	28	11	10
25IP	11.9	12	28	11	10
27IP	11.9	12	28	12	10
30IP	11.9	12	28	12	10
40IP	11.9	12	28	13	10

## 2025-28 (IP)



TORXPLUS® Bit Sockets  
TORXPLUS® Bit-Steckschlüssel  
Douilles tournevis, TORXPLUS®

**TORXplus**

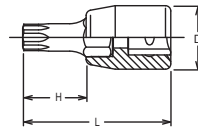

### TORXPLUS® (IP)

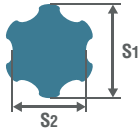

IP		8IP	9IP	10IP	15IP	20IP	25IP	27IP	30IP	40IP	45IP	50IP	55IP	60IP	70IP
S <sub>1</sub>	(ref. mm)	2.3	2.5	2.7	3.3	3.9	4.5	5.0	5.6	6.7	7.9	8.9	11.3	13.3	15.6
S <sub>2</sub>	(ref. mm)	1.7	1.8	2.0	2.3	2.8	3.2	3.6	4.0	4.8	5.6	6.2	8.0	9.5	11.1

RS2025/7-L28 (IP)	7 Pieces set/Rail 150mm	(g)
10IP, 15IP, 20IP, 25IP, 27IP, 30IP, 40IP		120

## RS2025/7-L28 (IP)



Socket Set on Rail  
Steckschlüsselsatz auf Schiene  
Jeu de douilles sur rail



2025-28 (IPR)	D (mm)	H (mm)	L (mm)	(g)	(pcs.)
8IPR	11.9	12	28	10	10
9IPR	11.9	12	28	10	10
10IPR	11.9	12	28	10	10
15IPR	11.9	12	28	10	10
20IPR	11.9	12	28	11	10
25IPR	11.9	12	28	11	10
27IPR	11.9	12	28	12	10
30IPR	11.9	12	28	12	10
40IPR	13.1	12	28	13	10

## 2025-28 (IPR)



TORXPLUS® Bit Sockets, with hole  
TORXPLUS® Bit-Steckschlüssel mit Stirnbohrung  
douilles tournevis TORXPLUS® avec trou

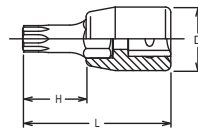

### TORXPLUS® (IPR)

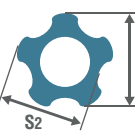

IPR		8IPR	9IPR	10IPR	15IPR	20IPR	25IPR	27IPR	30IPR	40IPR	45IPR	50IPR	55IPR
S <sub>1</sub>	(ref. mm)	2.2	2.4	2.6	3.1	3.6	4.1	4.7	5.2	6.3	7.4	8.4	10.6
S <sub>2</sub>	(ref. mm)	2.0	2.2	2.4	2.8	3.3	3.8	4.3	4.8	5.7	6.7	7.6	9.7

RS2025/7-L28 (IPR)	7 Pieces set/Rail 150mm	(g)
10IPR, 15IPR, 20IPR, 25IPR, 27IPR, 30IPR, 40IPR		120

## RS2025/7-L28 (IPR)



Socket Set on Rail  
Steckschlüsselsatz auf Schiene  
Jeu de douilles sur rail



2137	1/4"	D <sub>1</sub> (mm)	D <sub>2</sub> (mm)	L (mm)	(g)	(pcs.)
2137	1/4"	12	12	22.5	13	10

For DIN3126 C6.3 Bits  
Für DIN3126 C6.3 Bits  
Pour DIN3126 C6.3 Embouts

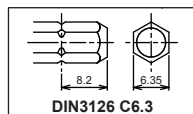

## 2137



Bit Holder  
Klingenhalter  
Porte-embouts

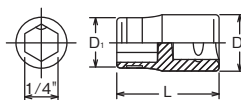

2138	1/4"	D <sub>1</sub> (mm)	D <sub>2</sub> (mm)	L (mm)	(g)	(pcs.)
2138	1/4"	16	16	26	32	10

For DIN3126 C8 Bits  
Für DIN3126 C8 Bits  
Pour DIN3126 C8 Embouts

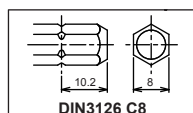

## 2138



Bit Holder  
Klingenhalter  
Porte-embouts

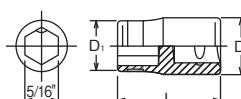

# Hand Sockets Hand Steckschlüssel Douilles à main

## 1/4"

Z-SERIES  
HAND  
TITANIUM  
SCREWDRIVERS ACCESSORIES  
IMPACT  
SLEEVE-DRIVE  
PROTECTOR  
INDUSTRIAL  
AUTOMOTIVE  
MOTORCYCLE  
CONSTRUCTION  
SPARE PART

**2753PS** Reversible Ratchet (Short)  
Knarre kurz, verstellbar  
Cliquet courte, réversible

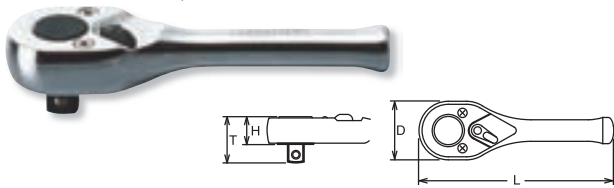

\* Renewal Kits → 2753RK → P298

	D (mm)	T (mm)	H (mm)	L (mm)	(g)	(pcs.)
2753PS	22	18.7	11.4	75	55	5

**2753J** Reversible Ratchet  
Knarre, verstellbar  
Cliquet, réversible



\* Renewal Kits → 2753RK → P298

	D (mm)	T (mm)	H (mm)	L (mm)	(g)	(pcs.)
2753J	22	18.7	11.4	115	77	5

**2753P** Reversible Ratchet  
Knarre, verstellbar  
Cliquet, réversible



\* Renewal Kits → 2753RK → P298

	D (mm)	T (mm)	H (mm)	L (mm)	(g)	(pcs.)
2753P	22	18.7	11.4	115	87	10

**2753N** Reversible Ratchet  
Knarre, verstellbar  
Cliquet, réversible

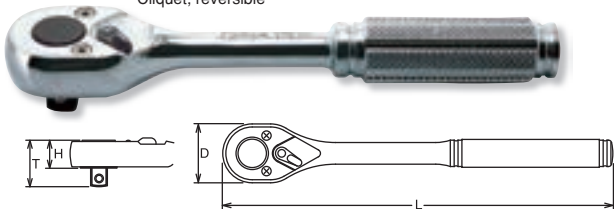

\* Renewal Kits → 2753RK → P298

	D (mm)	T (mm)	H (mm)	L (mm)	(g)	(pcs.)
2753N	22	18.7	11.4	115	90	10

**2753P-160** Reversible Ratchet (Long)  
Verstellbare Knarre, lang  
Cliquet réversible, longue

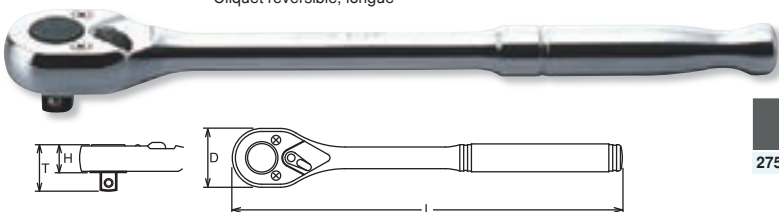

\* Renewal Kits → 2753RK → P298

	D (mm)	T (mm)	H (mm)	L (mm)	(g)	(pcs.)
2753P-160	22	18.7	11.4	160	107	5

**2753JB** Reversible Ratchet with quick release button  
Knarre, verstellbar mit Verriegelungsknopf  
Cliquet, réversible avec bouton de débrayage



\* Renewal Kits → 2753BRK → P298

**2753PB** Reversible Ratchet with quick release button  
Knarre, verstellbar mit Verriegelungsknopf  
Cliquet, réversible avec bouton de débrayage



\* Renewal Kits → 2753BRK → P298

**2753NB** Reversible Ratchet with quick release button  
Knarre, verstellbar mit Verriegelungsknopf  
Cliquet, réversible avec bouton de débrayage

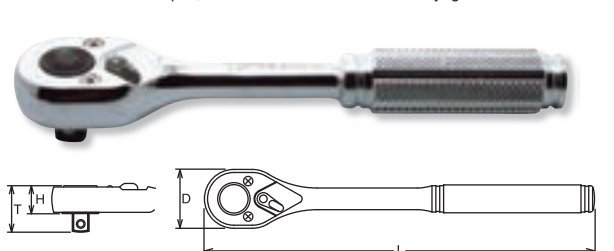

\* Renewal Kits → 2753BRK → P298

	D (mm)	T (mm)	H (mm)	L (mm)	(g)	(pcs.)
2753JB	22	18.7	11.4	115	77	5
2753PB	22	18.7	11.4	115	87	10
2753NB	22	18.7	11.4	115	90	10

**⚠ Reversible Ratchet with Quick Release Button :**  
Sockets and accessories are safely locked. By pushing the button the sockets or extension bars are released from the ratchet.

**Umstellbare Knarre mit Verriegelungsknopf :**  
Steckschlüssel und Zubehörteile werden sicher und fest gehalten. Bei Drücken des Knopfes lösen sich die Teile.

**Cliquet réversible à verrouillage :**  
Les douilles et accessoires ne peuvent plus tomber. Une pression du pouce sur le bouton suffit pour les libérer.



\* Renewal Kits → 2753RK → P298



\* Renewal Kits → 2753RK → P298

	D (mm)	T (mm)	H (mm)	L (mm)	(g)	(pcs.)
2774JS	22	18.7	11.4	116	113	5
2774PS	22	18.7	11.4	116	110	5



\* Renewal Kits → 2753RK → P298



\* Renewal Kits → 2753RK → P298



\* Renewal Kits → 2753RK → P298

	D (mm)	T (mm)	H (mm)	L (mm)	(g)	(pcs.)
2774J	22	18.7	11.4	161	130	2
2774P	22	18.7	11.4	161	126	2
2774N	22	18.7	11.4	161	130	2



\* Renewal Kits → 2755RK → P300

	D (mm)	L (mm)	(g)	(pcs.)
2755	26	40	80	10

	D (mm)	L (mm)	(g)	(pcs.)
2756	22	20	19	10

**2774JS** Flexible Ratchet, reversible  
Gelenk-Knarre, verstellbar  
Cliquet articulé, réversible



**2774PS** Flexible Ratchet, reversible  
Gelenk-Knarre, verstellbar  
Cliquet articulé, réversible

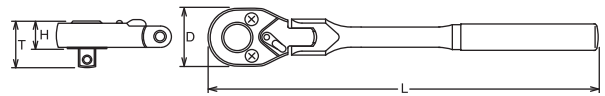

**2774J** Flexible Ratchet, reversible  
Gelenk-Knarre, verstellbar  
Cliquet articulé, réversible

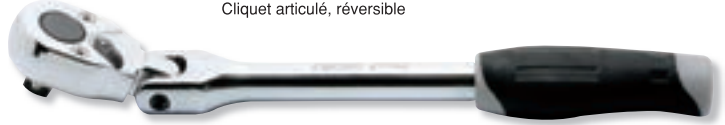

**2774P** Flexible Ratchet, reversible  
Gelenk-Knarre, verstellbar  
Cliquet articulé, réversible



**2774N** Flexible Ratchet, reversible  
Gelenk-Knarre, verstellbar  
Cliquet articulé, réversible

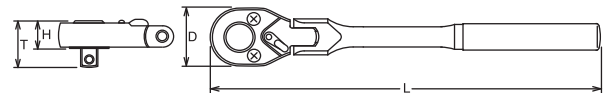

**2755** Ratchet Adaptor  
Aufsteckknarre  
Cliquet adaptable

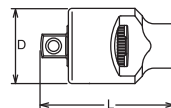

**2756** Quick Spinner  
Rändel-Drehscheibe  
Lanceur

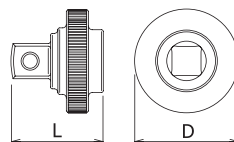

Z-SERIES  
HAND  
TITANIUM  
SCREWDRIVERS ACCESSORIES  
IMPACT  
SLEEVE-DRIVE  
PROTECTOR  
INDUSTRIAL  
AUTOMOTIVE  
CONSTRUCTION MOTORCYCLE  
SPARE PART

## 2760-28/-50/-75/-100/-150/-200/-250/ -300/-350/-400/-600

Extension Bars  
Verlängerungen  
Rallonges

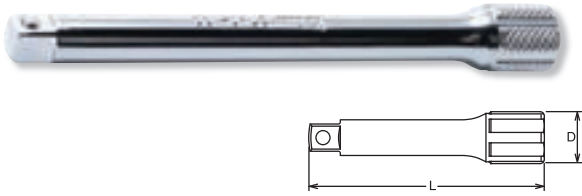

### PK2760/6

Extension Set in Plastic Box  
Verlängerungen in Kunststoffkassette  
Jeu de rallonges en boîte plastique



2760	D (mm)	L (mm)	(g)	(pcs.)
28	12.3	28	14	10
50	12.3	50	23	10
75	12.3	75	35	10
100	12.3	100	44	10
150	12.3	150	63	10
200	12.3	200	83	10
250	12.3	250	103	10
300	12.3	300	122	2
350	12.3	350	145	2
400	12.3	400	160	2
600	12.3	600	240	2

PK2760/6 6 Pieces Set/△=430g

PLASTIC TRAY

Extension Bars

2760 Extension Bars  
28, 50, 100, 150, 200, 250

Rotation and general handling of extensions with oily hands is greatly improved with the **Koken** developed 6 point knurling. Also the **Koken** 6 point knurling stops the extensions from rolling around the work area.

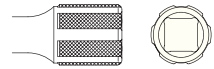

Durch die von **Koken** entwickelte 6 fache Rändelung wird die Handhabung deutlich erleichtert. Außerdem wird das Herumrollen der Verlängerungen wirksam verhindert.

La manipulation des rallonges est grandement facilitée par le profil moleté développé par **Koken**. Ce même profil empêche le roulement intempestif des rallonges sur le plan de travail.

## 2763-28/-50/-75/-100/-150/ -200/-250



Wobble-Fix Extension Bars  
Winkel-Verlängerungen  
Rallonges angulaires

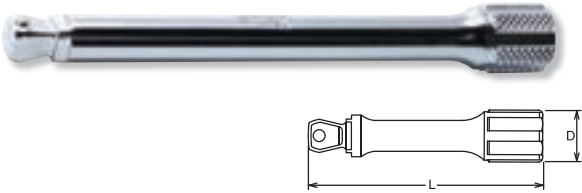

### PK2763/6

Wobble-Fix Extension Bars in Plastic Box  
Winkel-Verlängerungen in Kunststoffkassette  
Jeu de rallonges angulaires en boîte plastique



2763	D (mm)	L (mm)	(g)	(pcs.)
28	12.3	28	14	10
50	12.3	50	23	10
75	12.3	75	33	10
100	12.3	100	43	10
150	12.3	150	62	10
200	12.3	200	80	10
250	12.3	250	100	10

PK2763/6 6 Pieces Set/△=420g

PLASTIC TRAY

Extension Bars

2763 Wobble-Fix Extension Bars  
28, 50, 100, 150, 200, 250

#### Wobble-Fix Extension Bar

Two way usage

- In a fixed position, as a normal extension bar
- In a half-fixed position, as a flexible extension bar providing a 15° angle operation

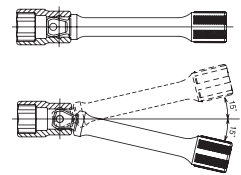

#### Winkel-Verlängerungen

Winkelverlängerungen lassen sich in zwei Einstellungen verwenden

- voll eingesteckt und starr,
- halb eingesteckt, mit einem Arbeitswinkel von 15°.

#### Rallonges angulaires

Deux utilisations possibles

- comme rallonge normale, dans une position fixe
- comme une rallonge angulaire avec une possibilité d'inclinaison jusqu'à 15°

⚠ The Wobble-Fix Extension Bar has less strength than normal extension bar due to it's specific design with a reduced square drive. Make sure to use it correctly.

## 2762

Flexible Extension Bar  
Biegsame Verlängerung  
Rallonge flexible

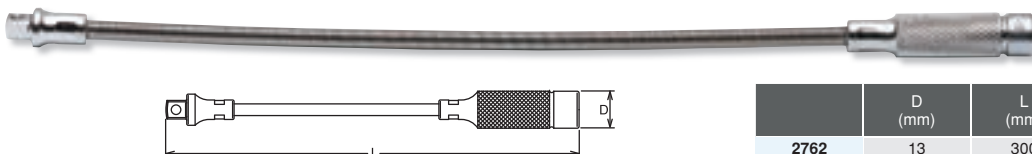

2762	D (mm)	L (mm)	(g)	(pcs.)
2762	13	300	90	2

## 2120

Magnetic Head  
Magnetkopf  
Tête aimantée

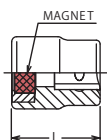

2120	L (mm)	(g)	(pcs.)
2120	17.5	21	10

\* Renewal Kits → 2768RK → P300

	D (mm)	L (mm)	(g)	(pcs.)
2768J	14	130	73	5
2768P	14	130	70	10

\* Renewal Kits → 2768RK → P300

2769N	ℓ (mm)	L (mm)	(g)	(pcs.)
150	50	150	68	2
220	120	220	100	2



Plastic or rubber handles are not intended to act as insulation.

Plastik-oder Gummigriffe stellen keinen Isolierschutz dar.

Les poignées en plastique ou en caoutchouc ne garantissent aucune isolation électrique.



2769NWF	ℓ (mm)	L (mm)	(g)	(pcs.)
150	50	150	68	2
220	120	220	100	2

**2768J** Hinge Handle  
Gelenkgriff  
Poignée articulée



**2768P** Hinge Handle  
Gelenkgriff  
Poignée articulée

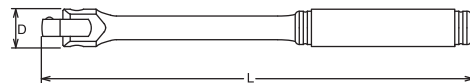

**2769N-150/-220** Spin Type Handle  
Drehgriff  
Poignée emmanchée

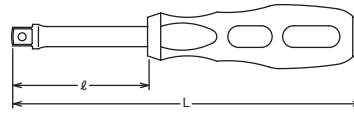

**2769NWF-150/-220**

Spin Type Handle (Wobble-Fix)  
Drehgriff, Wobble-Fix  
Poignée emmanchée, angulaire

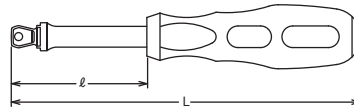

**2769H** Folding Socket Driver  
Klapp-Drehgriff  
Poignée tournevis articulée

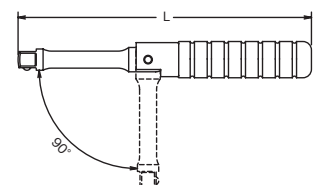

	L (mm)	(g)	(pcs.)
2769H	160	180	10

Hand Sockets  
Hand Steckschlüssel  
Douilles à main

# 1/4"

Z-SERIES  
HAND  
TITANIUM  
SCREWDRIVERS ACCESSORIES  
IMPACT  
SLEEVE-DRIVE  
PROTECTOR  
INDUSTRIAL  
AUTOMOTIVE  
MOTORCYCLE  
CONSTRUCTION  
SPARE PART

**2770** Universal Joint  
Gelenk-Einsatz  
Cardan universel

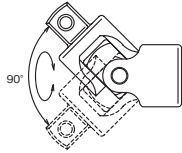
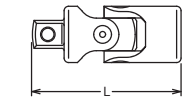

	L (mm)	(g)	(pcs.)
2770	33	20	10
2771	31	20	10

**2771** Universal Joint  
Gelenk-Einsatz  
Joint articlé

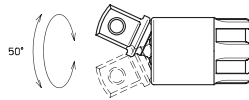
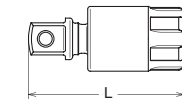

**2780** Speed Handle  
Winde  
Vilebrequin

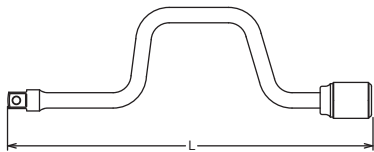

	L (mm)	(g)	(pcs.)
2780	350	250	1

**2785** T-Handle  
T-Griff  
Poignée coulissante

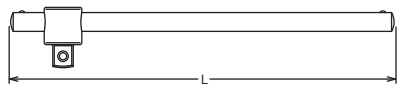

	L (mm)	(g)	(pcs.)
2785	115	36	10



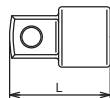

**2233A** Adaptor  
Verbindungsstück  
Augmentateur



	(sq.)	(sq.)	L (mm)	(g)	(pcs.)
2233A	1/4"	3/8"	22	16	10





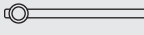







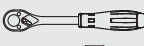

<b>ESH2001</b> 16 Pieces Set/△△=630g	
METAL CASE:W160×H100×T28mm	
Sockets	Accessories
 <b>2410M</b> Surface Drive Sockets 4, 5, 5.5, 6, 7, 8, 9, 10, 11, 12, 13	 <b>2753J</b>  <b>2763-50</b>  <b>2760-150</b>  <b>2770</b>  <b>2785</b>

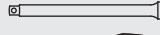



**ESH2001** Socket Set  
Steckschlüssel Satz  
Jeu de clés à douille



<b>ENH2003</b> 26 Pieces Set/△△=980g	
METAL CASE:W310×H86×T40mm	
Sockets	Accessories
 <b>2400M</b> 6-pt. Sockets 5.5, 6, 7, 8, 9, 10, 11, 12, 13, 14  <b>108P</b> Phillips Bits 1, 2  <b>108S</b> Slotted Bits 4, 6, 8  <b>108H</b> Hex Bits 3, 4, 5, 6	 <b>2753J</b>  <b>2760-50</b>  <b>2760-150</b>  <b>2769N-150</b>  <b>2770</b>  <b>2785</b>  <b>2137</b>



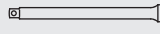
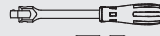

**ENH2003** Socket Set  
Steckschlüssel Satz  
Jeu de clés à douille





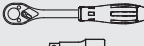

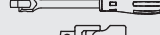

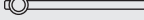

<b>2251M</b> 17 Pieces Set/△△=725g	
METAL CASE:W192×H122×T30mm	
Sockets	Accessories
 <b>2400M</b> 6-pt. Sockets 4, 4.5, 5, 5.5, 6, 7, 8, 9, 10, 11, 13	 <b>2753J</b>  <b>2760-50</b>  <b>2760-150</b>  <b>2768J</b>  <b>2770</b>  <b>2785</b>

**2251M / 2251A** Socket Set  
Steckschlüssel Satz  
Jeu de clés à douille

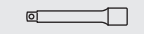

<b>2251A</b> 15 Pieces Set/△△=700g	
METAL CASE:W192×H122×T30mm	
Sockets	Accessories
 <b>2400A</b> 6-pt. Sockets 3/16, 7/32, 1/4, 9/32, 5/16, 11/32, 3/8, 7/16, 1/2	 <b>2753J</b>  <b>2760-50</b>  <b>2760-150</b>  <b>2768J</b>  <b>2770</b>  <b>2785</b>

**2258M** Socket Set  
Steckschlüssel Satz  
Jeu de clés à douille

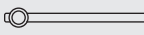
<b>2258M</b> 31 Pieces Set/△△=965g	
METAL CASE:W240×H100×T32mm	
Sockets	Accessories
 <b>2400M</b> 6-pt. Sockets 4, 4.5, 5, 5.5, 6, 7, 8, 9, 10, 11, 13  <b>2000.28</b> Bit Sockets 1, 2, 3  <b>2005.25</b> Bit Sockets 4, 6  <b>2010M.25</b> Bit Sockets 3, 4, 5, 6, 8  <b>2025.28</b> Bit Sockets T10, T15, T20, T25, T30	 <b>2753J</b>  <b>2760-100</b>  <b>2769N-150</b>  <b>2770</b>  <b>2785</b>

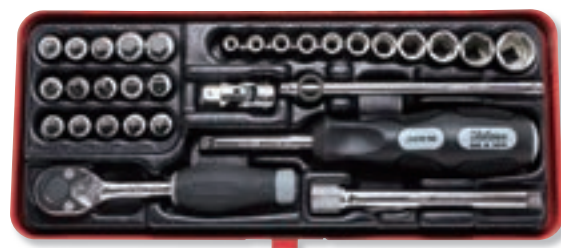

# Hand Sockets Hand Steckschlüssel Douilles à main

# 1/4"

Z-SERIES  
HAND  
TITANIUM  
SCREWDRIVERS ACCESSORIES  
IMPACT  
SLEEVE-DRIVE  
PROTECTOR  
INDUSTRIAL  
AUTOMOTIVE  
MOTORCYCLE  
CONSTRUCTION  
SPARE PART

**2259M** Socket Set  
Steckschlüssel Satz  
Jeu de clés à douille



2259M		31 Pieces Set/△=991g	
METAL CASE:W240xH100xT32mm			
Sockets		Accessories	
	<b>2400M</b> 6-pt. Sockets 4, 4.5, 5, 5.5, 6, 7, 8, 9, 10, 11, 13		<b>2774JS</b>
	<b>2000.28</b> Bit Sockets 1, 2, 3		<b>2760-100</b>
	<b>2005.25</b> Bit Sockets 4, 6		<b>2769N-150</b>
	<b>2010M.25</b> Bit Sockets 3, 4, 5, 6, 8		<b>2770</b>
	<b>2025.28</b> Bit Sockets T10, T15, T20, T25, T30		<b>2785</b>

**2263A** Socket Set  
Steckschlüssel Satz  
Jeu de clés à douille



2263A		29 Pieces Set/△=940g	
METAL CASE:W240xH100xT32mm			
Sockets		Accessories	
	<b>2400A</b> 6-pt. Sockets 1/8, 5/32, 3/16, 7/32, 1/4, 9/32, 5/16, 11/32, 3/8, 7/16, 1/2		<b>2753N</b>
	<b>2000.28</b> Bit Sockets 1, 2, 3		<b>2760-100</b>
	<b>2010A.25</b> Bit Sockets 1/8, 5/32, 3/16, 7/32, 1/4, 9/32, 5/16		<b>2769N-150</b>
	<b>2025.28</b> Bit Sockets T10, T15, T20, T25, T30		<b>2770</b>
			<b>2785</b>

**2275** Socket Set  
Steckschlüssel Satz  
Jeu de clés à douille



2275		19 Pieces Set/△=880g	
METAL CASE:W192xH122xT30mm			
Sockets		Accessories	
	<b>2400M</b> 6-pt. Sockets 5.5, 6, 7, 8, 10, 12, 13		<b>2753J</b>
	<b>2000.28</b> Bit Sockets 1, 2, 3		<b>2763-50</b>
	<b>2005.25</b> Bit Sockets 6, 8		<b>2769N-150</b>
	<b>2010M.25</b> Bit Sockets 3, 4, 5, 6		

**2276** Socket Set with Bits and Accessories  
Bit Satz mit Zubehör  
Jeu d'embouts et avec accessoires







2276		19 Pieces Set/△=640g	
METAL CASE:W192xH122xT30mm			
Bits		Accessories	
	<b>108P</b> Phillips Bits 1, 2, 3		<b>2753PS</b>
	<b>108S</b> Slotted Bits 4, 5, 6		<b>2769N-150</b>
	<b>108H</b> Hex Bits 3, 4, 5, 6		<b>2137</b>
	<b>108T</b> TORX® Bits T10, T15, T20, T25, T27, T30		

**2277** Socket Set  
Steckschlüssel Satz  
Jeu de clés à douille

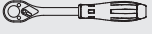
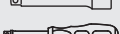



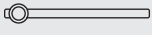

2277		21 Pieces Set/△=1,240g	
METAL CASE:W310xH86xT50mm			
Sockets		Accessories	
	<b>2400M</b> 6-pt. Sockets 5.5, 6, 7, 8, 9, 10, 11, 12, 13		<b>2753J</b>
	<b>2300M</b> 6-pt. Deep Sockets 5.5, 6, 7, 8, 9, 10, 11, 12, 13		<b>2763-75</b>
			<b>2769N-150</b>

P2201AM		25 Pieces Set/△△=800g	
PLASTIC CASE:W245xH120xT45mm			
Sockets	Accessories		
 <b>2400M</b> 6-pt. Sockets 4, 5, 5.5, 6, 7, 8, 9, 10, 11, 12, 13		<b>2753J</b>	
		<b>2760-100</b>	
 <b>2400A</b> 6-pt. Sockets 3/16, 7/32, 1/4, 9/32, 5/16, 11/32, 3/8, 7/16, 1/2		<b>2769N-150</b>	
		<b>2770</b>	
		<b>2785</b>	



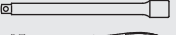

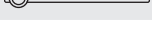



**P2201AM** Socket Set  
Steckschlüssel Satz  
Jeu de clés à douille

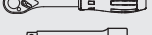

P2251M		18 Pieces Set/△△=770g	
PLASTIC CASE:W245xH120xT45mm			
Sockets	Accessories		
 <b>2400M</b> 6-pt. Sockets 4, 4.5, 5, 5.5, 6, 7, 8, 9, 10, 11, 12, 13		<b>2753J</b>	
		<b>2760-50</b>	
		<b>2760-150</b>	
		<b>2768J</b>	
		<b>2770</b>	
		<b>2785</b>	

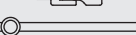
**P2251M** Socket Set  
Steckschlüssel Satz  
Jeu de clés à douille

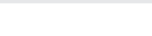

P2258M		31 Pieces Set/△△=860g	
PLASTIC CASE:W245xH120xT45mm			
Sockets	Accessories		
 <b>2400M</b> 6-pt. Sockets 4, 5, 5.5, 6, 7, 8, 9, 10, 11, 12, 13		<b>2753J</b>	
 <b>2000.28</b> Bit Sockets 1, 2, 3		<b>2760-100</b>	
 <b>2005.25</b> Bit Sockets 4, 6		<b>2769N-150</b>	
 <b>2010M.25</b> Bit Sockets 3, 4, 5, 6, 8		<b>2770</b>	
 <b>2025.28</b> Bit Sockets T10, T15, T20, T25, T30		<b>2785</b>	

**P2258M** Socket Set  
Steckschlüssel Satz  
Jeu de clés à douille



ABS Case - PE foam insert  
Kunststoffkassette - Weichschaumeinlage  
Coffret en ABS - Inserts en mousse

Z-SERIES  
HAND  
TITANIUM  
SCREWDRIVERS ACCESSORIES  
IMPACT  
SLEEVE-DRIVE  
PROTECTOR  
INDUSTRIAL  
AUTOMOTIVE  
MOTORCYCLE  
CONSTRUCTION  
SPARE PART

## 3400M / 3400A

6-point Sockets  
6-kant Steckschlüssel  
Douilles 6-pans

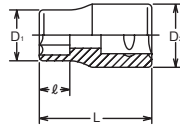

## 3405M / 3405A

12-point Sockets  
12-kant Steckschlüssel  
Douilles 12-pans

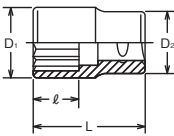

## FLAT DRIVE®

Flat drive is designed to guarantee a flat surface contact between the socket and the bolt/nut. The Flat contact reduces wear and allows to transmit a higher torque value. The Flat Drive System is also used for the square drive end as well as the hexagonal or bi-hexagonal openings of the socket.

Das Flat Drive Design sorgt für die optimale Kraftübertragung zwischen den Flächen des Steckschlüssels und der Schraube. Dies erlaubt eine Übertragung von höheren Drehmomenten. Das Flat Drive System findet ebenfalls bei allen Antriebsvierkanten sowie bei 6-kant und 12-kant Profilen Verwendung.

Le profil Flat Drive garantit un contact optimal entre la douille et l'écrou. Ce contact « à plat » réduit l'usure et permet la transmission d'un couple plus élevé. Ce système Flat Drive est utilisé pour tous les carrés conducteurs ainsi que pour toutes nos douilles 6-pans et 12-pans.

## RS3400M/12

Socket Set on Rail  
Steckschlüsselsatz auf Schiene  
Jeu de douilles sur rail



## RS3400A/9

Socket Set on Rail  
Steckschlüsselsatz auf Schiene  
Jeu de douilles sur rail



3400M 3405M (mm)	D <sub>1</sub> (mm)	D <sub>2</sub> (mm)	ℓ (mm)	L (mm)	(g)	(pcs.)
5	8.3	17.3	5	26	20	10
5.5	8.9	17.3	5.5	26	20	10
6	9.9	17.3	6	26	20	10
7	10.8	17.3	6.5	26	20	10
8	12	17.3	7	26	22	10
9	13.3	17.3	7.5	26	23	10
10	14.5	17.3	8	26	24	10
11	15.8	17.3	8.5	26	25	10
12	16.8	17.3	9	26	25	10
13	18	17	9.5	26	24	10
14	19.5	18.5	11	27	31	10
15	20.8	19.5	11.5	28	39	10
16	22	20	12	28	42	10
17	23.3	21.5	12.5	29	51	10
18	24.5	22.5	13	30	51	10
19	25.8	23.5	13.5	30	63	10
20	27	24.5	14	31	75	10
21	28	26	14.5	32	77	10
22	29.5	26.5	15	32	82	10
23	30.8	27.5	15.5	33	95	10
24	32	28.5	16	34	102	10
25	33.3	29.5	16.5	34	115	10
26	34.5	30.5	17	35	129	10

3400A 3405A (inch)	D <sub>1</sub> (mm)	D <sub>2</sub> (mm)	ℓ (mm)	L (mm)	(g)	(pcs.)
3/16	8.3	17.3	5	26	20	10
1/4	10.3	17.3	6	26	20	10
9/32	10.8	17.3	6.5	26	20	10
5/16	12	17.3	7	26	22	10
11/32	13.3	17.3	7.5	26	23	10
3/8	13.9	17.3	8	26	23	10
13/32	13.3	17.3	7.5	26	23	10
7/16	15.8	17.3	8.5	26	25	10
1/2	18	17	9.5	26	24	10
9/16	19.5	18.5	11	27	31	10
19/32	20.8	19.5	11.5	28	39	10
5/8	22	20	12	28	42	10
11/16	24.5	22.5	13	30	51	10
3/4	25.8	23.5	13.5	30	63	10
25/32	27	24.5	14	31	75	10
13/16	28	26	14.5	32	77	10
7/8	29.5	26.5	15	32	82	10
15/16	32	28.5	16	34	102	10
1	34.5	30.5	17	35	132	10

RS3400M/12	12 Pieces Set/Rail 300mm	(g)
8, 9, 10, 11, 12, 13, 14, 15, 16, 17, 18, 19		465

RS3405M/12	12 Pieces Set/Rail 300mm	(g)
8, 9, 10, 11, 12, 13, 14, 15, 16, 17, 18, 19		465

RS3400A/9	9 Pieces Set/Rail 200mm	(g)
1/4, 5/16, 3/8, 7/16, 1/2, 9/16, 5/8, 11/16, 3/4		333

RS3405A/9	9 Pieces Set/Rail 200mm	(g)
1/4, 5/16, 3/8, 7/16, 1/2, 9/16, 5/8, 11/16, 3/4		333

3410M (mm)	D <sub>1</sub> (mm)	D <sub>2</sub> (mm)	ℓ (mm)	L (mm)	(g)	(pcs.)
5.5	8.9	17.3	5.5	26	20	10
6	9.9	17.3	6	26	20	10
7	10.8	17.3	6.5	26	20	10
8	12	17.3	7	26	22	10
9	13.3	17.3	7.5	26	23	10
10	14.5	17.3	8	26	24	10
11	15.8	17.3	8.5	26	25	10
12	16.8	17.3	9	26	25	10
13	18	17	9.5	26	24	10
14	19.5	18.5	11	27	31	10
15	20.8	19.5	11.5	28	39	10
16	22	20	12	28	42	10
17	23.3	21.5	12.5	29	51	10
18	24.5	22.5	13	30	51	10
19	25.8	23.5	13.5	30	63	10
20	27	24.5	14	31	75	10
21	28	26	14.5	32	77	10
22	29.5	26.5	15	32	82	10
23	30.8	27.5	15.5	33	95	10
24	32	28.5	16	34	102	10

RS3410M/12	12 Pieces Set/Rail 300mm	(g)
8, 9, 10, 11, 12, 13, 14, 15, 16, 17, 18, 19		468

3400W 3405W (W)	D <sub>1</sub> (mm)	D <sub>2</sub> (mm)	ℓ (mm)	L (mm)	(g)	(pcs.)
1/8	13.3	17.3	7.5	26	22	10
3/16	15.8	17.3	8.5	26	25	10
1/4	18	17	9.5	26	24	10
5/16	20.8	19.5	11.5	28	39	10
3/8	24.5	22.5	13	30	51	10
7/16	28	26	14.5	32	81	10
1/2	30.8	27.5	15.5	33	103	10
9/16	34.5	30.5	17	35	128	10

BS W	S	BS · W													
		BS	3/16BS	1/4BS	5/16BS	3/8BS	7/16BS	1/2BS	9/16BS	5/8BS	11/16BS	3/4BS	7/8BS		
		W	1/8W	3/16W	1/4W	5/16W	3/8W	7/16W	1/2W	9/16W	5/8W	11/16W	3/4W		
Across Flat	(ref. mm)	8.6	11.3	13.3	15.2	18.0	20.8	23.4	25.7	27.9	30.5	33.0			

RS3400W/7	7 Pieces Set/Rail 200mm	(g)
1/8, 3/16, 1/4, 5/16, 3/8, 7/16, 1/2		389

RS3405W/7	7 Pieces Set/Rail 200mm	(g)
1/8, 3/16, 1/4, 5/16, 3/8, 7/16, 1/2		389

## 3410M

Surface Drive Sockets  
Surface Drive Steckschlüssel  
Douilles, Surface Drive

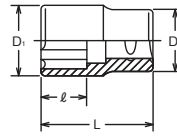

## SURFACE DRIVE

Surface drive sockets are designed to retain contact with the flat sides of the nut in order to transmit higher torque and reduce nut wear. These sockets are ideal for using on polished nuts, aluminum nuts and nuts with worn out points.

Das Profil unserer Surface-Drive Steckschlüssel greift die Schraube an deren Flächen. Dies sichert eine höhere Kraftübertragung und verhindert ein Durchrutschen des Steckschlüssels. Diese Steckschlüssel eignen sich besonders für polierte Schrauben, Aluminium Schrauben und Schrauben bei denen die Ecken bereits abgerundet sind.

Notre profil Surface Drive assure le contact entre la douille et les plats de l'écrou. Ceci réduit l'usure et permet la transmission d'un couple plus élevé. C'est une solution idéale pour les écrous polis, celles en aluminium ou arrondies.

## RS3410M/12

Socket Set on Rail  
Steckschlüsselsatz auf Schiene  
Jeu de douilles sur rail



## 3400W

6-point Whitworth Sockets  
6-kant Steckschlüssel, Whitworth  
Douilles à 6-pans Whitworth

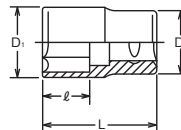

## 3405W

12-point Whitworth Sockets  
12-kant Steckschlüssel, Whitworth  
Douilles à 12-pans Whitworth

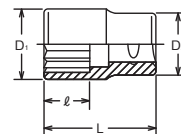

## RS3400W/7

Socket Set on Rail  
Steckschlüsselsatz auf Schiene  
Jeu de douilles sur rail

## RS3405W/7



Z-SERIES  
HAND  
TITANIUM  
SCREWDRIVERS ACCESSORIES  
IMPACT  
SLEEVE-DRIVE  
PROTECTOR  
INDUSTRIAL  
AUTOMOTIVE  
MOTORCYCLE  
CONSTRUCTION  
SPARE PART

## 3415M / 3415A

Double 4-point Sockets  
Doppelvierkant Steckschlüssel  
Douilles 4-pans, doubles

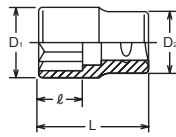

	3415M (mm)	D <sub>1</sub> (mm)	D <sub>2</sub> (mm)	ℓ (mm)	L (mm)	(g)	(pcs.)
New	5.5	10.8	17.4	5.5	26	21	10
	6	12	17.3	6	26	26	10
New	7	13.3	17.4	6.5	26	26	10
	8	14.5	17.3	7	26	26	10
	10	16.8	17.3	8	26	27	10
	12	20.8	19.5	9	27	43	10
New	13	21.9	20	9.5	27	46	10

	3415A (inch)	D <sub>1</sub> (mm)	D <sub>2</sub> (mm)	ℓ (mm)	L (mm)	(g)	(pcs.)
	1/4	12	17.3	6	26	24	10
	5/16	14.5	17.3	7	26	26	10
	11/32	15.8	17.3	7.5	26	27	10
	3/8	16.8	17.3	8	26	27	10
	7/16	19.5	18.5	8.5	27	37	10
	1/2	22	20	9.5	27	46	10

## 3425

TORX® Sockets  
TORX® Steckschlüssel  
Douilles TORX®

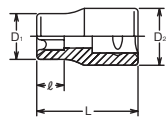

	3425 (E)	D <sub>1</sub> (mm)	D <sub>2</sub> (mm)	ℓ (mm)	L (mm)	(g)	(pcs.)
	E 4	5.6	17.3	4.6	26	18	10
	E 5	7	17.3	5.2	26	20	10
	E 6	8.3	17.3	5.4	26	21	10
	E 7	8.9	17.3	6.6	26	22	10
	E 8	9.9	17.3	7	26	23	10
	E10	12	17.3	8.2	26	24	10
	E11	13.3	17.3	8.7	26	25	10
	E12	14.5	17.3	9.3	26	26	10
	E14	15.8	17.3	10.6	26	27	10
	E16	18	17	11.8	26	27	10

### TORX® (E)

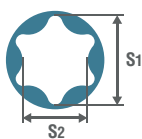

	E	E4	E5	E6	E7	E8	E10	E11	E12	E14	E16	E18	E20	E22	E24	E26	E28
S <sub>1</sub>	(ref. mm)	3.7	4.6	5.6	6.1	7.4	9.3	9.9	11.0	12.8	14.6	16.5	18.3	20.1	22.0	23.7	25.5
S <sub>2</sub>	(ref. mm)	2.7	3.3	4.0	4.3	5.3	6.8	7.1	7.9	9.2	10.5	11.9	13.2	14.8	15.7	17.5	18.3

## RS3425/9

Socket Set on Rail  
Steckschlüsselsatz auf Schiene  
Jeu de douilles sur rail



RS3425/9	9 Pieces Set/Rail 200mm	(g)
E4, E5, E6, E7, E8, E10, E12, E14, E16		239

## RSX425/14

Socket Set on Rail  
Steckschlüsselsatz auf Schiene  
Jeu de douilles sur rail



RSX425/14	14 Pieces Set/Rail 300mm	(g)
2425	1/4"	E4, E5, E6, E7, E8
3425	3/8"	E10, E11, E12, E14
4425	1/2"	E16, E18, E20, E22, E24
		550

## 3400LH

LHSTIX® Sockets  
Steckschlüssel mit LHSTIX® Profil  
Douilles au profil LHSTIX®

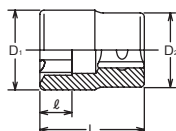

3400LH (LH-S)	D <sub>1</sub> (mm)	D <sub>2</sub> (mm)	ℓ (mm)	L (mm)	(g)	(pcs.)
5S	10.8	17.3	5	26	20	10
6S	12	17.3	5.6	26	22	10
8S	15.8	17.3	6.8	26	25	10
10S	18	17	8	26	25	10
12S	22	20	9.2	28	42	10
14S	24.5	22.5	10.4	30	51	10
16S	28	26	11.6	32	77	10

TORX is a registered trademark of Acument Intellectual Properties, LLC.  
TORX ist ein registriertes Markenzeichen der Firma Acument Intellectual Properties, LLC.  
TORX est une marque déposée de Acument Intellectual Properties, LLC.

LHSTIX is a registered trademark of OSG CORPORATION System Engineering Department.  
LHSTIX ist ein registriertes Markenzeichen der Firma OSG CORPORATION System Engineering Department.  
LHSTIX est une marque déposée de OSG CORPORATION System Engineering Department.

# 3/8"

Hand Sockets  
Hand Steckschlüssel  
Douilles à main

RS3400LH/7	7 Pieces Set/Rail 150mm	 (g)
5S, 6S, 8S, 10S, 12S, 14S, 16S		315



**RS3400LH/7**   Socket Set on Rail  
Steckschlüsselsatz auf Schiene  
Jeu de douilles sur rail

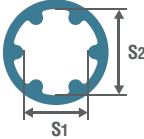

**LHSTIX®**



LH-S	LH-5S	LH-6S	LH-8S	LH-10S	LH-12S	LH-14S	LH-16S
S <sub>1</sub> (ref. mm)	5.6	6.8	9.0	11.3	13.6	15.8	18.1
S <sub>2</sub> (ref. mm)	7.5	9.0	12.0	15.0	18.0	21.0	24.0

3450M (mm)	D <sub>1</sub> (mm)	D <sub>2</sub> (mm)	ℓ (mm)	L (mm)	 (g)	 (pcs.)
8	12	17.3	5	26	21	10
10	14.5	17.3	6	26	24	10
11	15.8	17.3	6.5	26	26	10
12	16.8	17.3	7	26	26	10
13	18	17	8	26	28	10
14	19.5	18.5	8.5	27	34	10
15	20.8	19.5	9	27	42	10
16	22	20	9	27	50	10
17	23.3	21.5	9.5	28	62	10
18	24.5	22.5	10.5	29	64	10
19	25.8	23.3	11.5	29	66	10
21	28	26	12	29	85	10
22	29.5	27	12.5	29	90	10
24	32	30	14.5	31	102	10

**3450M**  Nut Grip Sockets **Nut Grip®**  
Steckschlüssel mit 2-facher Kugelhalterung  
Douilles à billes de retenue

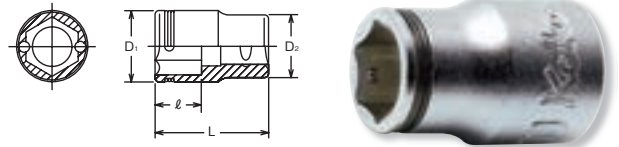

**NUT GRIP®**

Twin balls at the 6-point opening hold bolt/nut tightly for safe and reliable work.

Die zwei Kugeln in der 6-kant Öffnung unserer NUT GRIP Steckschlüssel halten die Schraube sicher im Steckschlüssel. Dies erlaubt ein Arbeiten auch an schwer zugänglichen Stellen.



Les 2 billes dans l'ouverture du 6-pans de la douille retiennent l'écrou de manière sûre et efficace.

RS3450M/8	8 Pieces Set/Rail 200mm	 (g)
8, 10, 11, 12, 13, 14, 17, 19		310





**RS3450M/8**   Socket Set on Rail  
Steckschlüsselsatz auf Schiene  
Jeu de douilles sur rail

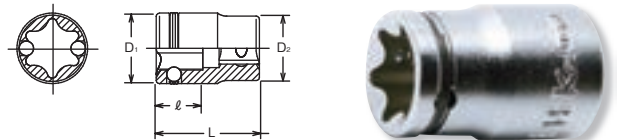

3425 (2B)	D <sub>1</sub> (mm)	D <sub>2</sub> (mm)	ℓ (mm)	L (mm)	 (g)	 (pcs.)
E10	12	17.3	8.2	26	23	10
E12	14.5	17.3	9.3	26	25	10
E14	15.8	17.3	10.6	26	26	10
E16	18.1	17	11.8	26	27	10
E18	19.5	18.5	12	32	41	10
E20	21.9	20	14.4	32	52	10

**3425 (2B)**  TORX® Sockets **Nut Grip®**  
TORX Steckschlüssel mit 2-facher Kugelhalterung  
Douilles Torx à deux billes de retenue



RS3425/4(2B)	4 Pieces Set/Rail 150mm	 (g)
E10, E12, E14, E20		150

**RS3425/4 (2B)**   Socket Set on Rail  
Steckschlüsselsatz auf Schiene  
Jeu de douilles sur rail



**TORX** is a registered trademark of Acument Intellectual Properties, LLC.  
**TORX** ist ein registriertes Markenzeichen der Firma Acument Intellectual Properties, LLC.  
**TORX** est une marque déposée de Acument Intellectual Properties, LLC.

**LHSTIX** is a registered trademark of OSG CORPORATION System Engineering Department.  
**LHSTIX** ist ein registriertes Markenzeichen der Firma OSG CORPORATION System Engineering Department.  
**LHSTIX** est une marque déposée de OSG CORPORATION System Engineering Department.

Z-SERIES  
HAND  
TITANIUM  
ACCESSORIES  
SCREWDRIVERS  
IMPACT  
SLEEVE-DRIVE  
PROTECTOR  
INDUSTRIAL  
AUTOMOTIVE  
MOTORCYCLE  
CONSTRUCTION  
SPARE PART

Z-SERIES  
HAND  
TITANIUM  
SCREWDRIVERS ACCESSORIES  
IMPACT  
SLEEVE-DRIVE  
PROTECTOR  
INDUSTRIAL  
AUTOMOTIVE  
MOTORCYCLE  
CONSTRUCTION  
SPARE PART

## 3300X / 3300XA

6-point Sockets, Semi-Deep  
6-kant Steckschlüssel, mittel-lang  
Douilles, semi-profondes 6-pans



3300X 3305X (mm)	D <sub>1</sub> (mm)	D <sub>2</sub> (mm)	ℓ (mm)	H (mm)	L (mm)	(g)	(pcs.)
8	12	17.3	9	26.5	40	34	10
9	13	17.3	10	26.5	40	36	10
10	14.5	17.3	11	26.5	40	36	10
11	16	17.2	12	26.5	40	36	10
12	16.8	17.2	13	26.5	40	36	10
13	18	17	14	26.5	40	37	10
14	20	18	16	26.5	40	46	10
15	21	20	16	25.5	40	49	10
16	22	20	17	25.5	40	51	10
17	23.5	22	18	25.5	40	61	10
18	24.5	23	19	24.5	40	68	10
19	25	24	20	24.5	40	75	10

## 3305X / 3305XA

12-point Sockets, Semi-Deep  
12-kant Steckschlüssel, mittel-lang  
Douilles, semi-profondes 12-pans



3300XA 3305XA (inch)	D <sub>1</sub> (mm)	D <sub>2</sub> (mm)	ℓ (mm)	H (mm)	L (mm)	(g)	(pcs.)
1/4	10.3	17.3	7	26.5	40	32	10
5/16	12	17.3	9	26.5	40	34	10
3/8	13.9	17.3	11	26.5	40	36	10
7/16	16	17.2	12	26.5	40	36	10
1/2	18	17	14	26.5	40	37	10
9/16	20	18.5	16	26.5	40	46	10
5/8	22	20	17	25.5	40	51	10
11/16	24.5	22.5	19	24.5	40	68	10
3/4	25	23.5	20	24.5	40	75	10

## RS3300X/8 RS3305X/8

Socket Set on Rail  
Steckschlüsselsatz auf Schiene  
Jeu de douilles sur rail



RS3300X/8	8 Pieces Set/Rail 200mm	(g)
8, 10, 11, 12, 13, 14, 17, 19		405

RS3305X/8	8 Pieces Set/Rail 200mm	(g)
8, 10, 11, 12, 13, 14, 17, 19		405

## RS3300XA/9 RS3305XA/9

Socket Set on Rail  
Steckschlüsselsatz auf Schiene  
Jeu de douilles sur rail



RS3300XA/9	9 Pieces Set/Rail 200mm	(g)
1/4, 5/16, 3/8, 7/16, 1/2, 9/16, 5/8, 11/16, 3/4		460

RS3305XA/9	9 Pieces Set/Rail 200mm	(g)
1/4, 5/16, 3/8, 7/16, 1/2, 9/16, 5/8, 11/16, 3/4		460

## 3350X

Nut Grip Socket, Semi-Deep **Nut Grip®**  
Steckschlüssel mit 2-facher Kugelhalterung, mittel-lang  
Douilles à billes de retenue, semi-profondes



3350X (mm)	D <sub>1</sub> (mm)	D <sub>2</sub> (mm)	ℓ (mm)	H (mm)	L (mm)	(g)	(pcs.)
8	12	17.4	5	26.5	40	33	10
10	14.5	17.4	6	26.5	40	35	10
12	16.8	17.2	7	26.5	40	40	10
14	19.5	18.5	8.5	26.5	40	48	10

## RS3350X/4

Socket Set on Rail  
Steckschlüsselsatz auf Schiene  
Jeu de douilles sur rail



RS3350X/4	4 Pieces Set/Rail 150mm	(g)
8, 10, 12, 14		165



3300M 3305M (mm)	D <sub>1</sub> (mm)	D <sub>2</sub> (mm)	ℓ (mm)	H (mm)	L (mm)	(g)	(pcs.)
5.5	8.9	17.3	6.5	41.5	55	37	10
6	9.9	17.3	7	41.5	55	37	10
7	10.6	17.3	8	41.5	55	37	10
8	12	17.3	9	41.5	55	40	10
9	13	17.3	10	41.5	55	42	10
10	14.5	17.3	11	41.5	55	46	10
11	16	17.2	12	41.5	55	51	10
12	16.8	17.2	13	41.5	55	52	10
13	18	17	14	41.5	55	53	10
14	20	18	16	41.5	55	60	10
15	21	20	16	40.5	55	74	10
16	22	20	17	40.5	55	76	10
17	23.5	22	18	40.5	55	93	10
18	24.5	23	19	39.5	55	98	10
19	25	24	20	39.5	55	98	10
20	26	25	21	49.5	65	126	10
21	27	26	22	49.5	65	126	10
22	29	28	23	48.5	65	163	10
23	30	29	24	48.5	65	168	10
24	31	30	25	47.5	65	191	10
25	33	30	26	47.5	65	199	10
26	34	31	27	47.5	65	209	10
27	35	32.5	28	47.5	65	218	10

3300A 3305A (inch)	D <sub>1</sub> (mm)	D <sub>2</sub> (mm)	ℓ (mm)	H (mm)	L (mm)	(g)	(pcs.)
7/32	8.9	17.3	6	41.5	55	35	10
1/4	9.9	17.3	7	41.5	55	37	10
5/16	12	17.3	9	41.5	55	40	10
11/32	12.3	17.3	10	41.5	55	41	10
3/8	14	17.3	11	41.5	55	46	10
7/16	16	17.2	12	41.5	55	51	10
1/2	18	17	14	41.5	55	53	10
9/16	20	18	16	41.5	55	60	10
19/32	21	20	16	40.5	55	74	10
5/8	22	20	17	40.5	55	76	10
11/16	23.5	22	18	40.5	55	93	10
3/4	25	24	20	39.5	55	98	10
13/16	27	26	22	49.5	65	126	10
7/8	29	28	23	48.5	65	163	10
15/16	31	30	25	47.5	65	191	10

RS3300M/12	12 Pieces Set/Rail 300mm	(g)
8, 9, 10, 11, 12, 13, 14, 15, 16, 17, 18, 19		878

RS3305M/12	12 Pieces Set/Rail 300mm	(g)
8, 9, 10, 11, 12, 13, 14, 15, 16, 17, 18, 19		878

RS3300A/9	9 Pieces Set/Rail 200mm	(g)
1/4, 5/16, 3/8, 7/16, 1/2, 9/16, 5/8, 11/16, 3/4		628

RS3305A/9	9 Pieces Set/Rail 200mm	(g)
1/4, 5/16, 3/8, 7/16, 1/2, 9/16, 5/8, 11/16, 3/4		628

## 3300M / 3300A

6-point Deep Sockets  
6-kant-Steckschlüssel,lang  
Douilles longues 6-pans

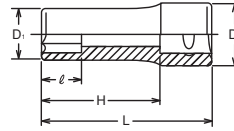

## 3305M / 3305A

12-point Deep Sockets  
12-kant Steckschlüssel,lang  
Douilles longues, 12-pans

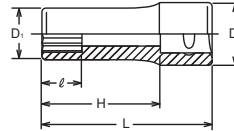

## RS3300M/12



Socket Set on Rail  
Steckschlüsselsatz auf Schiene  
Jeu de douilles sur rail

## RS3305M/12



## RS3300A/9



Socket Set on Rail  
Steckschlüsselsatz auf Schiene  
Jeu de douilles sur rail

## RS3305A/9



Z-SERIES  
HAND  
TITANIUM  
ACCESSORIES  
SCREWDRIVERS  
IMPACT  
SLEEVE-DRIVE  
PROTECTOR  
INDUSTRIAL  
AUTOMOTIVE  
MOTORCYCLE  
CONSTRUCTION  
SPARE PART

### 3300M (L120)

6-point Extra Deep Sockets  
6-kant Steckschlüssel, extra lang  
Douilles extra longues 6-pans



### 3305M (L120)

12-point Extra Deep Sockets  
12-kant Steckschlüssel, extra lang  
Douilles extra longues 12-pans

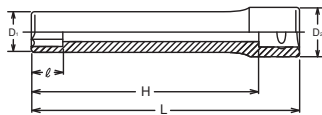

### 3300M/4-L120 3305M/4-L120

Socket Set  
Steckschlüssel Satz  
Jeu de clés à douille



### 3310M

Surface Drive Deep Sockets  
Surface Drive Steckschlüssel, lang  
Douilles longues, Surface Drive

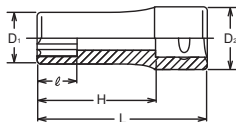

### RS3310M/12

Socket Set on Rail  
Steckschlüsselsatz auf Schiene  
Jeu de douilles sur rail



3300M(L120) 3305M(L120) (mm)	D <sub>1</sub> (mm)	D <sub>2</sub> (mm)	ℓ (mm)	H (mm)	L (mm)	(g)	(pcs.)
8	12	17.3	9	106.5	120	85	10
10	14.5	17.3	11	106.5	120	110	10
12	16.8	17.2	13	106.5	120	116	10
13	18	17	14	106.5	120	155	5
14	20	18	16	106.5	120	166	5

3300M-Size DEEP SOCKET

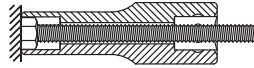

3300M-Size (L120) EXTRA DEEP SOCKET

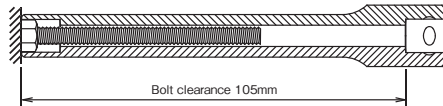

3300M/4-L120	4 Pieces Set/△=477g
PLASTIC BAG	
Sockets	
3300M(L120) 6-point Extra Deep Sockets 8, 10, 12, 14	

3305M/4-L120	4 Pieces Set/△=477g
PLASTIC BAG	
Sockets	
3305M(L120) 12-point Extra Deep Sockets 8, 10, 12, 14	

3310M (mm)	D <sub>1</sub> (mm)	D <sub>2</sub> (mm)	ℓ (mm)	H (mm)	L (mm)	(g)	(pcs.)
6	9.9	17.3	7	41.5	55	37	10
7	10.6	17.3	8	41.5	55	37	10
8	12	17.3	9	41.5	55	40	10
9	13	17.3	10	41.5	55	42	10
10	14.5	17.3	11	41.5	55	46	10
11	16	17.2	12	41.5	55	51	10
12	16.8	17.2	13	41.5	55	52	10
13	18	17	14	41.5	55	53	10
14	20	18	16	41.5	55	60	10
15	21	20	16	40.5	55	74	10
16	22	20	17	40.5	55	76	10
17	23.5	22	18	40.5	55	93	10
18	24.5	23	19	39.5	55	98	10
19	25	24	20	39.5	55	98	10
20	26	25	21	49.5	65	126	10
21	27	26	22	49.5	65	126	10
22	29	28	23	48.5	65	163	10
23	30	29	24	48.5	65	168	10
24	31	30	25	47.5	65	161	10

RS3310M/12	12 Pieces Set/Rail 300mm	(g)
8, 9, 10, 11, 12, 13, 14, 15, 16, 17, 18, 19		881

3300W 3305W (W)	D <sub>1</sub> (mm)	D <sub>2</sub> (mm)	ℓ (mm)	H (mm)	L (mm)	(g)	(pcs.)
1/8	12.3	17.3	10	41.5	55	46	10
3/16	16	17.3	12	41.5	55	55	10
1/4	18	17	14	41.5	55	57	10
5/16	21	20	16	40.5	55	79	10
3/8	24.5	23	19	39.5	55	96	10
7/16	27	26	22	49.5	65	140	10
1/2	30	29	24	48.5	65	193	10
9/16	34	31	27	47.5	65	250	10

**3300W**  6-point Deep Whitworth Sockets  
6-kant Steckschlüssel, lang, Whitworth  
Douilles longues à 6-pans Whitworth

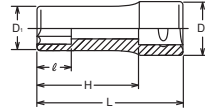

**3305W**  12-point Deep Whitworth Sockets  
12-kant Steckschlüssel, Whitworth  
Douilles longues à 12-pans Whitworth

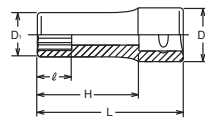

### BS W



BS · W	BS	3/16BS	1/4BS	5/16BS	3/8BS	7/16BS	1/2BS	9/16BS	5/8BS	11/16BS	3/4BS	7/8BS
	W	1/8W	3/16W	1/4W	5/16W	3/8W	7/16W	1/2W	9/16W	5/8W	11/16W	3/4W
Across Flat	(ref. mm)	8.6	11.3	13.3	15.2	18.0	20.8	23.4	25.7	27.9	30.5	33.0

RS3300W/7	7 Pieces Set/Rail 200mm	(g)
1/8, 3/16, 1/4, 5/16, 3/8, 7/16, 1/2		719

RS3305W/7	7 Pieces Set/Rail 200mm	(g)
1/8, 3/16, 1/4, 5/16, 3/8, 7/16, 1/2		719

**RS3300W/7**   Socket Set on Rail  
Steckschlüsselsatz auf Schiene  
Jeu de douilles sur rail

**RS3305W/7**   Socket Set on Rail  
Steckschlüsselsatz auf Schiene  
Jeu de douilles sur rail



3325 (E)	D <sub>1</sub> (mm)	D <sub>2</sub> (mm)	ℓ (mm)	H (mm)	L (mm)	(g)	(pcs.)
E 4	5.6	17.3	4.6	41.5	55	29	10
E 5	6.9	17.3	5.2	41.5	55	31	10
E 6	7.9	17.3	5.4	41.5	55	33	10
E 7	8.9	17.3	6.6	41.5	55	36	10
E 8	9.9	17.3	7	41.5	55	39	10
E10	11.8	17.3	8.2	41.5	55	43	10
E12	14.5	17.2	9.3	41.5	55	53	10
E14	15.7	17.2	10.6	41.5	55	57	10
E16	18	17	11.8	41.5	55	69	10

**3325**  TORX® Deep Sockets  
TORX® Steckschlüssel, lang  
Douilles longues TORX®

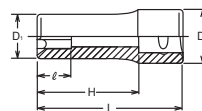

RS3325/9	9 Pieces Set/Rail 200mm	(g)
E4, E5, E6, E7, E8, E10, E12, E14, E16		420

**RS3325/9**   Socket Set on Rail  
Steckschlüsselsatz auf Schiene  
Jeu de douilles sur rail



Z-SERIES  
HAND  
TITANIUM  
SCREWDRIVERS  
ACCESSORIES  
IMPACT  
SLEEVE-DRIVE  
PROTECTOR  
INDUSTRIAL  
AUTOMOTIVE  
MOTORCYCLE  
CONSTRUCTION  
SPARE PART

### 3350M

 Nut Grip Deep Sockets **Nut Grip®**  
Steckschlüssel mit 2-facher Kugelhalterung, lang  
Douilles longues à billes de retenue



3350M (mm)	D <sub>1</sub> (mm)	D <sub>2</sub> (mm)	ℓ (mm)	H (mm)	L (mm)	(g)	(pcs.)
8	12	17.4	5	41.5	55	50	10
10	14.5	17.4	6	41.5	55	54	10
12	16.8	17.2	7	41.5	55	58	10
13	18	17	8	41.5	55	59	10
14	19.5	18.5	8.5	41.5	55	71	10

### RS3350M/5

 Socket Set on Rail  
Steckschlüsselsatz auf Schiene  
Jeu de douilles sur rail



RS3350M/5	5 Pieces set/Rail 150mm	(g)
8, 10, 12, 13, 14		322

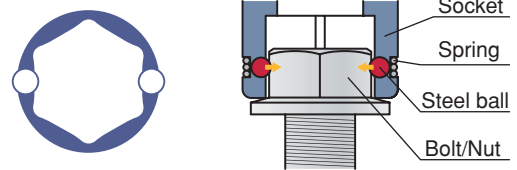

### 3350M (L120)

 Nut Grip Deep Sockets **Nut Grip®**  
Steckschlüssel mit 2-facher Kugelhalterung, lang  
Douilles à billes de retenue



3350M(L120) (mm)	D <sub>1</sub> (mm)	D <sub>2</sub> (mm)	ℓ (mm)	H (mm)	L (mm)	(g)	(pcs.)
10	14.5	17.2	6	106.5	120	110	10
12	16.8	17.2	7	106.5	120	116	10

### 3350M/2-L120

 Socket Set  
Geschlitzte Steckschlüssel Satz  
Jeu de clés à douille

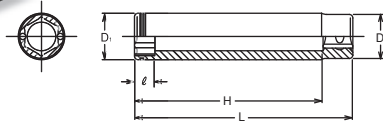
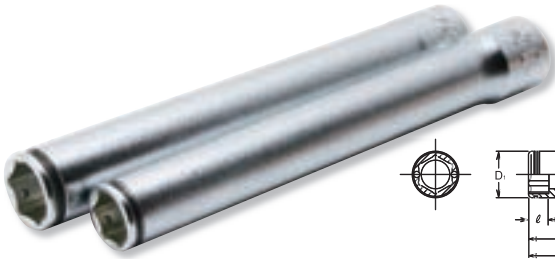

3350M/2-L120	2 Pieces Set/△=230g
PLASTIC BAG	
Sockets	
 3350M(L120) Nut Grip Extra Deep Sockets	10, 12

### 3300FN

 Flare Nut Sockets  
Geschlitzte Steckschlüssel für Überwurfmuttern  
Douilles à tuyauter

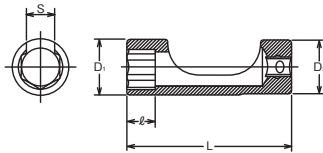

3300FN (mm)	D <sub>1</sub> (mm)	D <sub>2</sub> (mm)	ℓ (mm)	L (mm)	S (mm)	(g)	(pcs.)
8	14.5	17.3	6	53	6.4	38	10
9	16	17.3	7	53	6.8	41	10
10	16.8	17.2	7.5	53	7.2	42	10
11	18	17	8.5	53	8.3	42	10
12	20	18	9	53	8.8	50	10
13	21.1	20	9.5	62	9.4	66	10
14	22	20	10.5	62	10.5	66	10
15	23	22	11	70	11.5	82	10
16	24	23	11.5	70	12	90	10
17	25	24	12.5	80	13	110	10
18	27	25	13	80	13.5	120	10
19	28	26	14	80	14.5	130	10
22	32	29.5	16	80	16	180	10
24	34.5	31.5	17	80	17	200	10

### RS3300FN/8

 Socket Set on Rail  
Steckschlüsselsatz auf Schiene  
Jeu de douilles sur rail



RS3300FN/8	8 Pieces Set/Rail 200mm	(g)
9, 10, 11, 13, 14, 16, 17, 19		600

3440M 3445M (mm)	D <sub>1</sub> (mm)	D <sub>2</sub> (mm)	ℓ (mm)	L (mm)	(g)	(pcs.)
8	12	19	7.3	47	50	10
9	13.3	19	7.8	47.5	50	10
10	14.5	19	8.8	48.5	64	10
11	15.8	19	9.8	49.5	66	10
12	17	19	10.3	50	67	10
13	18.3	19	11.3	51	68	10
14	19.5	19	11.3	51	69	10
15	20.8	19	12.8	53.5	70	10
16	22	19	12.8	53.5	77	10
17	23.3	19	13.8	54.5	80	10
18	24.5	19	13.8	54.5	80	10
19	25.8	19	15.8	56.5	84	10
21	28.3	19	16.8	56.5	96	10

## 3440M / 3440A

6-point Universal Sockets  
6-kant Gelenk-Einsätze  
Douilles articulées, 6-pans

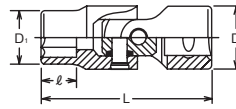

3440A 3445A (inch)	D <sub>1</sub> (mm)	D <sub>2</sub> (mm)	ℓ (mm)	L (mm)	(g)	(pcs.)
5/16	12	19	7.3	47	50	10
3/8	14	19	8.3	48	64	10
7/16	15.8	19	9.8	49.5	66	10
1/2	18.3	19	11.3	51	68	10
9/16	19.5	19	11.3	51	69	10
5/8	22	19	12.8	53.5	77	10
11/16	24.5	19	13.8	54.5	80	10
3/4	25.8	19	15.8	56.5	84	10

## 3445M / 3445A

12-point Universal Sockets  
12-kant Gelenk-Einsätze  
Douilles articulées, 12-pans

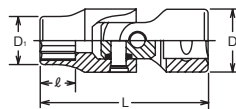

RS3440M/8	8 Pieces Set/Rail 200mm	(g)
8, 10, 11, 12, 13, 14, 17, 19		550

RS3440A/8	8 Pieces Set/Rail 200mm	(g)
5/16, 3/8, 7/16, 1/2, 9/16, 5/8, 11/16, 3/4		570

## RS3440M/8 RS3440A/8

Socket Set on Rail  
Steckschlüsselsatz auf Schiene  
Jeu de douilles sur rail

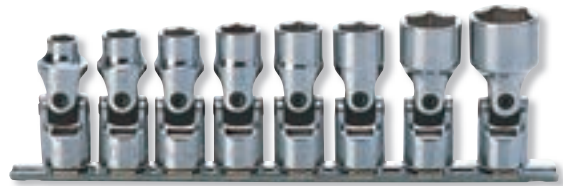

3445W (W)	D <sub>1</sub> (mm)	D <sub>2</sub> (mm)	ℓ (mm)	L (mm)	(g)	(pcs.)
1/8	13.3	19	7.8	47.5	50	10
3/16	15.8	19	9.7	49.5	66	10
1/4	18.3	19	11.3	51	68	10
5/16	20.8	19	12.8	53.5	70	10
3/8	24.5	19	13.8	54.5	80	10
7/16	28.3	19	16.8	57.5	96	10
1/2	30.8	19	17.8	58.5	105	10

## 3445W

12-Point Whitworth Universal Socket  
12-kant Gelenk-Einsatz, Whitworth  
Douille articulées, 12-pans, Whitworth

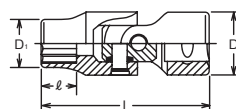

RS3445W/7	7 Pieces Set/Rail 200mm	(g)
1/8, 3/16, 1/4, 5/16, 3/8, 7/16, 1/2		570

## RS3445W/7

Socket Set on Rail  
Steckschlüsselsatz auf Schiene  
Jeu de douilles sur rail



Z-SERIES  
HAND  
TITANIUM  
SCREWDRIVERS  
ACCESSORIES  
IMPACT  
SLEEVE-DRIVE  
PROTECTOR  
INDUSTRIAL  
AUTOMOTIVE  
MOTORCYCLE  
CONSTRUCTION  
SPARE PART

### 3440T

TORX® Universal Sockets  
TORX® Gelenk-Einsätze  
Douilles articulées TORX®

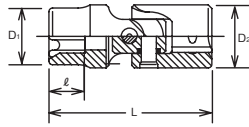

3440T (E)	D <sub>1</sub> (mm)	D <sub>2</sub> (mm)	ℓ (mm)	L (mm)	(g)	(pcs.)
E 6	7.9	19	5.4	44.9	60	10
E 8	9.9	19	7	46.5	63	10
E10	11.8	19	8.2	47.7	63	10
E12	14.5	19	9.3	48.8	68	10
E14	15.7	19	10.6	50.1	68	10
E16	18	19	11.8	51.3	70	10
E18	19.5	19	13	53.5	78	10
E20	22	19	14.4	54.9	81	10

### RS3440T/8

Socket Set on Rail  
Steckschlüsselsatz auf Schiene  
Jeu de douilles sur rail



RS3440T/8	8 Pieces Set/Rail 200mm	(g)
E6, E8, E10, E12, E14, E16, E18, E20		594

### 3441M

Nut Grip Universal Sockets **Nut Grip®**  
Gelenk-Einsätze mit zweifacher Kugelhalterung  
Douilles articulées, à billes de retenue

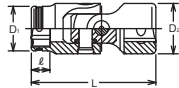

3441M (mm)	D <sub>1</sub> (mm)	D <sub>2</sub> (mm)	ℓ (mm)	L (mm)	(g)	(pcs.)
8	12	19	5	46	57	10
10	14.5	19	6	46	58	10
12	16.8	19	7	47	58	10
13	18	19	8	48	60	10
14	19.5	19	8.5	49.5	65	10



### RS3441M/5

Socket Set on Rail  
Steckschlüsselsatz auf Schiene  
Jeu de douilles sur rail



RS3441M/5	5 Pieces Set/Rail 150mm	(g)
8, 10, 12, 13, 14		320

### 3340M-75

Universal Deep Sockets  
Gelenk-Steckschlüssel, lange Ausführung  
Douilles articulées longues

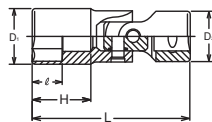

3340M-75 (mm)	D <sub>1</sub> (mm)	D <sub>2</sub> (mm)	ℓ (mm)	H (mm)	L (mm)	(g)	(pcs.)
8	12	19	9	39	75	82	10
10	14.5	19	11	39	75	87	10
11	15.8	19	12	39	75	87	10
12	17	19	13	39	75	92	10
13	18.3	19	14	36	75	93	10
14	19.5	19	15	35	75	103	10
15	20.8	19	16	35	75	104	10
16	22	19	17	34	75	110	10
17	23.3	19	18	34	75	115	10
18	24.5	19	19	34	75	119	10
19	25.8	19	20	33	75	123	10

### RS3340M/8-L75

Socket Set on Rail  
Steckschlüsselsatz auf Schiene  
Jeu de douilles sur rail



RS3340M/8-L75	8 Pieces Set/Rail 200mm	(g)
8, 10, 11, 12, 13, 14, 17, 19		810

# 3/8" Hand Sockets Hand Steckschlüssel Douilles à main

3430M (mm)	D (mm)	ℓ (mm)	L (mm)	(g)	(pcs.)
5	19	15.5	62	66	10
6	19	15.5	62	70	10
7	19	15.5	62	72	10
8	19	15.5	62	74	10
10	19	15.5	62	78	10
12	19	15.5	62	85	10

**3430M**  Universal Hex Sockets  
Gelenk-Einsätze für Schrauben mit Innensechskant  
Douilles articulées, 6-pans mâle

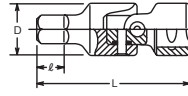

RS3430M/6	6 Pieces Set/Rail 150mm	(g)
5, 6, 7, 8, 10, 12		470

**RS3430M/6**   Socket Set on Rail  
Steckschlüsselsatz auf Schiene  
Jeu de douilles sur rail



**3117M-125/-250**  Extended Sockets  
Schaftsteckschlüssel  
Douilles rallongées

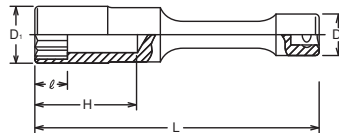

3117M-125 (mm)	D <sub>1</sub> (mm)	D <sub>2</sub> (mm)	ℓ (mm)	H (mm)	L (mm)	(g)	(pce.)
10	14.5	18	10	44	125	121	1
11	16	18	11	44	125	133	1
12	17	18	12	44	125	133	1
13	18	18	13	44	125	134	1
14	19.5	18	14	44	125	145	1
17	23.5	18	17	44	125	178	1
19	25	18	19	44	125	187	1
21	27	18	21	44	125	195	1
22	29	18	22	44	125	214	1

3117M-250 (mm)	D <sub>1</sub> (mm)	D <sub>2</sub> (mm)	ℓ (mm)	H (mm)	L (mm)	(g)	(pce.)
10	14.5	18	10	44	250	233	1
11	16	18	11	44	250	241	1
12	17	18	12	44	250	246	1
13	18	18	13	44	250	249	1
14	19.5	18	14	44	250	262	1
17	23.5	18	17	44	250	289	1
19	25	18	19	44	250	298	1
21	27	18	21	44	250	302	1
22	29	18	22	44	250	325	1



Z-SERIES  
HAND  
TITANIUM  
ACCESSORIES  
SCREWDRIVERS  
IMPACT  
SLEEVE-DRIVE  
PROTECTOR  
INDUSTRIAL  
AUTOMOTIVE  
MOTORCYCLE  
CONSTRUCTION  
SPARE PART

Z-SERIES  
HAND  
TITANIUM  
SCREWDRIVERS ACCESSORIES  
IMPACT  
SLEEVE-DRIVE  
PROTECTOR  
INDUSTRIAL  
AUTOMOTIVE  
MOTORCYCLE  
CONSTRUCTION  
SPARE PART

## 3000-60 (PH)

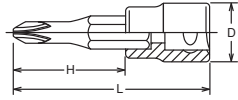
 Phillips Bit Sockets  
Steckschlüssel für Kreuzschlitzschrauben, Phillips  
Douilles tournevis pour vis à empreinte Phillips





3000 (PH)	D (mm)	H (mm)	L (mm)	 (g)	 (pcs.)
1	18	33.5	60	49	10
2	18	33.5	60	49	10
3	18	33.5	60	49	10
4	18	33.5	60	50	10

## 3000-50 (PZ)

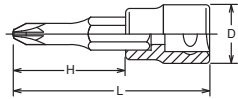
 PZ Bit Sockets  
Steckschlüssel für Kreuzschlitzschrauben, PZ  
Douilles tournevis pour vis à empreinte PZ









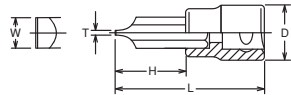







3000-50 (PZ)	D (mm)	H (mm)	L (mm)	 (g)	 (pcs.)
PZ1	18	23.5	50	50	10
PZ2	18	23.5	50	50	10
PZ3	18	23.5	50	50	10

## 3005-60

 Bit Sockets for Slotted Heads  
Steckschlüssel für Schlitzschrauben  
Douilles tournevis pour vis à fente



3005	T×W (mm)	D (mm)	H (mm)	L (mm)	 (g)	 (pcs.)
5	1.0× 5.5	18	33.5	60	47	10
8	1.2× 8	18	33.5	60	49	10
10	1.6×10	20	33.5	60	85	10

	 Phillips (PH)	 PZ	 Slotted	 HEX	 HEX (ball point)	 Triple Square (XZN)	 TORX® (T)	 TORX® (TH)	 TORXPLUS® (IP)	 TORXPLUS® (IPR)	 Ribe-CV
1/4"	No.2000 series	No.2000(PZ) series	No.2005 series	No.2010M/A series	No.2011M series	No.2020 series	No.2025 series	No.2025(TH) series	No.2025(IP) series	No.2025(IPR) series	—
3/8"	No.3000 No.3001 series	No.3000(PZ) series	No.3005 No.3006 series	No.3010M/A No.3012M/A No.3015M series	No.3011M series	No.3020 series	No.3025 series	No.3025(TH) series	No.3025(IP) series	No.3025(IPR) series	No.3027 series
1/2"	No.4000 No.4001 series	No.4000(PZ) series	No.4005 No.4006 series	No.4010M/A No.4012M/A series	—	No.4020 series	No.4025 series	—	No.4025(IP) series	—	No.4027 series



## 3010M-38/-62/-100/-160 3010A-50

 Inhex Bit Sockets  
Steckschlüssel für Innensechskant-Schrauben  
Douilles tournevis pour vis 6-pans creux

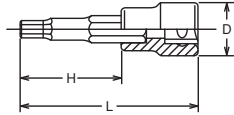

3010M-38 (mm)	D (mm)	H (mm)	L (mm)	(g)	(pcs.)
3	18	11.5	38	27	10
4	18	11.5	38	28	10
5	18	11.5	38	30	10
6	18	11.5	38	31	10
7	18	11.5	38	32	10
8	18	11.5	38	33	10
9	20	11.5	38	47	10
10	20	11.5	38	48	10
11	20	11.5	38	59	10
12	20	11.5	38	60	10
13	22	11.5	38	76	5
14	22	11.5	38	78	5





3010M-62 (mm)	D (mm)	H (mm)	L (mm)	(g)	(pcs.)
3	18	35.5	62	43	10
4	18	35.5	62	45	10
5	18	35.5	62	48	10
6	18	35.5	62	49	10
7	18	35.5	62	50	10
8	18	35.5	62	62	10
9	20	35.5	62	75	10
10	20	35.5	62	76	10
11	20	35.5	62	92	10
12	20	35.5	62	94	10
13	22	35.5	62	107	5
14	22	35.5	62	109	5

3010M-100 (mm)	D (mm)	H (mm)	L (mm)	(g)	(pcs.)
3	18	73.5	100	58	10
4	18	73.5	100	60	10
5	18	73.5	100	63	10
6	18	73.5	100	64	10
7	18	73.5	100	66	10
8	18	73.5	100	69	10
9	20	73.5	100	100	10
10	20	73.5	100	102	10
11	20	73.5	100	129	10
12	20	73.5	100	131	10
13	22	73.5	100	158	5
14	22	73.5	100	160	5

3010M-160 (mm)	D (mm)	H (mm)	L (mm)	(g)	(pcs.)
3	18	133.5	160	84	10
4	18	133.5	160	86	10
5	18	133.5	160	89	10
6	18	133.5	160	90	10
7	18	133.5	160	92	10
8	18	133.5	160	95	10
9	20	133.5	160	125	10
10	20	133.5	160	128	10
11	20	133.5	160	153	10
12	20	133.5	160	157	10
13	22	133.5	160	237	5
14	22	133.5	160	239	5

3010A-50 (inch)	D (mm)	H (mm)	L (mm)	(g)	(pcs.)
1/8	18	23.5	50	35	10
5/32	18	23.5	50	36	10
3/16	18	23.5	50	36	10
7/32	18	23.5	50	38	10
1/4	18	23.5	50	40	10
9/32	18	23.5	50	42	10
5/16	18	23.5	50	44	10
11/32	20	23.5	50	59	10
3/8	20	23.5	50	60	10
7/16	20	23.5	50	74	10
1/2	22	23.5	50	91	5

RS3010M/8-L38	8 Pieces Set/Rail 200mm	(g)
3, 4, 5, 6, 7, 8, 10, 12		322
RS3010M/8-L62	8 Pieces Set/Rail 200mm	(g)
3, 4, 5, 6, 7, 8, 10, 12		490
RS3010M/8-L100	8 Pieces Set/Rail 200mm	(g)
3, 4, 5, 6, 7, 8, 10, 12		645
RS3010A/8-L50	8 Pieces Set/Rail 200mm	(g)
1/8, 5/32, 3/16, 7/32, 1/4, 5/16, 3/8, 1/2		400

**RS3010M/8-L38**  Socket Set on Rail  
**RS3010M/8-L62**  Steckschlüsselsatz auf Schiene  
**RS3010M/8-L100**  Jeu de douilles sur rail  
**RS3010A/8-L50** 



Z-SERIES  
HAND  
TITANIUM  
ACCESSORIES  
SCREWDRIVERS  
IMPACT  
SLEEVE-DRIVE  
PROTECTOR  
INDUSTRIAL  
AUTOMOTIVE  
MOTORCYCLE  
CONSTRUCTION  
SPARE PART

## 3012M-25



Inhex Sockets  
Steckschlüssel für Innensechskant-Schrauben  
Douilles tournevis pour vis 6-pans creux

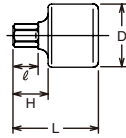

3012M-25 (inch)	D (mm)	ℓ (mm)	H (mm)	L (mm)	(g)	(pcs.)
New 3	18.5	5.5	10	25	22	10
New 4	18.5	5.5	10	25	22	10
New 5	18.5	6.5	10	25	22	10
New 6	18.5	7.5	10	25	23	10
New 7	18.5	10	-	25	24	10
New 8	18.5	10	-	25	25	10
New 10	18.5	10	-	25	27	10
New 12	18.5	10	-	25	30	10
14	19	10	-	25	30	10
17	19	10	-	25	30	10

For Lubrication Service  
Schmierdienst-Werkzeuge  
Service lubrification-vidange

## 3012M-52/-62/-75



Inhex Sockets  
Steckschlüssel für Innensechskant-Schrauben



## 3012A -52/-62/-75



Douilles tournevis pour vis 6-pans creux

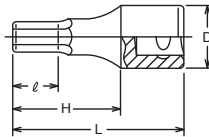

3012M/A are for hand use only.  
Do not use with a power or impact wrench.  
Bitte nicht auf Schlagschrauber oder anderen  
Maschinen gebrauchen.  
A ne pas utiliser sur des machines

3012M-52 (mm)	D (mm)	ℓ (mm)	H (mm)	L (mm)	(g)	(pcs.)
3	18	10	34	52	35	10
4	18	15.5	34	52	38	10
5	18	15.5	34	52	40	10
6	18	15.5	34	52	42	10
7	18	15.5	34	52	46	10
8	18.5	15.5	34	52	50	10
9	18.5	15.5	34	52	55	10
10	20	15.5	34	52	66	10
11	20	15.5	34	52	72	10
12	20	15.5	34	52	77	10
13	20	15.5	34	52	82	10
14	20	15.5	34	52	89	10

3012A-52 (inch)	D (mm)	ℓ (mm)	H (mm)	L (mm)	(g)	(pcs.)
1/8	18	10	34	52	35	10
5/32	18	15.5	34	52	38	10
3/16	18	15.5	34	52	40	10
7/32	18	15.5	34	52	42	10
1/4	18	15.5	34	52	44	10
9/32	18	15.5	34	52	46	10
5/16	18.5	15.5	34	52	50	10
11/32	18.5	15.5	34	52	55	10
3/8	20	15.5	34	52	65	10
7/16	20	15.5	34	52	72	10
1/2	20	15.5	34	52	82	10
9/16	20	15.5	34	52	89	10

3012M-62 (mm)	D (mm)	ℓ (mm)	H (mm)	L (mm)	(g)	(pcs.)
3	18	10	44	62	38	10
4	18	15.5	44	62	40	10
5	18	15.5	44	62	43	10
6	18	15.5	44	62	46	10
7	18	15.5	44	62	53	10
8	18.5	15.5	44	62	58	10
9	18.5	15.5	44	62	63	10
10	20	15.5	44	62	77	10
11	20	15.5	44	62	83	10
12	20	15.5	44	62	90	10
13	20	15.5	44	62	95	10
14	20	15.5	44	62	109	10

3012A-62 (inch)	D (mm)	ℓ (mm)	H (mm)	L (mm)	(g)	(pcs.)
1/8	18	10	44	62	38	10
5/32	18	15.5	44	62	40	10
3/16	18	15.5	44	62	43	10
7/32	18	15.5	44	62	46	10
1/4	18	15.5	44	62	48	10
9/32	18	15.5	44	62	53	10
5/16	18.5	15.5	44	62	58	10
11/32	18.5	15.5	44	62	63	10
3/8	20	15.5	44	62	73	10
7/16	20	15.5	44	62	83	10
1/2	20	15.5	44	62	95	10
9/16	20	15.5	44	62	109	10

3012M-75 (mm)	D (mm)	ℓ (mm)	H (mm)	L (mm)	(g)	(pcs.)
3	18	10	57	75	41	10
4	18	15.5	57	75	43	10
5	18	15.5	57	75	48	10
6	18	15.5	57	75	53	10
7	18	15.5	57	75	58	10
8	18.5	15.5	57	75	72	10
9	18.5	15.5	57	75	92	10
10	20	15.5	57	75	114	10
11	20	15.5	57	75	120	10
12	20	15.5	57	75	127	10
13	20	15.5	57	75	132	10
14	20	15.5	57	75	146	10

3012A-75 (inch)	D (mm)	ℓ (mm)	H (mm)	L (mm)	(g)	(pcs.)
1/8	18	10	57	75	41	10
5/32	18	15.5	57	75	43	10
3/16	18	15.5	57	75	48	10
7/32	18	15.5	57	75	53	10
1/4	18	15.5	57	75	53	10
9/32	18	15.5	57	75	58	10
5/16	18.5	15.5	57	75	72	10
11/32	18.5	15.5	57	75	92	10
3/8	20	15.5	57	75	110	10
7/16	20	15.5	57	75	120	10
1/2	20	15.5	57	75	132	10
9/16	20	15.5	57	75	146	10

3011M-62 (mm)	D (mm)	H (mm)	L (mm)	(g)	(pcs.)
3	18	35.5	62	45	10
4	18	35.5	62	46	10
5	18	35.5	62	48	10
6	18	35.5	62	49	10
7	18	35.5	62	50	10
8	18	35.5	62	51	10
10	20	35.5	62	66	10
12	20	35.5	62	79	10

3011M-100 (mm)	D (mm)	H (mm)	L (mm)	(g)	(pcs.)
3	18	73.5	100	61	10
4	18	73.5	100	62	10
5	18	73.5	100	64	10
6	18	73.5	100	65	10
7	18	73.5	100	67	10
8	18	73.5	100	68	10

3011M-120 (mm)	D (mm)	H (mm)	L (mm)	(g)	(pcs.)
3	18	93.5	120	77	10
4	18	93.5	120	78	10
5	18	93.5	120	80	10
6	18	93.5	120	81	10
7	18	93.5	120	83	10
8	18	93.5	120	84	10

3011M-160 (mm)	D (mm)	H (mm)	L (mm)	(g)	(pcs.)
3	18	133.5	160	87	10
4	18	133.5	160	88	10
5	18	133.5	160	89	10
6	18	133.5	160	91	10
7	18	133.5	160	93	10
8	18	133.5	160	95	10

**⚠** Ball point bit sockets have less strength due to the special design. Make sure to use them correctly.

3015M-62 (mm)	D (mm)	H (mm)	L (mm)	(g)	(pcs.)
3	18	35.5	62	43	10
4	18	35.5	62	45	10
5	18	35.5	62	50	10
6	18	35.5	62	50	10
7	18	35.5	62	50	10
8	18	35.5	62	62	10
10	20	35.5	62	75	10
12	20	35.5	62	95	10

3015M-100 (mm)	D (mm)	H (mm)	L (mm)	(g)	(pcs.)
3	18	73.5	100	60	10
4	18	73.5	100	60	10
5	18	73.5	100	65	10
6	18	73.5	100	65	10
7	18	73.5	100	70	10
8	18	73.5	100	70	10
10	20	73.5	100	105	10
12	20	73.5	100	135	10

Grip Ring holds hex screws

**⚠** Grip Ring bit sockets have less strength due to the special design. Make sure to use them correctly.

RS3015M/8-L62	8 Pieces Set/Rail 200mm	(g)
3, 4, 5, 6, 7, 8, 10, 12		500

RS3015M/8-L100	8 Pieces Set/Rail 200mm	(g)
3, 4, 5, 6, 7, 8, 10, 12		650

## 3011M-62/-100/-120/-160

**⚠** Ballpoint Inhex Sockets  
Steckschlüssel mit Kugelkopf, für Innensechskant-Schrauben  
Douilles tournevis avec tête sphérique pour vis 6-pans creux

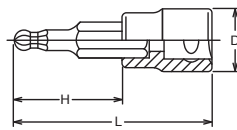

## 3015M-62/-100

**⚠** Inhex Bit Socket, Grip Ring  
Steckschlüssel für Innensechskant-Schrauben  
Douilles tournevis pour vis 6-pans creux

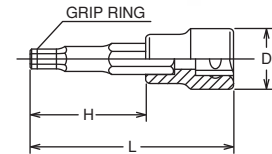

## RS3015M/8-L62

## RS3015M/8-L100

**⚠** Socket Set on Rail  
Steckschlüsselsatz auf Schiene  
Jeu de douilles sur rail



## 3020-38/-50/-100/-120



XZN Bit Sockets  
Steckschlüssel für XZN Schrauben  
Douilles tournevis pour empreinte XZN

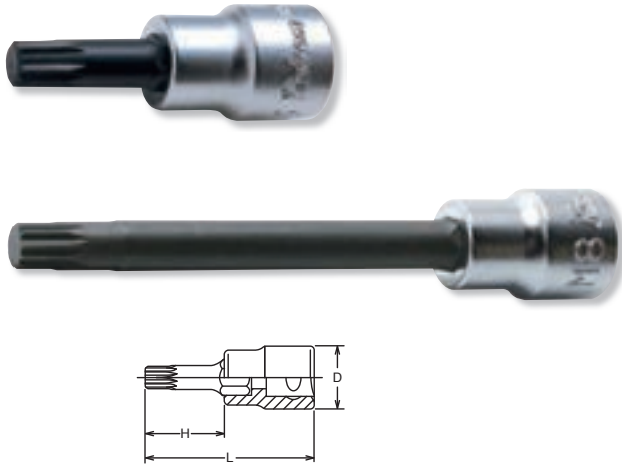

3020-38 (XZN)	D (mm)	H (mm)	L (mm)	(g)	(pcs.)
M 5	18	11.5	38	32	10
M 6	18	11.5	38	33	10
M 8	18	11.5	38	36	10
M10	20	11.5	38	51	10
M12	20	11.5	38	52	10
M14	22	11.5	38	74	10

3020-50 (XZN)	D (mm)	H (mm)	L (mm)	(g)	(pcs.)
M 4	18	23.5	50	35	10
M 5	18	23.5	50	37	10
M 6	18	23.5	50	39	10
M 8	18	23.5	50	40	10
M10	20	23.5	50	65	10
M12	20	23.5	50	69	10
M14	22	23.5	50	75	10

3020-100 (XZN)	D (mm)	H (mm)	L (mm)	(g)	(pcs.)
M 4	18	73.5	100	57	10
M 5	18	73.5	100	59	10
M 6	18	73.5	100	61	10
M 8	18	73.5	100	62	10
M10	20	73.5	100	99	10
M12	20	73.5	100	103	10
M14	22	73.5	100	145	5

3020-120 (XZN)	D (mm)	H (mm)	L (mm)	(g)	(pcs.)
M 4	18	93.5	120	77	10
M 5	18	93.5	120	79	10
M 6	18	93.5	120	81	10
M 8	18	93.5	120	82	10
M10	20	93.5	120	119	10
M12	20	93.5	120	123	10
M14	22	93.5	120	165	5

### XZN

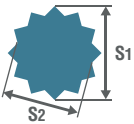

XZN		M4	M5	M6	M8	M10	M12	M14	M16	M18
S <sub>1</sub>	(ref. mm)	3.6	4.8	6.1	7.3	9.7	11.5	13.3	15.7	16.9
S <sub>2</sub>	(ref. mm)	3.1	4.1	5.1	6.1	8.1	9.7	11.2	13.2	14.2

## RS3020/6-L38



Socket Set on Rail  
Steckschlüsselsatz auf Schiene  
Jeu de douilles sur rail



RS3020/6-L38	6 Pieces Set/Rail 150mm	(g)
M5, M6, M8, M10, M12, M14		308

## RS3020/7-L50



Socket Set on Rail  
Steckschlüsselsatz auf Schiene  
Jeu de douilles sur rail



RS3020/7-L50	7 Pieces Set/Rail 200mm	(g)
M4, M5, M6, M8, M10, M12, M14		400

3025-38 (T)	D (mm)	H (mm)	L (mm)	(g)	(pcs.)
<b>New</b> T 8	18	11.5	38	32	10
T 9	18	11.5	38	32	10
T10	18	11.5	38	32	10
T15	18	11.5	38	33	10
T20	18	11.5	38	33	10
T25	18	11.5	38	33	10
T27	18	11.5	38	33	10
T30	18	11.5	38	33	10
T40	18	11.5	38	34	10
T45	18	11.5	38	37	10
T50	20	11.5	38	49	10
T55	20	11.5	38	57	10

3025-50 (T)	D (mm)	H (mm)	L (mm)	(g)	(pcs.)
<b>New</b> T 8	18	23.5	50	36	10
T 9	18	23.5	50	36	10
T10	18	23.5	50	36	10
T15	18	23.5	50	36	10
T20	18	23.5	50	36	10
T25	18	23.5	50	37	10
T27	18	23.5	50	37	10
T30	18	23.5	50	38	10
T40	18	23.5	50	39	10
T45	18	23.5	50	41	10
T50	20	23.5	50	55	10
T55	20	23.5	50	67	10

## 3025-38/-50/-140 (T) TORX® Bit Sockets TORX® Bit-Steckschlüssel Douilles tournevis, TORX®

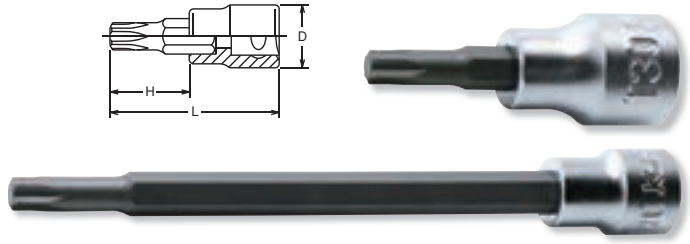

3025-140 (T)	D (mm)	H (mm)	L (mm)	(g)	(pcs.)
T 9	18	113.5	140	75	10
T10	18	113.5	140	75	10
T15	18	113.5	140	75	10
T20	18	113.5	140	75	10
T25	18	113.5	140	76	10
T27	18	113.5	140	76	10
T30	18	113.5	140	77	10
T40	18	113.5	140	78	10
T45	18	113.5	140	80	10
T50	20	113.5	140	94	10
T55	20	113.5	140	106	10

### TORX® (T)

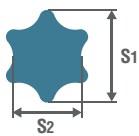

T	T8	T9	T10	T15	T20	T25	T27	T30	T40	T45	T50	T55	T60	T70	T80	T90	T100
S <sub>1</sub> (ref. mm)	2.3	2.5	2.7	3.3	3.9	4.5	5.0	5.6	6.7	7.9	8.9	11.3	13.3	15.6	17.6	20.0	22.2
S <sub>2</sub> (ref. mm)	1.7	1.8	2.0	2.3	2.8	3.2	3.6	4.0	4.8	5.6	6.2	8.0	9.5	11.1	12.7	14.2	15.8

RS3025/8-L38	8 Pieces Set/Rail 200mm	(g)
T10, T15, T20, T25, T27, T30, T40, T45		300

RS3025/8-L50	8 Pieces Set/Rail 200mm	(g)
T10, T15, T20, T25, T27, T30, T40, T45		320

3025-50 (T)	D (mm)	H (mm)	L (mm)	(g)	(pcs.)
T35	18	23.5	50	39	10

3025-100R (T)	D (mm)	H (mm)	L (mm)	(g)	(pcs.)
T20	18	73.5	100	38	10
T25	18	73.5	100	40	10
T27	18	73.5	100	42	10
T30	18	73.5	100	45	10
T40	18	73.5	100	52	10
T45	18	73.5	100	73	10
T50	20	73.5	100	80	10
T55	20	73.5	100	106	10

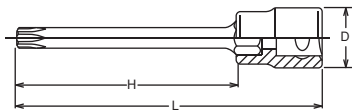

RS3025/8-L100R	8 Pieces Set/Rail 200mm	(g)
T20, T25, T27, T30, T40, T45, T50, T55		490

## RS3025/8-L38/-L50 (T)

Socket Set on Rail  
Steckschlüsselsatz auf Schiene  
Jeu de douilles sur rail



## 3025-50-T35 Bit Socket Bit-Steckschlüssel Douilles tournevis



## 3025-100R (T) TORX® Bit Sockets, round-shaft TORX® Bit-Steckschlüssel mit Rundschaft Douilles tournevis TORX® avec manche ronde



## RS3025/8-L100R

Socket Set on Rail  
Steckschlüsselsatz auf Schiene  
Jeu de douilles sur rail



Z-SERIES  
HAND  
TITANIUM  
SCREWDRIVERS ACCESSORIES  
IMPACT  
SLEEVE-DRIVE  
PROTECTOR  
INDUSTRIAL  
AUTOMOTIVE  
MOTORCYCLE  
CONSTRUCTION  
SPARE PART

## 3025-50/-160 (TH)

 Tamper Resistant TORX® Bit Sockets  
Tamper Resistant TORX® Bit-Steckschlüssel  
Douilles tournevis, Tamper-Resistant TORX®



 Tamper Resistant TORX® Bit Sockets have less strength due to special design. Make sure to use it correctly.



Bitte beachten Sie die geringere Belastbarkeit der Tamper Resistant Torx Steckschlüssel.

Veuillez respecter la moindre capacité inférieure de charge des douilles Tamper Resistant Torx.

3025-50 (TH)	D (mm)	H (mm)	L (mm)	(g)	(pcs.)
T10H	18	23.5	50	37	10
T15H	18	23.5	50	38	10
T20H	18	23.5	50	38	10
T25H	18	23.5	50	38	10
T27H	18	23.5	50	38	10
T30H	18	23.5	50	39	10
T40H	18	23.5	50	40	10
T45H	18	23.5	50	41	10
T50H	20	23.5	50	61	10
T55H	20	23.5	50	61	10

3025-160 (TH)	D (mm)	H (mm)	L (mm)	(g)	(pcs.)
T25H	18	133.5	160	83	10
T27H	18	133.5	160	83	10
T30H	18	133.5	160	84	10
T40H	18	133.5	160	85	10
T45H	18	133.5	160	86	10
T50H	20	133.5	160	128	10
T55H	20	133.5	160	128	10

## RS3025/9-L50 (TH)

  Socket Set on Rail  
Steckschlüsselsatz auf Schiene  
Jeu de douilles sur rail



RS3025/9-HOLE	9 Pieces Set/Rail 200mm	(g)
T10H, T15H, T20H, T25H, T27H, T30H, T40H, T45H, T50H		405

## 3247

 Bit Socket Set  
Schraubendreher-Steckschlüssel Satz  
Jeu de douilles de vissage



3247	4 Pieces Set/ =385g
PLASTIC BAG	
Sockets	
 3025.160 Tamper-Resistant TORX® Bit Sockets	T27H, T30H, T40H, T50H

## 3025-100R (TH)



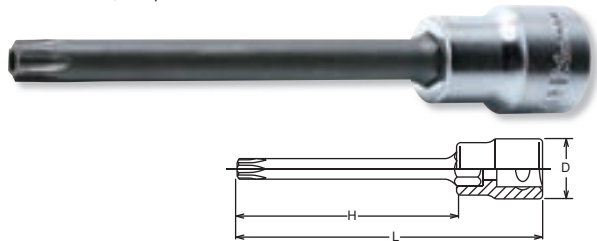

Tamper-Resistant TORX® Bit Sockets, round-shaft  
Tamper-Resistant TORX® Bit-Steckschlüssel mit Rundschaft  
Douilles tournevis, Tamper-Resistant TORX® avec manche ronde



3025-100R (TH)	D (mm)	H (mm)	L (mm)	(g)	(pcs.)
T20H	18	73.5	100	38	10
T25H	18	73.5	100	40	10
T27H	18	73.5	100	42	10
T30H	18	73.5	100	45	10
T40H	18	73.5	100	52	10
T45H	18	73.5	100	73	10
T50H	20	73.5	100	80	10
T55H	20	73.5	100	106	10

## RS3025/8-L100RH

  Socket Set on Rail  
Steckschlüsselsatz auf Schiene  
Jeu de douilles sur rail



RS3025/8-L100RH	8 Pieces Set/Rail 200mm	(g)
T20H, T25H, T27H, T30H, T40H, T45H, T50H, T55H		490

# 3/8"

Hand Sockets  
Hand Steckschlüssel  
Douilles à main

3025-50 (IP)	D (mm)	H (mm)	L (mm)	(g)	(pcs.)
10IP	18	23.5	50	38	10
15IP	18	23.5	50	38	10
20IP	18	23.5	50	38	10
25IP	18	23.5	50	38	10
27IP	18	23.5	50	40	10
30IP	18	23.5	50	40	10
40IP	18	23.5	50	41	10
45IP	18	23.5	50	41	10
50IP	20	23.5	50	61	10
55IP	20	23.5	50	61	10

## 3025-50 (IP)

TORXPLUS® Bit Sockets  
TORXPLUS® Bit-Steckschlüssel  
Douilles tournevis, TORXPLUS®

**TORXplus**

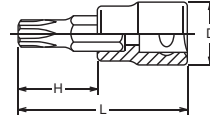

### TORXPLUS® (IP)

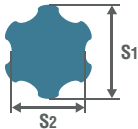

IP	8IP	9IP	10IP	15IP	20IP	25IP	27IP	30IP	40IP	45IP	50IP	55IP	60IP	70IP
S <sub>1</sub> (ref. mm)	2.3	2.5	2.7	3.3	3.9	4.5	5.0	5.6	6.7	7.9	8.9	11.3	13.3	15.6
S <sub>2</sub> (ref. mm)	1.7	1.8	2.0	2.3	2.8	3.2	3.6	4.0	4.8	5.6	6.2	8.0	9.5	11.1

RS3025/8-IP	8 Pieces Set/Rail 200mm	(g)
20IP, 25IP, 27IP, 30IP, 40IP, 45IP, 50IP, 55IP		370

## RS3025/8 (IP)

Socket Set on Rail  
Steckschlüsselsatz auf Schiene  
Jeu de douilles sur rail



RSX025/11-IP	11 Pieces Set/Rail 200mm	(g)
2025.28(IP)	10IP, 15IP, 20IP, 25IP, 27IP	480
3025.50(IP)	30IP, 40IP, 45IP, 50IP	
4025.60(IP)	55IP, 60IP	

## RSX025/11 (IP)

Socket Set on Rail  
Steckschlüsselsatz auf Schiene  
Jeu de douilles sur rail



$$\boxed{1/4"} + \boxed{3/8"} + \boxed{1/2"} = \text{Total Length}$$

# TORXplus®

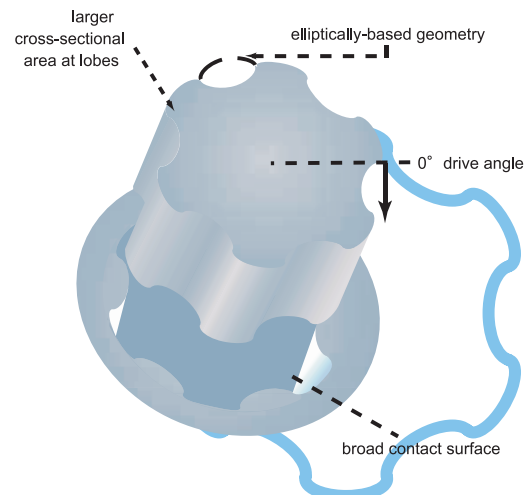
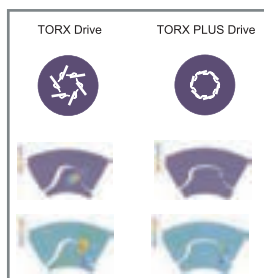
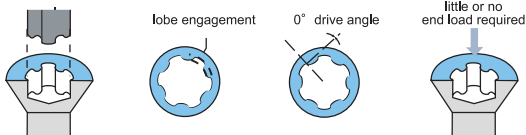

## 3025-50 (IPR)



TORXPLUS® Bit Sockets, with hole  
TORXPLUS® Bit-Steckschlüssel mit Stirnbohrung  
douilles tournevis TORXPLUS® avec trou

**TORXplus®**

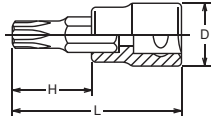

3025-50 (IPR)	D (mm)	H (mm)	L (mm)	(g)	(pcs.)
10IPR	18	23.5	50	38	10
15IPR	18	23.5	50	38	10
20IPR	18	23.5	50	38	10
25IPR	18	23.5	50	38	10
27IPR	18	23.5	50	40	10
30IPR	18	23.5	50	40	10
40IPR	18	23.5	50	41	10
45IPR	18	23.5	50	41	10
50IPR	20	23.5	50	61	10
55IPR	20	23.5	50	61	10

### TORXPLUS® (IPR)

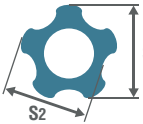

IPR	8IPR	9IPR	10IPR	15IPR	20IPR	25IPR	27IPR	30IPR	40IPR	45IPR	50IPR	55IPR
S <sub>1</sub> (ref. mm)	2.2	2.4	2.6	3.1	3.6	4.1	4.7	5.2	6.3	7.4	8.4	10.6
S <sub>2</sub> (ref. mm)	2.0	2.2	2.4	2.8	3.3	3.8	4.3	4.8	5.7	6.7	7.6	9.7

## RS3025/9 (IPR)



Socket Set on Rail  
Steckschlüsselsatz auf Schiene  
Jeu de douilles sur rail



RS3025/9-IPR	9 Pieces Set/Rail 200mm	(g)
10IPR, 15IPR, 20IPR, 25IPR, 27IPR, 30IPR, 40IPR, 45IPR, 50IPR		395

## RSX025/11 (IPR)



Socket Set on Rail  
Steckschlüsselsatz auf Schiene  
Jeu de douilles sur rail



RSX025/11-IPR	11 Pieces Set/Rail 200mm	(g)
2025.28(IPR)	8IPR, 10IPR, 15IPR, 20IPR, 25IPR, 27IPR, 30IPR	320
3025.50(IPR)	40IPR, 45IPR, 50IPR, 55IPR	

1/4" + 3/8"

## 3027-50/-100



Bit Sockets for Ribe Screws  
Steckschlüsselklingen für Ribe Schrauben  
Douilles tournevis pour écrous profil Ribe

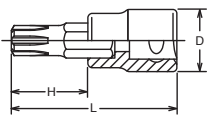

3027-50	D (mm)	H (mm)	L (mm)	(g)	(pcs.)
M 5	18	23.5	50	38	10
M 6	18	23.5	50	38	10
M 7	18	23.5	50	38	10
M 8	18	23.5	50	39	10
M 9	20	23.5	50	40	10
M10	20	23.5	50	40	10
M12	20	23.5	50	41	10

3027-100	D (mm)	H (mm)	L (mm)	(g)	(pcs.)
M 5	18	73.5	100	40	10
M 6	18	73.5	100	42	10
M 8	18	73.5	100	45	10
M10	20	73.5	100	52	10
M12	20	73.5	100	73	10

### Ribe CV

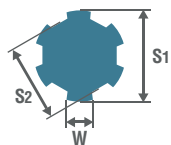

CV	M5	M6	M7	M8	M9	M10	M12	M13	M14	M16
W (ref. mm)	1.2	1.3	1.4	1.8	2.0	2.3	2.6	3.1	3.2	3.6
S <sub>1</sub> (ref. mm)	5.0	6.0	7.0	8.0	9.0	10.0	12.0	13.0	14.0	16.0
S <sub>2</sub> (ref. mm)	3.8	4.5	5.0	6.0	7.1	7.4	9.0	11.0	10.4	11.9

## RS3027/5-L50



Socket Set on Rail  
Steckschlüsselsatz auf Schiene  
Jeu de douilles sur rail



RS3027/5-L50	5 Pieces Set/Rail 150mm	(g)
M5, M6, M8, M10, M12		240



3110M (mm)		D (mm)	ℓ (mm)	L (mm)	(g)	(pcs.)
6		18	10	28	30	10
8	3/8"	18	10	28	30	10
10		18	10	28	33	10
12		18	10	28	37	10

3110A (inch)		D (mm)	ℓ (mm)	L (mm)	(g)	(pcs.)
5/16	3/8"	18	10	28	30	10
3/8		18	10	28	33	10
1/2		18	10	28	37	10

		D <sub>1</sub> (mm)	D <sub>2</sub> (mm)	L (mm)	(g)	(pcs.)
3137	3/8"	13	16.5	30	30	10

For DIN3126 C6.3 Bits  
Für DIN3126 C6.3 Bits  
Pour DIN3126 C6.3 Embouts

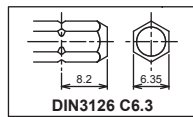

DIN3126 C6.3



		D <sub>1</sub> (mm)	D <sub>2</sub> (mm)	L (mm)	(g)	(pcs.)
3138	3/8"	16	18	38	55	10

For DIN3126 C8 Bits  
Für DIN3126 C8 Bits  
Pour DIN3126 C8 Embouts

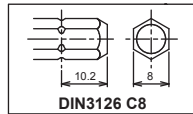

DIN3126 C8



		D <sub>1</sub> (mm)	D <sub>2</sub> (mm)	L (mm)	(g)	(pcs.)
3141	3/8"	16	18	48	60	10

## 3110M / 3110A

4-point Male Sockets  
Öldienst-Steckschlüssel  
Douilles mâles 4-pans

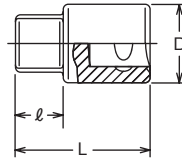

## 3137

Bit Holder  
Klingenhalter  
Porte-embouts

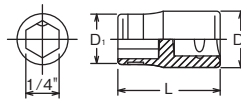

## 3138

Bit Holder  
Klingenhalter  
Porte-embouts

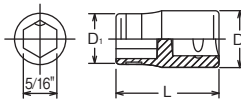

## 3141

Bit Holder, extra deep for 131P-80, 131S-80, 131T-80  
Klingenhalter, extra tief für 131P-80, 131S-80, 131T-80  
Porte-embouts, ouverture longue pour 131P-80, 131S-80, 131T-80

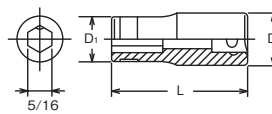

Z-SERIES  
HAND  
TITANIUM  
SCREWDRIVERS ACCESSORIES  
IMPACT  
SLEEVE-DRIVE  
PROTECTOR  
INDUSTRIAL  
AUTOMOTIVE  
MOTORCYCLE  
CONSTRUCTION  
SPARE PART

### 2749PS-3/8

Reversible Ratchet (Short)  
Knarre kurz, verstellbar  
Cliquet courte, réversible

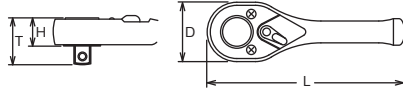

\* Renewal Kits → 2749RK-3/8 → P298

	D (mm)	T (mm)	H (mm)	L (mm)	(g)	(pcs.)
2749PS-3/8	25	21.9	11.2	75	70	10

### 2749P-3/8

Reversible Ratchet  
Knarre, verstellbar  
Cliquet, réversible

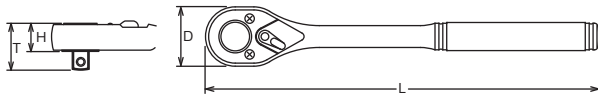

\* Renewal Kits → 2749RK-3/8 → P298

	D (mm)	T (mm)	H (mm)	L (mm)	(g)	(pcs.)
2749P-3/8	25	21.9	11.2	125	101	10

2749-3/8 series have less strength compared with normal [38] ratchet due to the technical design. Make sure to use the ratchet correctly.

### 3749S

Reversible Ratchet (Short)  
Knarre kurz, verstellbar  
Cliquet courte, réversible



\* Renewal Kits → 3749RK → P298

### 3749SB

Reversible Ratchet with quick release button  
Knarre, verstellbar mit Verriegelungsknopf  
Cliquet, réversible avec bouton de débrayage

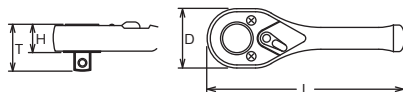

\* Renewal Kits → 3749BRK → P298

	D (mm)	T (mm)	H (mm)	L (mm)	(g)	(pcs.)
3749S	34	24.8	14.1	110	183	5
3749SB	34	24.8	14.1	110	183	5

Reversible Ratchet with quick release button has less strength compared with normal ratchet due to the technical design. Make sure to use the ratchet correctly.

### 3753SM

Multi Purpose Ratchet, reversible  
Knarre mit 2 Vierkantöffnungen, umstellbar  
Cliquet réversible deux carrés femelles, réversibles

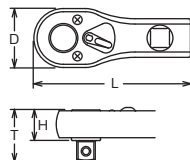

\* Renewal Kits → 3753RK → P298

	D (mm)	T (mm)	H (mm)	L (mm)	(g)	(pcs.)
3753SM	30.5	26.4	15.7	81	175	5

### 3753SMB

Multi Purpose Ratchet, reversible, with quick release button  
Knarre mit 2 Vierkantöffnungen, mit Verriegelungsknopf, umstellbar  
Cliquet réversible deux carrés, avec bouton de débrayage

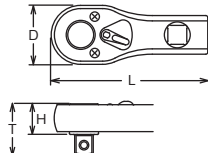

\* Renewal Kits → 3753BRK → P298

	D (mm)	T (mm)	H (mm)	L (mm)	(g)	(pcs.)
3753SMB	30.5	26.4	15.7	81	175	5



## [L/R Marking]



\* Renewal Kits → 3752RK → P298



\* Renewal Kits → 3752RK → P298

A pointer and L/R markings on the ratchet head indicate the turning direction. The reduced diameter of the head allows easier access in tight spots.

Eine L/R Markierung auf dem Knarrenkopf zeigt die gerade eingestellte Drehrichtung an. Der geringe Kopfdurchmesser erleichtert das Arbeiten auch an schwer zugänglichen Stellen.

Un marquage L/R sur la tête de cliquet indique le sens de rotation. Le diamètre de tête réduit facilite le travail dans les endroits difficilement accessibles.

	D (mm)	T (mm)	H (mm)	L (mm)	(g)	(pce.)
3752J	33	34.3	23.9	200	310	1
3752N	33	34.3	23.9	200	310	1

**3752J** Reversible Ratchet  
Knarre, verstellbar  
Cliquet, réversible



**3752N** Reversible Ratchet  
Knarre, verstellbar  
Cliquet, réversible

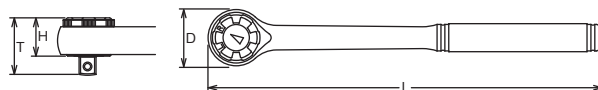

**3753J** Reversible Ratchet  
Knarre, verstellbar  
Cliquet, réversible



**3753P** Reversible Ratchet  
Knarre, verstellbar  
Cliquet, réversible



**3753N** Reversible Ratchet  
Knarre, verstellbar  
Cliquet, réversible



**D3753J** Reversible Ratchet  
Knarre, verstellbar  
Cliquet, réversible

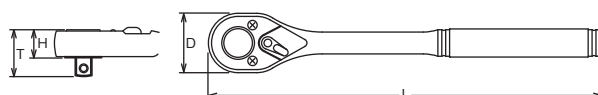

\* Renewal Kits → 3753RK → P298



\* Renewal Kits → 3753RK → P298



\* Renewal Kits → 3753RK → P298



\* Renewal Kits → 3753RK → P298

	D (mm)	T (mm)	H (mm)	L (mm)	(g)	(pce.)
3753J	30.5	26.4	15.7	200	260	1
3753P	30.5	26.4	15.7	200	286	1
3753N	30.5	26.4	15.7	200	320	1
D3753J	30.5	26.4	15.7	200	260	1



\* Renewal Kits → 3753RK → P298

**3753P-250** Reversible Ratchet (Long)  
Verstellbare Knarre, lang  
Cliquet réversible, long



	D (mm)	T (mm)	H (mm)	L (mm)	(g)	(pce.)
3753P-250	30.5	26.4	15.7	250	335	1

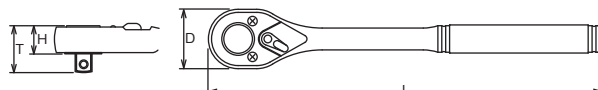

# Hand Sockets Hand Steckschlüssel Douilles à main

## 3/8"

Z-SERIES

HAND

TITANIUM

SCREWDRIVERS ACCESSORIES

IMPACT

SLEEVE-DRIVE

PROTECTOR

INDUSTRIAL

AUTOMOTIVE

MOTORCYCLE

CONSTRUCTION

SPARE PART

**3753JB** Reversible Ratchet with quick release button  
Knarre, verstellbar mit Verriegelungsknopf  
Cliquet, réversible avec bouton de débrayage



\* Renewal Kits → 3753BRK → P298

**3753PB** Reversible Ratchet with quick release button  
Knarre, verstellbar mit Verriegelungsknopf  
Cliquet, réversible avec bouton de débrayage



\* Renewal Kits → 3753BRK → P298

**3753NB** Reversible Ratchet with quick release button  
Knarre, verstellbar mit Verriegelungsknopf  
Cliquet, réversible avec bouton de débrayage



\* Renewal Kits → 3753BRK → P298

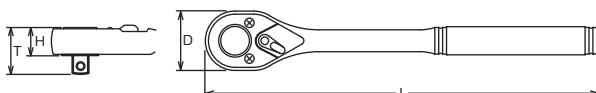

⚠ Reversible Ratchet with quick release button has less strength compared with normal ratchet due to the technical design. Make sure to use the ratchet correctly.

	D (mm)	T (mm)	H (mm)	L (mm)	(g)	(pcs.)
3753JB	30.5	26.4	15.7	200	260	1
3753PB	30.5	26.4	15.7	200	286	1
3753NB	30.5	26.4	15.7	200	320	1

**2774JS-3/8** Flexible Ratchet, reversible  
Gelenk-Knarre, verstellbar



\* Renewal Kits → 2749RK-3/8 → P298

**2774PS-3/8** Flexible Ratchet, reversible  
Gelenk-Knarre, verstellbar  
Cliquet articulé, réversible



\* Renewal Kits → 2749RK-3/8 → P298

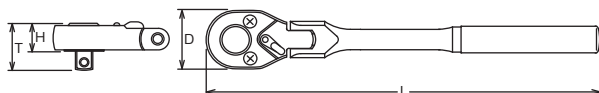

	D (mm)	T (mm)	H (mm)	L (mm)	(g)	(pcs.)
2774JS-3/8	25	21.9	11.2	120	113	5
2774PS-3/8	25	21.9	11.2	120	133	5

⚠ 2774-3/8 series have less strength compared with normal 387 ratchet due to the technical design. Make sure to use the ratchet correctly.

**3774PS** Flexible Ratchet, reversible  
Gelenk-Knarre, verstellbar  
Cliquet articulé, réversible



\* Renewal Kits → 3753RK → P298

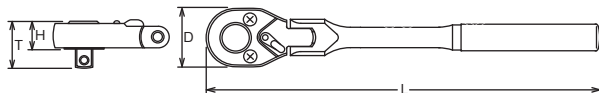

	D (mm)	T (mm)	H (mm)	L (mm)	(g)	(pcs.)
3774PS	30.5	26.4	15.7	175	250	2

# 3/8" Hand Sockets Hand Steckschlüssel Douilles à main

Z-SERIES  
HAND  
TITANIUM  
ACCESSORIES  
SCREWDRIVERS  
IMPACT  
SLEEVE-DRIVE  
PROTECTOR  
INDUSTRIAL  
AUTOMOTIVE  
MOTORCYCLE  
CONSTRUCTION  
SPARE PART



**3774J** Flexible Ratchet, reversible  
Gelenk-Knarre, verstellbar  
Cliquet articulé, réversible

\* Renewal Kits → 3753RK → P298



**3774P** Flexible Ratchet, reversible  
Gelenk-Knarre, verstellbar  
Cliquet articulé, réversible

\* Renewal Kits → 3753RK → P298



**3774N** Flexible Ratchet, reversible  
Gelenk-Knarre, verstellbar  
Cliquet articulé, réversible

\* Renewal Kits → 3753RK → P298

	D (mm)	T (mm)	H (mm)	L (mm)	(g)	(pcs.)
<b>3774J</b>	30.5	26.4	15.7	285	367	1
<b>3774P</b>	30.5	26.4	15.7	265	378	2
<b>3774N</b>	30.5	26.4	15.7	265	378	2

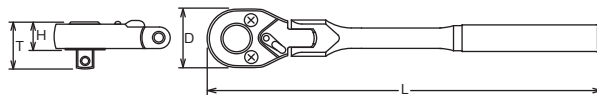

\* Renewal Kits → 3753BRK → P298

**3774JB**  
**3774PB**  
**3774NB**

Flexible Ratchet, reversible with quick release button  
Gelenk-Knarre, verstellbar mit Verriegelungsknopf  
Cliquet, articulée, réversible avec bouton de débrayage



	D (mm)	T (mm)	H (mm)	L (mm)	(g)	(pcs.)
<b>3774JB</b>	30.5	26.4	15.7	285	367	1
<b>3774PB</b>	30.5	26.4	15.7	265	373	2
<b>3774NB</b>	30.5	26.4	15.7	265	378	2

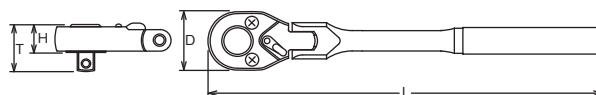

Reversible Ratchet with quick release button has less strength compared with normal ratchet due to the technical design. Make sure to use the ratchet correctly.

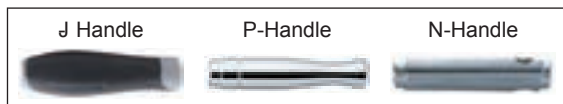

**Reversible Ratchet with Quick Release Button :**  
Sockets and accessories are safely locked. By pushing the button the sockets or extension bars are released from the ratchet.

**Umstellbare Knarre mit Verriegelungsknopf :**  
Steckschlüssel und Zubehörteile werden sicher und fest gehalten. Bei Drücken des Knopfes lösen sich die Teile.

**Cliquet réversible à verrouillage :**  
Les douilles et accessoires ne peuvent plus se libérer. Une pression du pouce sur le bouton suffit pour les extraire.



\* Renewal Kits → 3753RK → P298

**3774JL**  
**3774PL**  
**3774NL**

Flex-Head Ratchet with Head Lock Button  
Gelenk-Knarre, mit feststellbarem Gelenk  
Cliquet à tête articulée avec bouton de blocage



	D (mm)	T (mm)	H (mm)	L (mm)	(g)	(pcs.)
<b>3774JL</b>	30.5	26.4	15.7	285	367	1
<b>3774PL</b>	30.5	26.4	15.7	265	378	2
<b>3774NL</b>	30.5	26.4	15.7	265	378	2

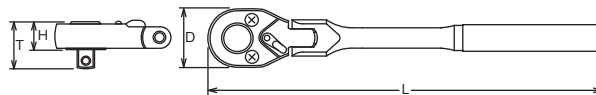

Reversible Ratchet with quick release button has less strength compared with normal ratchet due to the technical design. Make sure to use the ratchet correctly.

Z-SERIES  
HAND  
TITANIUM  
SCREWDRIVERS ACCESSORIES  
IMPACT  
SLEEVE-DRIVE  
PROTECTOR  
INDUSTRIAL  
AUTOMOTIVE  
CONSTRUCTION MOTORCYCLE  
SPARE PART

**3774JBL** Flex-Head Ratchet with Head Lock Button and Quick Release Button  
Gelenk-Knarre, mit feststellbarem Gelenk und Verriegelungsknopf  
Cliquet à tête articulée avec bouton de blocage et de débrayage



\* Renewal Kits → **3753BRK** → **P298**

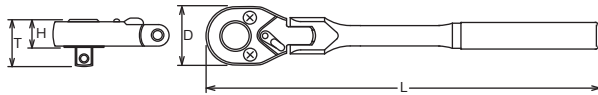
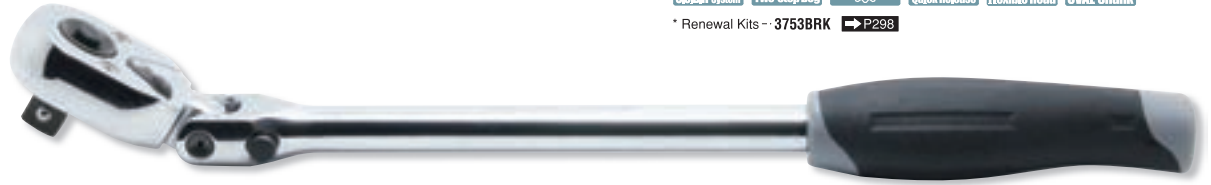

	D (mm)	T (mm)	H (mm)	L (mm)	(g)	(pce.)
<b>3774JBL</b>	30.5	26.4	15.7	285	367	1

⚠ Reversible Ratchet with quick release button has less strength compared with normal ratchet due to the technical design. Make sure to use the ratchet correctly.

**3774P-SR** Speeder Ratchet  
Kurbel-Knarre  
Vilebrequin à cliquet



\* Renewal Kits → **3753RK** → **P298**

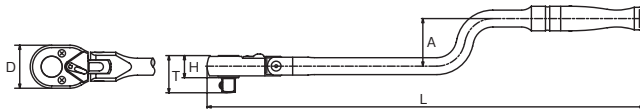

	D (mm)	T (mm)	H (mm)	A (mm)	L (mm)	(g)	(pce.)
<b>3774P-SR</b>	30.5	26.4	15.7	34	310	435	1

**3776J** Swivel Head Ratchet  
Schwenkopf-Knarre  
Cliquet à tête pivotante



\* Renewal Kits → **3752RK** → **P298**



**3776P** Swivel Head Ratchet  
Schwenkopf-Knarre  
Cliquet à tête pivotante



\* Renewal Kits → **3752RK** → **P298**

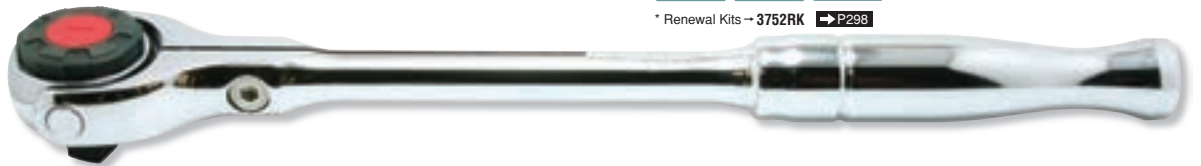

**3776N** Swivel Head Ratchet  
Schwenkopf-Knarre  
Cliquet à tête pivotante



\* Renewal Kits → **3752RK** → **P298**

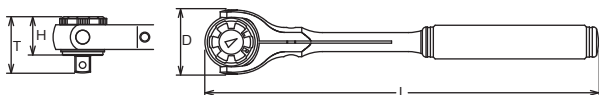

	D (mm)	T (mm)	H (mm)	L (mm)	(g)	(pce.)
<b>3776J</b>	44	34.3	23.9	280	510	1
<b>3776P</b>	44	34.3	23.9	280	560	1
<b>3776N</b>	44	34.3	23.9	280	565	1

45

\* Renewal Kits → 3755RK → P300

	D (mm)	L (mm)	(g)	(pcs.)
3755	30.5	55	146	5

**3755** Ratchet Adaptor  
Aufsteckknarre  
Cliquet adaptable

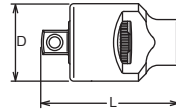

	D (mm)	L (mm)	(g)	(pcs.)
3756	30.5	25.5	47	10

**3756** Quick Spinner  
Rändel-Drehscheibe  
Lanceur

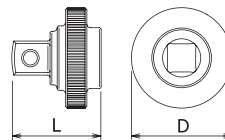

L/R Marking  
45

\* Renewal Kits → 3752RK → P298

	D (mm)	L (mm)	(g)	(pcs.)
3757	50	35	155	5

**3757** Ratchet Wheel  
Umstellbares Knarren-Handrad  
Cliquet réversible à roue

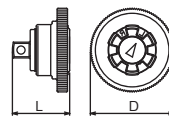

	D (mm)	L (mm)	(g)	(pcs.)
3762	19.3	300	178	2

**3762** Flexible Extension Bar  
Biegsame Verlängerung  
Rallonge flexible

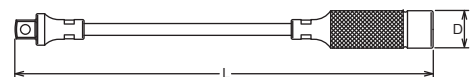

## 3760-32/-50/-75/-125/-150/-250/-300/ -400/-500/-600/-900/-1000

Extension Bars  
Verlängerungen  
Rallonges

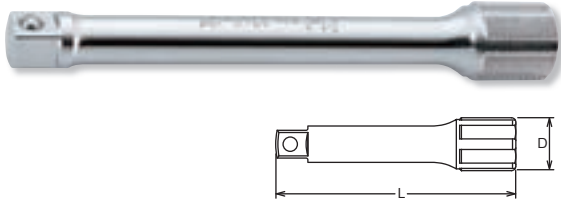

3760	D (mm)	L (mm)	(g)	(pcs.)
32	18	32	27	10
50	18	50	47	10
75	18	75	68	10
125	18	125	106	10
150	18	150	125	10
250	18	250	196	5
300	18	300	291	2
400	18	400	365	1
500	18	500	490	1
600	18	600	538	1
900	18	900	805	1
1000	18	1000	968	1

### PK3760/6

Extension Set in Plastic Box  
Verlängerungen in Kunststoffkassette  
Jeu de rallonges en boîte plastique



PK3760/6 6 Pieces Set/△=670g

PLASTIC TRAY

Extension Bars

3760 Extension Bars  
32, 50, 75, 125, 150, 250

Rotation and general handling of extensions with oily hands is greatly improved with the **Koken** developed 6 point knurling. Also the **Koken** 6 point knurling stops the extensions from rolling around the work area.

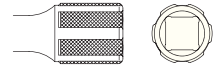

Durch die von **Koken** entwickelte 6 fache Rändelung wird die Handhabung deutlich erleichtert. Außerdem wird das Herumrollen der Verlängerungen wirksam verhindert.

La manipulation des rallonges est grandement facilitée par le profil moleté développé par **Koken**. Ce même profil empêche le roulement intempestif des rallonges sur le plan de travail.

## 3763-32/-50/-75/-125/-150/-250/-300

Wobble-Fix Extension Bars  
Winkel-Verlängerungen  
Rallonges angulaires

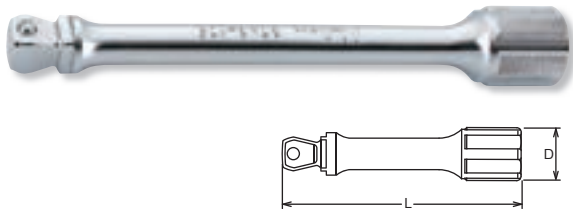

3763	D (mm)	L (mm)	(g)	(pcs.)
32	18	32	26	10
50	18	50	42	10
75	18	75	57	10
125	18	125	80	10
150	18	150	98	10
250	18	250	144	5
300	18	300	170	2

### PK3763/6

Wobble-Fix Extension Bars in Plastic Box  
Winkel-Verlängerungen in Kunststoffkassette  
Jeu de rallonges angulaires en boîte plastique



PK3763/6 6 Pieces Set/△=560g

PLASTIC TRAY

Extension Bars

3763 Wobble-Fix Extension Bars  
32, 50, 75, 125, 150, 250

#### Wobble-Fix Extension Bar

Two way usage

- In a fixed position, as a normal extension bar
- In a half-fixed position, as a flexible extension bar providing a 15° angle operation

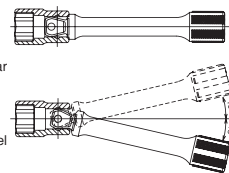

#### Winkel-Verlängerungen

Winkelverlängerungen lassen sich in zwei

Einstellungen verwenden

- voll eingesteckt und starr,
- halb eingesteckt, mit einem Arbeitswinkel von 15°.

#### Rallonges angulaires

Deux utilisations possibles

- comme rallonge normale, dans une position fixe
- comme une rallonge angulaire avec une possibilité d'inclinaison jusqu'à 15°

The Wobble-Fix Extension Bar has less strength than normal extension bar due to it's specific design with a reduced square drive. Make sure to use it correctly.





\* Renewal Kits → 3768RK → P300

**3768J-250** Hinge Handle  
Gelenkgriff  
Poignée articulée



\* Renewal Kits → 3768RK → P300

**3768P-250** Hinge Handle  
Gelenkgriff  
Poignée articulée



\* Renewal Kits → 3768RK → P300

**3768P-380** Hinge Handle ⚠  
Gelenkgriff  
Poignée articulée



	D (mm)	L (mm)	(g)	(pcs.)
3768J-250	20.5	250	248	2
3768P-250	20.5	250	275	5
3768P-380	20.5	380	435	2

⚠ 3768P-380 has longer handle than standard, and can be loaded to excessive torque value. In the interest of your own safety always apply load evenly and progressively to avoid breakage and possible injury.

Der Gelenkgriff 3768-380 ist länger als die Standardversion. Aus Gründen Ihrer Sicherheit, sollten dies Werkzeug nie ruckartig sondern nach und nach belastet werden, um Bruch und damit verbundene, mögliche Verletzungen zu vermeiden.

Du au fait que les manches des 3768-380 sont plus longues que le standard, il y a risque d'une surcharge excessive lors du serrage. Pour éviter casse et blessure, veuillez serrer d'une façon régulière et progressive.

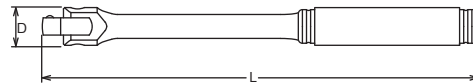

3769N	ℓ (mm)	L (mm)	(g)	(pcs.)
160	50	160	96	2
230	120	230	126	2

**3769N-160/-230** Spin Type Handle ⚠  
Drehgriff  
Poignée emmanchée

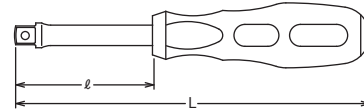

**3769NWF-160/-230** Spin Type Handle Wobble-Fix ⚠  
Drehgriff, Wobble-Fix  
Poignée emmanchée, angulaire

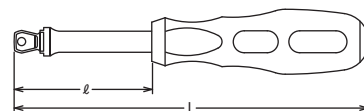

3769NWF	ℓ (mm)	L (mm)	(g)	(pcs.)
160	50	160	96	2
230	120	230	126	2

⚠ Plastic or rubber handles are not intended to act as insulation.

Plastik-oder Gummigriffe stellen keinen Isolierschutz dar.

Les poignées en plastique ou en caoutchouc ne garantissent aucune isolation électrique.



	L (mm)	(g)	(pcs.)
3769H	170	210	2

**3769H** Folding Socket Driver  
Klapp-Drehgriff  
Poignée tournevis articulée

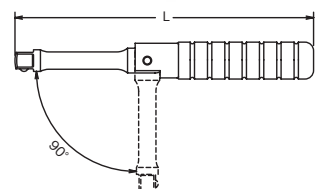

Z-SERIES  
HAND  
TITANIUM  
SCREWDRIVERS ACCESSORIES  
IMPACT  
SLEEVE-DRIVE  
PROTECTOR  
INDUSTRIAL  
AUTOMOTIVE  
MOTORCYCLE  
CONSTRUCTION  
SPARE PART

**3770** Universal Joint  
Gelenk-Einsatz  
Cardan universel

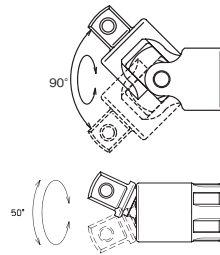

**3771** Universal Joint  
Gelenk-Einsatz  
Joint articlé



	L (mm)	(g)	(pcs.)
<b>3770</b>	50	66	10
<b>3771</b>	43	46	10

**3780** Speed Handle  
Winde  
Vilebrequin

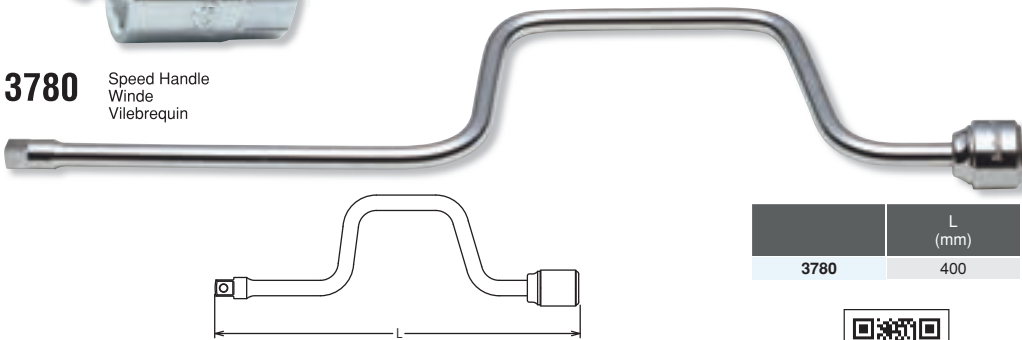

	L (mm)	(g)	(pcs.)
<b>3780</b>	400	432	1

**3785** T-Handle  
T-Griff  
Poignée coulissante

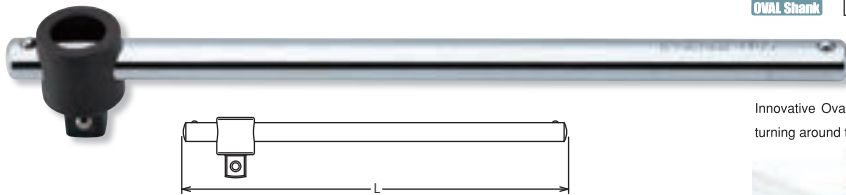

Innovative Oval shaped bar provides higher durability and stops the sliding square part turning around the bar.



**3322A** Adaptor  
Verbindungsstück  
Augmentateur

Warranty 86Nm  
Garantie 86Nm  
Garantie 86Nm



**3344A** Adaptor  
Verbindungsstück  
Augmentateur



	L (mm)	(g)	(pcs.)
<b>3785</b>	200	157	5

	(sq)	(sq)	L (mm)	(g)	(pcs.)
<b>3322A</b>	3/8"	1/4"	24	18	10
<b>3344A</b>	3/8"	1/2"	30	35	10

**⚠** Adapting down from bigger square drive to smaller square drive may lead to excessive torque and possibly cause breakage.

Reduzierstücke sind mit Vernunft einzusetzen. Es besteht Bruchgefahr. Überschreiten Sie niemals die Sicherheitsgrenzen.







Les réducteurs doivent être utilisés avec modération. Ne dépassez jamais la limites de sécurité.

**PK2346/6** Adaptor Set in Plastic Box  
Adaptor Satz in Kunststoffkassette  
Jeu de adaptateur en boîte plastique







- 2233A (11/4") X 3/8"
- 3322A (3/8") X 1/4" Warranty/Garantia 86Nm
- 3344A (3/8") X 1/2"
- 4433A (11/2") X 3/8" Warranty/Garantia 290Nm
- 4466A (11/2") X 3/4"
- 6644A (3/4") X 1/2" Warranty/Garantia 668Nm

PK2346/6		6 Pieces Set / 460g	
PLASTIC TRAY			
Adaptors			
1/4" □ → 3/8" □	2233A	3/8" □ → 1/4" □	3322A
3/8" □ → 1/2" □	3344A	1/2" □ → 3/8" □	4433A-35
1/2" □ → 3/4" □	4466A	3/4" □ → 1/2" □	6644A

<b>ESH3001</b> 17 Pieces Set/△=2,200g	
METAL CASE:W415xH120xT50mm	
Sockets	Accessories
 <b>3410M</b> Surface Drive Sockets 8, 9, 10, 11, 12, 13, 14, 15, 16, 17, 18, 19	 <b>3753J</b>  <b>3760-125</b>  <b>3760-250</b>  <b>3770</b>  <b>3785</b>













**ESH3001** Socket Set  
Steckschlüssel Satz  
Jeu de clés à douille



<b>ETH3001</b> 22 Pieces Set/△=1,820g	
METAL CASE:W392xH90xT50mm	
Sockets	Accessory
 <b>3425 TORX®</b> Sockets E4, E5, E6, E7, E8	 <b>4433A-35</b>
 <b>4425 TORX®</b> Sockets E10, E11, E12, E14, E16, E18	
 <b>3025.50 TORX®</b> Bit Sockets T10, T15, T20, T25, T27	
 <b>4025.60 TORX®</b> Bit Sockets T30, T40, T45, T50, T55	









**ETH3001** Socket Set  
Steckschlüssel Satz  
Jeu de clés à douille



<b>3201AMW</b> 42 Pieces Set/△=4,700g	
METAL CASE:W445xH190xT50mm	
Sockets	Accessories
 <b>3405M</b> 12-pt. Sockets 9, 10, 11, 12, 13, 14, 15, 16, 17, 18, 19, 20, 21, 22	 <b>3753N</b>  <b>3760-75</b>  <b>3760-125</b>  <b>3760-250</b>  <b>3768N-250</b>  <b>3769N-160</b>  <b>3770</b>  <b>3780</b>  <b>3785</b>  <b>3344A</b>
 <b>3405A</b> 12-pt. Sockets 5/16, 3/8, 7/16, 1/2, 9/16, 5/8, 11/16, 3/4, 25/32, 13/16, 7/8	
 <b>3405W</b> 12-pt. Sockets 1/8, 3/16, 1/4, 5/16, 3/8, 7/16, 1/2	









**3201AMW** Socket Set  
Steckschlüssel Satz  
Jeu de clés à douille



<b>3206AM</b> 27 Pieces Set/△=3,500g	
METAL CASE:W445xH190xT50mm	
Sockets	Accessories
 <b>3405M</b> 12-pt. Sockets 7, 8, 10, 11, 12, 13, 14, 15, 16, 17, 19, 22	 <b>3753J</b>  <b>3760-125</b>  <b>3760-250</b>  <b>3768J-250</b>  <b>3770</b>
 <b>3405A</b> 12-pt. Sockets 3/8, 7/16, 1/2, 9/16, 5/8, 11/16, 3/4, 13/16, 7/8	
 <b>3300C</b> Spark Plug Socket 20.8	

**3206AM** Socket Set  
Steckschlüssel Satz  
Jeu de clés à douille









<b>3210M-00</b> 22 Pieces Set/△=2,900g <b>3210M-05</b> 22 Pieces Set/△=2,900g <b>3210M-10</b> 22 Pieces Set/△=2,900g	
METAL CASE:W360xH145xT50mm	
Sockets	Accessories
 (3210M-00) <b>3400M</b> 6-pt. Sockets 6, 7, 8, 9, 10, 11, 12, 13, 14, 15, 16, 17, 18, 19, 21, 22	 <b>3753J</b>  <b>3760-125</b>  <b>3760-250</b>  <b>3768J-250</b>  <b>3770</b>  <b>3785</b>
 (3210M-05) <b>3405M</b> 12-pt. Sockets 6, 7, 8, 9, 10, 11, 12, 13, 14, 15, 16, 17, 18, 19, 21, 22	
 (3210M-10) <b>3410M</b> Surface Drive Sockets 6, 7, 8, 9, 10, 11, 12, 13, 14, 15, 16, 17, 18, 19, 21, 22	

**3210M-00 / 3210A-00** Socket Set  
Steckschlüssel Satz  
Jeu de clés à douille

**3210M-05**  
**3210M-10**



<b>3210A-00</b> 18 Pieces Set/△=2,760g	
METAL CASE:W360xH145xT50mm	
Sockets	Accessories
 <b>3400A</b> 6-pt. Sockets 1/4, 5/16, 11/32, 3/8, 7/16, 1/2, 9/16, 5/8, 11/16, 3/4, 13/16, 7/8	 <b>3753J</b>  <b>3760-125</b>  <b>3760-250</b>  <b>3768J-250</b>  <b>3770</b>  <b>3785</b>

Z-SERIES  
HAND  
TITANIUM  
ACCESSORIES  
SCREWDRIVERS  
IMPACT  
SLEEVE-DRIVE  
PROTECTOR  
INDUSTRIAL  
AUTOMOTIVE  
MOTORCYCLE  
CONSTRUCTION  
SPARE PART

**3216** Spark Plug Sockets Set  
Zündkerzen-Schlüssel Satz  
Jeu de douilles pour bougies



<b>3216</b> 4 Pieces Set/△=730g	
PLASTIC BAG	
Sockets	Accessories
<b>3300C</b> Spark Plug Sockets 16, 20.8	<b>3760-125</b> <b>3774JL</b>

**3217M-00** Socket Set  
Steckschlüssel Satz  
Jeu de clés à douille  
**3217M-05**  
**3217M-10**



<b>3217M-00</b>	14 Pieces Set/△=850g
<b>3217M-05</b>	14 Pieces Set/△=850g
<b>3217M-10</b>	14 Pieces Set/△=850g
METAL CASE:W163xH52xT33mm	
Sockets	
(3217M-00) <b>3400M</b> 6-pt. Sockets 9, 10, 11, 12, 13, 14, 15, 16, 17, 18, 19, 20, 21, 22	
(3217M-05) <b>3405M</b> 12-pt. Sockets 9, 10, 11, 12, 13, 14, 15, 16, 17, 18, 19, 20, 21, 22	
(3217M-10) <b>3410M</b> Surface Drive Sockets 9, 10, 11, 12, 13, 14, 15, 16, 17, 18, 19, 20, 21, 22	

**S3240M-00 / S3240A-00** Display Stands  
**S3240M-05 / S3240A-05** Ausstellungsstände  
Présentoirs



<b>S3240M-00</b>	<b>3400M</b> 177 Pieces Set/△=10,300g	
<b>S3240M-05</b>	<b>3405M</b> 177 Pieces Set/△=10,300g	
DISPLAY STAND:W510xH150xT230mm		
Sockets		
6mm:12pcs	12mm:12pcs	18mm:8pcs
7mm:12pcs	13mm:11pcs	19mm:8pcs
8mm:12pcs	14mm:11pcs	20mm:7pcs
9mm:12pcs	15mm:10pcs	21mm:7pcs
10mm:12pcs	16mm: 9pcs	22mm:7pcs
11mm:12pcs	17mm: 9pcs	23mm:6pcs
<b>S3240A-00</b>	<b>3400A</b> 126 Pieces Set/△=8,500g	
<b>S3240A-05</b>	<b>3405A</b> 126 Pieces Set/△=8,500g	
DISPLAY STAND:W510xH150xT230mm		
Sockets		
1/4" :12pcs	9/16":10pcs	25/32":7pcs
5/16":12pcs	19/32":10pcs	13/16":7pcs
3/8" :12pcs	5/8" : 9pcs	7/8" :7pcs
7/16":12pcs	11/16": 9pcs	
1/2" :11pcs	3/4" : 8pcs	



**3250M-00** Socket Set  
Steckschlüssel Satz  
Jeu de clés à douille  
**3250M-05**



<b>3250M-00</b>	17 Pieces Set/△=2,200g
<b>3250M-05</b>	17 Pieces Set/△=2,200g
METAL CASE:W415xH120xT50mm	
Sockets	Accessories
<b>3400M</b> 6-pt. Sockets 7, 8, 10, 11, 12, 13, 14, 15, 16, 17, 18, 19	<b>3753J</b> <b>3760-125</b> <b>3760-250</b> <b>3770</b> <b>3785</b>
<b>3405M</b> 12-pt. Sockets 7, 8, 10, 11, 12, 13, 14, 15, 16, 17, 18, 19	

**3251** 8 Pieces Set/△=675g

METAL CASE:W160xH100xT28mm

Sockets	Accessories
<b>3025.50 TORX® Bit Sockets</b> T25H, T30H, T40H, T45H, T50H	 <b>2774PS-3/8</b>
	 <b>3763-50</b>
	 <b>3756</b>





**3251**

Bit Socket Set  
Schraubendreher-Steckschlüssel Satz  
Jeu de douilles de vissage

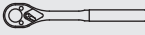

**3252M** 15 Pieces Set/△=1,530g

METAL CASE:W310xH90xT48mm

Sockets	Accessories
<b>3400M 6-pt. Sockets</b> 5.5, 7, 8, 10, 11, 12	 <b>3753P</b>
<b>3405M 12-pt. Sockets</b> 13, 14, 17, 19, 22	 <b>3760-75</b>
	 <b>3760-125</b>
	 <b>3770</b>





**3252M**

Socket Set  
Steckschlüssel Satz  
Jeu de clés à douille

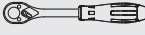

**3275** 24 Pieces Set/△=3,150g

METAL CASE:W400xH147xT50mm

Sockets	Accessories
<b>3400M 6-pt. Sockets</b> 6, 7, 8, 9, 10, 11, 12	 <b>3753J</b>
<b>3405M 12-pt. Sockets</b> 13, 14, 15, 16, 17, 18, 19, 21, 22	 <b>3760-125</b>
<b>3300C Spark Plug Sockets</b> 16, 20.8	 <b>3768J-250</b>
	 <b>3770</b>
	 <b>3756</b>



**3275**

Socket Set  
Steckschlüssel Satz  
Jeu de clés à douille

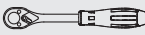

**3277** 29 Pieces Set/△=3,240g

METAL CASE:W370xH150xT50mm

Sockets	Accessories
<b>3400M 6-pt. Sockets</b> 8, 9, 10, 11, 12	 <b>3753J</b>
<b>3405M 12-pt. Sockets</b> 13, 14, 15, 16, 17, 18, 19, 21	 <b>3760-125</b>
<b>3300M 6-pt. Deep Sockets</b> 8, 9, 10, 11, 12	 <b>3768J-250</b>
<b>3305M 12-pt. Deep Sockets</b> 13, 14, 15, 16, 17, 18, 19, 21	



**3277**

Socket Set  
Steckschlüssel Satz  
Jeu de clés à douille



**3278** 20 Pieces Set/△=3,370g

METAL CASE:W310xH150xT50mm

Sockets	Accessories
<b>3000 Bit Sockets</b> 2, 3	 <b>3753J</b>
<b>3010M.62 Hex Bit Sockets</b> 5, 6, 7, 8, 10	 <b>3763-125</b>
<b>3020.50 XZN Bit Sockets</b> M4, M5, M6, M8	
<b>3025.50 TORX® Bit Sockets</b> T10, T15, T20, T25, T27, T30, T40	

**3278**

Bit Socket Set  
Schraubendreher-Steckschlüssel Satz  
Jeu de douilles de vissage



All socket sets can be supplied either with 6-pt. or with 12-pt. opening.  
Alle Steckschlüsselsätze sind mit 6- oder 12-kant Steckschlüsseln erhältlich.  
Tous les coffrets de douilles peuvent être livrés en 6- ou 12-pans.

Z-SERIES  
HAND  
TITANIUM  
SCREWDRIVERS ACCESSORIES  
IMPACT  
SLEEVE-DRIVE  
PROTECTOR  
INDUSTRIAL  
AUTOMOTIVE  
CONSTRUCTION MOTORCYCLE  
SPARE PART

### 4401M 6-point Sockets 6-kant Steckschlüssel Douilles 6-pans

HANDY-ENDY®

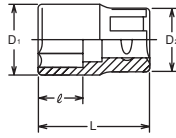

### 4406M 12-point Sockets 12-kant Steckschlüssel Douilles 12-pans

HANDY-ENDY®

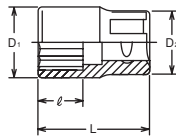

### 4400M 6-point Sockets 6-kant Steckschlüssel Douilles 6-pans

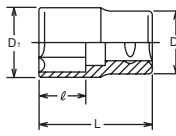

### 4405M 12-point Sockets 12-kant Steckschlüssel Douilles 12-pans

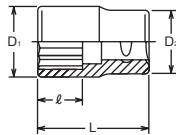

### RS4401M/10 Socket Set on Rail Steckschlüsselsatz auf Schiene Jeu de douilles sur rail



4401M 4406M (mm)	D <sub>1</sub> (mm)	D <sub>2</sub> (mm)	ℓ (mm)	L (mm)	(g)	(pcs.)
8	13.2	22	8	36	44	10
9	13.8	22	8.5	37	44	10
10	15.3	22	9	37	45	10
11	16.5	22	9.5	37	46	10
12	17.8	22	10	37	47	10
13	19	22	10.5	37	53	10
14	20.3	22	11	37	56	10
15	21.5	22	11.5	37	52	10
16	22.8	22	12	37	62	10
17	24	22	12.5	37	69	10
18	25	23	13	37	74	10
19	26.5	24.5	14	38	89	10
20	27.8	26	15	38	92	10
21	29	27	15.5	38	102	10
22	30	28	16	40	113	10
23	31.5	29	16.5	40	128	10
24	32.8	30	17	42	140	5
25	34	31	18	42	164	5
26	35	32	19	42	165	5
27	36.5	33	19.5	43	196	5
28	37.8	34	20	43	198	5
29	39	35	20.5	43	190	5
30	40	36	22	46	222	5
31	41.5	37	22.5	46	257	5
32	42.8	38	23	46	250	5

4400M 4405M (mm)	D <sub>1</sub> (mm)	D <sub>2</sub> (mm)	ℓ (mm)	L (mm)	(g)	(pcs.)
33	44.2	39	24	47	275	5
34	45.2	40	24	47	315	5
35	46.2	40	24	47	317	5
36	47.2	41	24	47	336	5
37	48.3	42	24	47	360	5
38	49.2	43	24	47	380	5
41	53.1	45	29	57	471	5
46	59.1	48	32	60	567	2

### RS4406M/10 Socket Set on Rail Steckschlüsselsatz auf Schiene Jeu de douilles sur rail



RS4401M/10	10 Pieces Set/Rail 300mm	(g)
10, 11, 12, 13, 14, 15, 16, 17, 18, 19		720

RS4406M/10	10 Pieces Set/Rail 300mm	(g)
10, 11, 12, 13, 14, 15, 16, 17, 18, 19		720

# 1/2"

Hand Sockets  
Hand Steckschlüssel  
Douilles à main

	4400A 4405A (inch)	D <sub>1</sub> (mm)	D <sub>2</sub> (mm)	ℓ (mm)	L (mm)	(g)	(pcs.)
New	1/4	10.7	21	6	36	41	10
	5/16	13.2	21	8	36	44	10
	3/8	14.6	21	9	37	45	10
	7/16	16.5	21	9.5	37	46	10
	1/2	19	22	10.5	37	53	10
	9/16	20.3	22	11	37	56	10
	19/32	21.5	22	11.5	37	52	10
	5/8	22.8	22	12	37	62	10
	21/32	24	23	12.5	37	69	10
	11/16	25	24	13	37	74	10
	3/4	26.5	25	14	38	89	10
	25/32	27.8	26	15	38	92	10
	13/16	29	27	15.5	38	102	10
	7/8	30	28	16	40	113	10
	15/16	32.8	30	17	42	140	5
	31/32	34	31	18	42	165	5
	1	35	32	19	42	165	5
	1. 1/16	36.5	33	19.5	43	180	5
	1. 1/8	39	35	20.5	43	210	5
	1. 3/16	40	36	22	46	222	5
	1. 1/4	42.8	38	23	46	250	5
	1. 5/16	44.2	39	24	47	275	5
	1. 3/8	46.2	40	24	47	317	5
	1. 7/16	47.2	41	24	47	336	5
	1. 1/2	49.2	43	24	47	380	5

### Hand Sockets

Both, 6-pt. and 12-pt. openings, are equipped with Flat Drive Openings, transferring the turning power from the corners on the flanks of nuts and bolts.

Sowohl 6-kant als auch 12-kant Steckschlüssel bieten alle Vorteile der "Flat Drive" Öffnung, die die Greifzonen auf die Flächen von Schrauben und Muttern versetzt.

Aussi bien les douilles 6-pans que 12-pans présentent tous les avantages liés au profil FLATDRIVE qui applique la force de serrage aux faces de la vis ou de l'écrou.

### 4400A 6-point Sockets 6-kant Steckschlüssel Douilles 6-pans

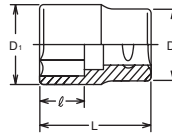

### 4405A 12-point Sockets 12-kant Steckschlüssel Douilles 12-pans

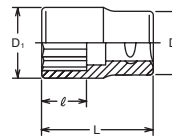











RS4400A/10	10 Pieces Set/Rail 300mm	
3/8, 7/16, 1/2, 9/16, 5/8, 11/16, 3/4, 13/16, 7/8, 15/16		809

RS4405A/10	10 Pieces Set/Rail 300mm	
3/8, 7/16, 1/2, 9/16, 5/8, 11/16, 3/4, 13/16, 7/8, 15/16		809

### RS4400A/10 Socket Set on Rail Steckschlüsselsatz auf Schiene Jeu de douilles sur rail

### RS4405A/10 Socket Set on Rail Steckschlüsselsatz auf Schiene Jeu de douilles sur rail



	 6-Point	 12-Point	 Surface Drive	 Nut Grip®	 TORX® (E)	 TORXPLUS® (EPL)	 Double Square	 LHSTIX® (LH-S)
 1/4"	No. 2400M/A No. 2300M/A No. 2400W-BA No. 2300W-BA No. 2300X series	No. 2405M/A No. 2305M/A No. AS2405A No. AS2305A series	No. 2410M No. 2310M series	No. 2450MS No. 2350M No. 2350X series	No. 2425 No. 2325 series	—	No. 2415M/A series	—
 3/8"	No. 3400M/A No. 3300M/A No. 3400W No. 3300W No. 3300X/XA series	No. 3405M/A No. 3305M/A No. 3405W No. 3305W No. 3350X/XA series	No. 3410M No. 3310M series	No. 3450M No. 3350M No. 3350X series	No. 3425 No. 3325 series	—	No. 3415M/A series	No. 3400LH series
 1/2"	No. 4400M/A No. 4401M No. 4300M/A No. 4400W series	No. 4405M/A No. 4406M No. 4305M/A No. 4405W series	No. 4410M No. 4310M series	No. 4450M series	No. 4425 No. 4325 series	No. 4425-EPL series	—	No. 4400LH series

Z-SERIES  
HAND  
TITANIUM  
SCREWDRIVERS  
ACCESSORIES  
IMPACT  
SLEEVE-DRIVE  
PROTECTOR  
INDUSTRIAL  
AUTOMOTIVE  
MOTORCYCLE  
CONSTRUCTION  
MOTORCYCLE  
SPARE PART

## 4410M

Surface Drive Sockets  
Surface Drive Steckschlüssel  
Douilles, Surface Drive

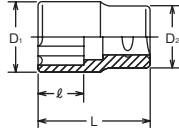

## RS4410M/10

Socket Set on Rail  
Steckschlüsselsatz auf Schiene  
Jeu de douilles sur rail



## SURFACE DRIVE

Surface drive sockets are designed to retain contact with the flat sides of the nut in order to transmit higher torque and reduce nut wear. These sockets are ideal for using on polished nuts, aluminum nuts and nuts with worn out points.

Das Profil unserer Surface-Drive Steckschlüssel greift die Schraube an deren Flächen. Dies sichert eine höhere Kraftübertragung und verhindert ein Durchrutschen des Steckschlüssels. Diese Steckschlüssel eignen sich besonders für polierte Schrauben, Aluminium Schrauben und Schrauben bei denen die Ecken bereits abgerundet sind.

Notre profil Surface Drive assure le contact entre la douille et les plats de l'écrou. Ceci réduit l'usure et permet la transmission d'un couple plus élevé. C'est une solution idéale pour les écrous polies, celles en aluminium ou arrondies.



4410M (mm)	D <sub>1</sub> (mm)	D <sub>2</sub> (mm)	ℓ (mm)	L (mm)	(g)	(pcs.)
8	13.2	21	8	36	44	10
9	13.8	21	8.5	37	44	10
10	15.3	21	9	37	45	10
11	16.5	21	9.5	37	46	10
12	17.8	21	10	37	47	10
13	19	22	10.5	37	53	10
14	20.3	22	11	37	56	10
15	21.5	22	11.5	37	52	10
16	22.8	22	12	37	62	10
17	24	23	12.5	37	69	10
18	25	24	13	37	74	10
19	26.5	25	14	38	89	10
20	27.8	26	15	38	92	10
21	29	27	15.5	38	102	10
22	30	28	16	40	113	10
23	31.5	29	16.5	40	128	10
24	32.8	30	17	42	140	5
25	34	31	18	42	164	5
26	35	32	19	42	165	5
27	36.5	33	19.5	43	196	5
28	37.8	34	20	43	198	5
29	39	35	20.5	43	190	5
30	40	36	22	46	222	5
31	41.5	37	22.5	46	257	5
32	42.8	38	23	46	250	5
34	45.2	40	24	47	314	5

RS4410M/10	10 Pieces Set/Rail 300mm	(g)
10, 11, 12, 13, 14, 15, 17, 19, 21, 22		717

## 4400W

6-point Whitworth Sockets  
6-kant Steckschlüssel, Whitworth  
Douilles à 6-pans Whitworth

## 4405W

12-point Whitworth Sockets  
12-kant Steckschlüssel, Whitworth  
Douilles à 12-pans Whitworth

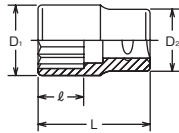

## RS4400W/8

Socket Set on Rail  
Steckschlüsselsatz auf Schiene  
Jeu de douilles sur rail



4400W / 4405W (W)	D <sub>1</sub> (mm)	D <sub>2</sub> (mm)	ℓ (mm)	L (mm)	(g)	(pcs.)
3/16	16.5	21	9.5	37	46	10
1/4	19	22	10.5	37	54	10
5/16	21.5	22	11.5	37	54	10
3/8	25	24	13	37	73	10
7/16	29	27	15.5	38	87	10
1/2	31.5	29	16.5	40	133	10
9/16	35	32	19	42	165	5
5/8	37.8	34	20	43	191	5
11/16	40	36	22	46	222	5
3/4	44.2	39	24	47	280	5

RS4400W/8	8 Pieces Set/Rail 250mm	(g)
3/16, 1/4, 5/16, 3/8, 7/16, 1/2, 9/16, 5/8		860

RS4405W/8	8 Pieces Set/Rail 250mm	(g)
3/16, 1/4, 5/16, 3/8, 7/16, 1/2, 9/16, 5/8		860

## BS W



BS - W	BS	3/16BS	1/4BS	5/16BS	3/8BS	7/16BS	1/2BS	9/16BS	5/8BS	11/16BS	3/4BS	7/8BS
	W	1/8W	3/16W	1/4W	5/16W	3/8W	7/16W	1/2W	9/16W	5/8W	11/16W	3/4W
Across Flat	(ref. mm)	8.6	11.3	13.3	15.2	18.0	20.8	23.4	25.7	27.9	30.5	33.4

## 4425-N

TORX® Sockets  
TORX® Steckschlüssel  
Douilles TORX®

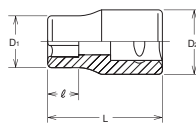

## RS4425/6-N

Socket Set on Rail  
Steckschlüsselsatz auf Schiene  
Jeu de douilles sur rail



4425 (E)	D <sub>1</sub> (mm)	D <sub>2</sub> (mm)	ℓ (mm)	L (mm)	(g)	(pcs.)
E10N	13.2	21	8.2	36	47	10
E12N	14.6	21	9.3	37	48	10
E14N	16.5	21	10.6	37	50	10
E16N	19	22	11.8	37	60	10
E18N	20.3	22	13	37	60	10
E20N	22.8	22	14.4	37	65	10

TORX Socket for Nut and low profile bolt  
Shallow Chamfer on Socket Opening



A : Flywheel bolt MR20 NISSAN: 4425-E20N  
B : Cam sprocket FA20 for TOYOTA/SUBARU: 4425-E16N  
C : Connecting rod bolt FA20 for TOYOTA/SUBARU: 4425-E14N

RS4425/6-N	6 Pieces Set/Rail 200mm	(g)
E10N, E12N, E14N, E16N, E18N, E20N		370



# 1/2"

Hand Sockets  
Hand Steckschlüssel  
Douilles à main

4425 (E)	D <sub>1</sub> (mm)	D <sub>2</sub> (mm)	ℓ (mm)	L (mm)	(g)	(pcs.)
E 8	10.7	21	7	36	41	10
E10	13.2	21	8.2	36	44	10
E11	13.8	21	8.7	37	45	10
E12	14.6	21	9.3	37	47	10
E14	16.5	21	10.6	37	48	10
E16	19	22	11.8	37	57	10
E18	20.3	22	13	37	57	10
E20	22.8	22	14.4	37	63	10
E22	25	24	15.5	37	78	10
E24	26.5	25	17	40	95	5

**4425** TORX® Sockets  
TORX® Steckschlüssel  
Douilles TORX®

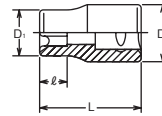

TORX® (E)

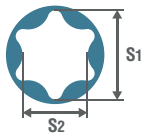

E	E4	E5	E6	E7	E8	E10	E11	E12	E14	E16	E18	E20	E22	E24	E26	E28
S <sub>1</sub> (ref. mm)	3.7	4.6	5.6	6.1	7.4	9.3	9.9	11.0	12.8	14.6	16.5	18.3	20.1	22.0	23.7	25.5
S <sub>2</sub> (ref. mm)	2.7	3.3	4.0	4.3	5.3	6.8	7.1	7.9	9.2	10.5	11.9	13.2	14.8	15.7	17.5	18.3

RS4425/7	7 Pieces Set/Rail 200mm	(g)
E10, E12, E14, E16, E18, E20, E24		428

**RS4425/7** Socket Set on Rail  
Steckschlüsselsatz auf Schiene  
Jeu de douilles sur rail



4425 (EPL)	D <sub>1</sub> (mm)	D <sub>2</sub> (mm)	ℓ (mm)	L (mm)	(g)	(pcs.)
10EPL	13.2	21	6.2	36	45	10
12EPL	14.6	21	7.2	37	47	10
14EPL	16.5	21	8.1	37	49	10
16EPL	19	22	9.2	37	60	10
18EPL	20.3	22	10.2	37	60	10
20EPL	22.9	22	11.2	37	65	10

**4425 (EPL)** TORXPLUS® Sockets  
TORXPLUS® Steckschlüssel  
Douilles TORXPLUS®

**TORXplus®**

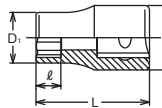

RS4425/6-EPL	6 Pieces Set/Rail 200mm	(g)
10EPL, 12EPL, 14EPL, 16EPL, 18EPL, 20EPL		390

**RS4425/6-EPL** Socket Set on Rail  
Steckschlüsselsatz auf Schiene  
Jeu de douilles sur rail



# TORXplus®

TORX PLUS  
EP/EPL-style



TORX  
E-style



### Straight Sidewalls & Reduced Recess Fall Away

- Increase tool engagement
- Virtually eliminates camout
- Ensures proper torque transfer
- Greatly reduces end load requirements
- Can reduce worker fatigue and muscular stress during manual assembly

### Elliptically-based Geometry and Lobe Engagement

- Broadens contact surface to maximize engagement of driver and recess
- Eliminates damaging point-to-point contact

### 0° Drive Angle

- Optimises torque transmission
- Virtually eliminates radial stresses to increase tool bit life
- Enables use of recesses with thinner walls

### Six Lobes with Large Cross-Sectional Areas

- Enables faster tool engagement
- Maximizes torque transfer
- Increases torsional strength

TORX is a registered trademark of Acument Intellectual Properties, LLC.  
TORX ist ein registriertes Markenzeichen der Firma Acument Intellectual Properties, LLC.  
TORX est une marque déposée de Acument Intellectual Properties, LLC.

TORXplus is a registered trademark of Acument Intellectual Properties, LLC.  
TORXplus ist ein registriertes Markenzeichen der Firma Acument Intellectual Properties, LLC.  
TORXplus est une marque déposée de Acument Intellectual Properties, LLC.

# Hand Sockets Hand Steckschlüssel Douilles à main

# 1/2"

Z-SERIES  
HAND  
TITANIUM  
ACCESSORIES  
SCREWDRIVERS  
IMPACT  
SLEEVE-DRIVE  
PROTECTOR  
INDUSTRIAL  
AUTOMOTIVE  
MOTORCYCLE  
CONSTRUCTION  
SPARE PART

## 4400LH

 LHSTIX® Sockets  
Steckschlüssel mit LHSTIX® Profil  
Douilles au profil LHSTIX®

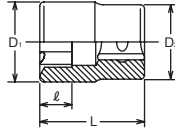

4400LH (LH-S)	D <sub>1</sub> (mm)	D <sub>2</sub> (mm)	ℓ (mm)	L (mm)	(g)	(pcs.)
6S	13.2	21	5.6	36	44	10
8S	16.5	21	6.8	37	46	10
10S	19	22	8	37	53	10
12S	22.8	22	9.2	37	62	10
14S	25	24	10.4	37	74	10
16S	29	27	11.6	38	102	10

### LHSTIX®

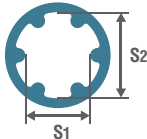

LH-S	LH-5S	LH-6S	LH-8S	LH-10S	LH-12S	LH-14S	LH-16S
S <sub>1</sub> (ref. mm)	5.6	6.8	9.0	11.3	13.6	15.8	18.1
S <sub>2</sub> (ref. mm)	7.5	9.0	12.0	15.0	18.0	21.0	24.0

## RS4400LH/6

  Socket Set on Rail  
Steckschlüsselsatz auf Schiene  
Jeu de douilles sur rail



RS4400LH/6	6 Pieces Set/Rail 200mm	(g)
6S, 8S, 10S, 12S, 14S, 16S		430

## 4450M

 Nut Grip® Sockets  
Steckschlüssel mit 2-facher Kugelhalterung  
Douilles à billes de retenue

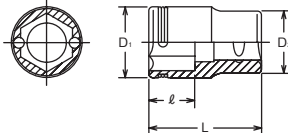

## NUT GRIP®

Twin balls at the 6-point opening hold bolt/nut tightly for safe and reliable work.

Die zwei Kugeln in der 6-kant Öffnung unserer NUT GRIP Steckschlüssel halten die Schraube sicher im Steckschlüssel. Dies erlaubt ein Arbeiten auch an schwer zugänglichen Stellen.

Les 2 billes dans l'ouverture du 6-pans de la douille retiennent l'écrou de manière sûre et efficace.

4450M (mm)	D <sub>1</sub> (mm)	D <sub>2</sub> (mm)	ℓ (mm)	L (mm)	(g)	(pcs.)
10	15.3	21	6	36	44	10
11	16.5	21	6.5	36	46	10
12	17.8	21	7	36	46	10
13	19	22	8	36	52	10
14	20.3	22	8.5	36	54	10
15	21.5	22	9	36	52	10
16	22.8	22	9	36	60	10
17	24	23	9.5	36	68	10
18	25	24	10.5	36	77	10
19	26.5	25	11.5	36	85	10
21	29	27	12	37	110	10
22	30	28	12.5	37	105	10
24	32.8	30	14.5	39	130	5
27	36.5	33	16.5	40	139	5

## RS4450M/10

  Socket Set on Rail  
Steckschlüsselsatz auf Schiene  
Jeu de douilles sur rail



RS4450M/10	10 Pieces Set/Rail 300mm	(g)
10, 11, 12, 13, 14, 15, 17, 19, 21, 22		717

### 4300M / 4300A

6-point Deep Sockets  
6-kant Steckschlüssel, lang  
Douilles longues, 6-pans

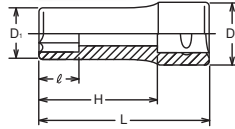

4300M 4305M (mm)	D <sub>1</sub> (mm)	D <sub>2</sub> (mm)	ℓ (mm)	H (mm)	L (mm)	(g)	(pcs.)
8	13.2	21	9	59	77	76	10
9	13.8	21	10	59	77	82	10
10	15.3	21	11	59	77	82	10
11	16.5	21	12	59	77	86	10
12	17.8	21	13	59	77	92	10
13	19	21.8	14	59	77	106	10
14	20.3	21.8	15	59	77	115	10
15	21.5	21.8	16	59	77	123	10
16	22.8	22	17	59	77	141	10
17	24	23	18	59	77	139	10
18	25	24	19	59	77	149	10
19	26.5	25	20	58	77	165	10
20	27.8	26	21	58	77	183	10
21	29	27	23	58	77	190	10
22	30	28	27	57	77	200	10
23	31.5	29	27	57	77	233	10
24	32.8	30	27	57	77	249	10
25	34	31	27	57	77	270	10
26	35	32	27	56	77	279	10
27	36.5	33	28	56	77	303	10
28	37.8	34	28	56	77	331	10
29	39	35	28	55	77	357	10
30	40	36	34	55	77	342	10
31	41.5	37	34	55	77	384	10
32	42.8	38	34	55	77	405	10
33	44.2	39	35	54	77	420	5
34	45.2	40	35	54	77	442	5
35	46.2	40	35	53	77	458	5
36	47.2	41	35	53	77	484	5
37	48.2	42	38	53	77	475	5
38	49	44	38	53	77	490	5

### 4305M / 4305A

12-point Deep Sockets  
12-kant Steckschlüssel, lang  
Douilles longues, 12-pans

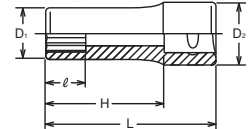

4300A 4305A (inch)	D <sub>1</sub> (mm)	D <sub>2</sub> (mm)	ℓ (mm)	H (mm)	L (mm)	(g)	(pcs.)
5/16	13.2	21	9	59	77	76	10
3/8	14.6	21	10	59	77	82	10
7/16	16.5	21	12	59	77	86	10
1/2	19	21.8	14	59	77	106	10
9/16	20.3	21.8	15	59	77	115	10
19/32	21.5	21.8	16	59	77	123	10
5/8	22.8	22	17	59	77	141	10
21/32	24	23	18	59	77	139	10
11/16	25	24	19	59	77	149	10
3/4	26.5	25	20	58	77	165	10
25/32	27.8	26	21	58	77	183	10
13/16	29	27	23	58	77	190	10
7/8	30	28	27	57	77	200	10
15/16	32.8	30	27	57	77	249	10
31/32	34	31	27	57	77	270	10
1	35	32	27	56	77	279	10
1. 1/16	36.5	33	28	56	77	303	10
1. 1/8	37.8	34	28	56	77	331	10
1. 3/16	40	36	34	55	77	342	10
1. 1/4	42.8	38	34	55	77	405	10
1. 5/16	44.2	39	35	54	77	420	5
1. 3/8	46.2	40	35	54	77	422	5
1. 7/16	47.2	41	35	53	77	484	5
1. 1/2	49	44	38	53	77	523	5
1.13/16	59	48	38	51	77	791	5

New

RS4300M/10	10 Pieces Set/Rail 300mm	(g)
10, 11, 12, 13, 14, 15, 17, 19, 21, 22		1,415

RS4305M/10	10 Pieces Set/Rail 300mm	(g)
10, 11, 12, 13, 14, 15, 17, 19, 21, 22		1,415

RS4300M /12	12 Pieces Set/Rail 300mm	(g)
10, 12, 13, 14, 15, 16, 17, 18, 19, 20, 21, 22		1,825

RS4300A/10	10 Pieces Set/Rail 300mm	(g)
3/8, 7/16, 1/2, 9/16, 5/8, 11/16, 3/4, 13/16, 7/8, 15/16		1,600

RS4305A/10	10 Pieces Set/Rail 300mm	(g)
3/8, 7/16, 1/2, 9/16, 5/8, 11/16, 3/4, 13/16, 7/8, 15/16		1,600

### RS4300M/10

Socket Set on Rail  
Steckschlüsselsatz auf Schiene  
Jeu de douilles sur rail

### RS4305M/10



### RS4300M/12

Socket Set on Rail  
Steckschlüsselsatz auf Schiene  
Jeu de douilles sur rail



### RS4300A/10

Socket Set on Rail  
Steckschlüsselsatz auf Schiene  
Jeu de douilles sur rail

### RS4305A/10



# Hand Sockets Hand Steckschlüssel Douilles à main

## 1/2"

Z-SERIES  
HAND  
TITANIUM  
SCREWDRIVERS ACCESSORIES  
IMPACT  
SLEEVE-DRIVE  
PROTECTOR  
INDUSTRIAL  
AUTOMOTIVE  
MOTORCYCLE  
CONSTRUCTION  
SPARE PART

### 4310M Surface Drive Deep Sockets Surface Drive Steckschlüssel, lang Douilles longues, Surface Drive

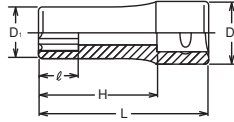
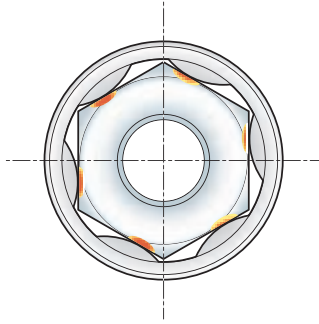

4310M (mm)	D <sub>1</sub> (mm)	D <sub>2</sub> (mm)	ℓ (mm)	H (mm)	L (mm)	(g)	(pcs.)
8	13.2	21	9	59	77	79	10
9	13.8	21	10	59	77	82	10
10	15.3	21	11	59	77	82	10
11	16.5	21	12	59	77	86	10
12	17.8	21	13	59	77	92	10
13	19	21.8	14	59	77	106	10
14	20.3	21.8	15	59	77	115	10
15	21.5	21.8	16	59	77	123	10
16	22.8	22	17	59	77	141	10
17	24	23	18	59	77	139	10
18	25	24	19	59	77	149	10
19	26.5	25	20	58	77	165	10
20	27.8	26	21	58	77	183	10
21	29	27	23	58	77	190	10
22	30	28	27	57	77	200	10
23	31.5	29	27	57	77	233	10
24	32.8	30	27	57	77	249	10
25	34	31	27	57	77	270	10
26	35	32	27	56	77	279	10
27	36.5	33	28	56	77	303	10
28	37.8	34	28	56	77	334	10
29	39	35	28	55	77	357	10
30	40	36	34	55	77	342	10
31	41.5	37	34	55	77	384	10
32	42.8	38	34	55	77	405	10
34	45.2	40	35	54	77	442	5

### RS4310M/10 Socket Set on Rail Steckschlüsselsatz auf Schiene Jeu de douilles sur rail



RS4310M/10	10 Pieces Set/Rail 300mm	(g)
10, 11, 12, 13, 14, 15, 17, 19, 21, 22		1,415

### 4325 TORX® Deep Sockets TORX® Steckschlüssel, lang Douilles longues TORX®

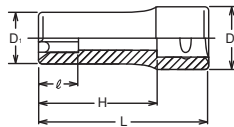

4325 (E)	D <sub>1</sub> (mm)	D <sub>2</sub> (mm)	ℓ (mm)	H (mm)	L (mm)	(g)	(pcs.)
E 8	10.7	21	7	59	77	68	10
E10	13.2	21	8.2	59	77	99	10
E11	13.8	21	8.7	59	77	84	10
E12	14.6	21	9.3	59	77	99	10
E14	16.5	21	10.6	59	77	103	10
E16	19	21.8	11.8	59	77	107	10
E18	20.3	21.8	13	59	77	118	10
E20	22.8	22	14.4	59	77	141	10
<b>E22</b>	25	24	15.5	59	77	188	10
E24	26.6	25	17	59	77	215	10

### RS4325/7 Socket Set on Rail Steckschlüsselsatz auf Schiene Jeu de douilles sur rail



RS4325/7	7 Pieces Set/Rail 200mm	(g)
E10, E12, E14, E16, E18, E20, E24		900

4300M(L120) (mm)	D <sub>1</sub> (mm)	D <sub>2</sub> (mm)	ℓ (mm)	H (mm)	L (mm)	(g)	(pcs.)
8	13.2	21	9	102	120	120	5
10	15.3	21	11	102	120	138	5
12	17.8	21	13	102	120	157	5
14	20.3	21.8	15	102	120	193	5
16	22.8	22	17	102	120	210	5

## 4300M (L120) 6-point Extra Deep Sockets 6-kant Steckschlüssel, extra lang Douilles extra longues 6-pans

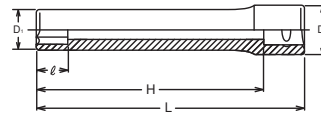

4325(L140)	D <sub>1</sub> (mm)	D <sub>2</sub> (mm)	ℓ (mm)	H (mm)	L (mm)	(g)	(pcs.)
E 8	10.7	21	7	122	140	110	5
E10	13.2	21	8.2	122	140	140	5
E12	14.6	21	9.3	122	140	160	5
E14	16.5	21	10.6	122	140	180	5

## 4325 (L140) TORX® Extra Deep Sockets TORX® Steckschlüssel, extra lang Douilles extra longues TORX®

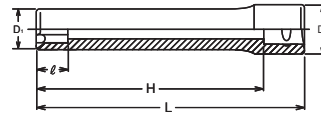

4325(L140) (2B)	D <sub>1</sub> (mm)	D <sub>2</sub> (mm)	ℓ (mm)	H (mm)	L (mm)	(g)	(pcs.)
E 8(2B)	10.7	21	6.6	122	140	110	5
E10(2B)	13.2	21	7.4	122	140	140	5
E12(2B)	14.6	21	9	122	140	160	5
E14(2B)	16.5	21	9.8	122	140	180	5

For Cylinder head bolt

## 4325 (L140)-2B TORX® Sockets Nut Grip® TORX Steckschlüssel mit 2-facher Kugelhalterung Douilles Torx à deux billes de retenue

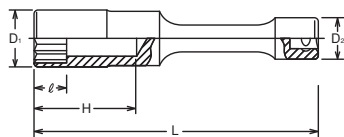
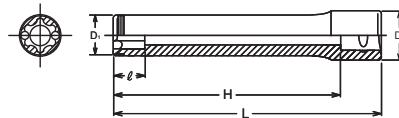

## 4117M-125/-250 Extended Sockets Schaftsteckschlüssel Douilles rallongées



4117M-125 (mm)	D <sub>1</sub> (mm)	D <sub>2</sub> (mm)	ℓ (mm)	H (mm)	L (mm)	(g)	(pce.)
13	18.7	24	13	59	125	213	1
14	20.2	24	14	59	125	227	1
17	24	24	17	59	125	274	1
19	26.9	24	19	59	125	279	1
21	28.5	24	21	59	125	291	1
22	30	24	22	59	125	323	1
24	32	24	24	59	125	361	1
27	36.5	24	27	59	125	439	1
30	40	24	30	59	125	461	1
32	42	24	32	59	125	498	1

4117M-250 (mm)	D <sub>1</sub> (mm)	D <sub>2</sub> (mm)	ℓ (mm)	H (mm)	L (mm)	(g)	(pce.)
13	18.7	24	13	59	250	412	1
14	20.2	24	14	59	250	423	1
17	24	24	17	59	250	469	1
19	26.9	24	19	59	250	484	1
21	28.5	24	21	59	250	496	1
22	30	24	22	59	250	516	1
24	32	24	24	59	250	560	1
27	36.5	24	27	59	250	641	1
30	40	24	30	59	250	663	1
32	42	24	32	59	250	698	1

# Hand Sockets Hand Steckschlüssel Douilles à main

## 1/2"

Z-SERIES  
HAND  
TITANIUM  
SCREWDRIVERS  
ACCESSORIES  
IMPACT  
SLEEVE-DRIVE  
PROTECTOR  
INDUSTRIAL  
AUTOMOTIVE  
MOTORCYCLE  
CONSTRUCTION  
SPARE PART

### 4440M / 4440A 6-point Universal Sockets 6-kant Gelenk-Einsätze Douilles articulées, 6-pans

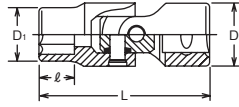

4440M (mm)	D <sub>1</sub> (mm)	D <sub>2</sub> (mm)	ℓ (mm)	L (mm)	(g)	(pcs.)
9	14	25	8.3	63	150	10
10	15.3	25	8.8	63	155	10
11	16.5	25	10	65	158	10
12	17.8	25	10.5	65	151	10
13	19	25	11.4	66	152	10
14	20.3	25	11.4	66	151	10
15	21.5	25	13	68	149	10
16	22.8	25	13	68	150	10
17	24	25	14	69	150	10
18	25.3	25	14	69	150	10
19	26.5	25	15	71	170	10
20	27.8	25	15	71	173	5
21	29	25	16	72	176	5
22	30.3	25	16	72	185	5

4440A (inch)	D <sub>1</sub> (mm)	D <sub>2</sub> (mm)	ℓ (mm)	L (mm)	(g)	(pcs.)
3/8	14.8	25	8.8	63	155	10
7/16	16.5	25	10	65	158	10
1/2	19	25	11.4	66	152	10
9/16	20.3	25	11.4	66	151	10
5/8	22.8	25	13	68	150	10
11/16	24.6	25	14	69	153	10
3/4	26.5	25	15	71	170	10
7/8	30.3	25	16	72	185	5

### 4440T TORX® Universal Sockets TORX® Gelenk-Einsätze Douilles articulées, TORX®

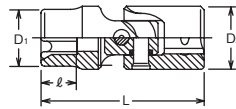

4440T (E)	D <sub>1</sub> (mm)	D <sub>2</sub> (mm)	ℓ (mm)	L (mm)	(g)	(pcs.)
E10	13.2	25	8.2	62	145	10
E12	15	25	9.3	63	147	10
E14	16.3	25	10.6	65	148	10
E16	18.8	25	11.8	65	150	10
E18	20.4	25	13	67	153	10

### 4000-60 (PH) Phillips Bit Sockets Steckschlüssel für Kreuzschlitzschrauben, Phillips Douilles tournevis pour vis à empreinte Phillips

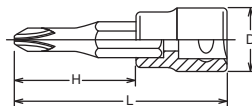

4000 (PH)	D (mm)	H (mm)	L (mm)	(g)	(pcs.)
2	22	23.5	60	65	10
3	22	23.5	60	65	10
4	22	23.5	60	67	10

### 4000-60 (PZ) PZ Bit Sockets Steckschlüssel für Kreuzschlitzschrauben, PZ Douilles tournevis pour vis à empreinte PZ

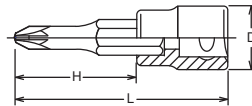

4000-60 (PZ)	D (mm)	H (mm)	L (mm)	(g)	(pcs.)
PZ2	22	23.5	60	65	10
PZ3	22	23.5	60	65	10

### 4005-60 Bit Sockets for Slotted Heads Steckschlüssel für Schlitzschrauben Douilles tournevis pour vis à fente

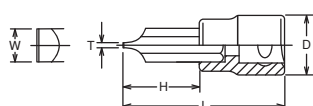

4005	T×W (mm)	D (mm)	H (mm)	L (mm)	(g)	(pcs.)
8	1.2× 8	22	23.5	60	65	10
10	1.6×10	22	23.5	60	75	10
12	2.0×12	23	23.5	60	111	10
14	2.5×14	24	23.5	60	133	10
16	2.5×16	24	23.5	60	133	10

# 1/2"

Hand Sockets  
Hand Steckschlüssel  
Douilles à main

## 4010M-50/-75/-100/-160 4010A-60



Inhex Bit Sockets  
Steckschlüssel für Innensechskant-Schrauben  
Douilles tournevis pour vis 6-pans creux



4010M-50 (mm)	D (mm)	H (mm)	L (mm)	(g)	(pcs.)
4	22	13.5	50	61	10
5	22	13.5	50	62	10
6	22	13.5	50	64	10
7	22	13.5	50	65	10
8	22	13.5	50	66	10
New 9	22	13.5	50	73	10
10	22	13.5	50	75	10
12	23	13.5	50	105	10
13	24	13.5	50	120	10
14	24	13.5	50	120	10
16	25	15	50	150	10
17	25	15	50	150	10
18	27	15	50	200	5
19	27	15	50	200	5

4010M-75 (mm)	D (mm)	H (mm)	L (mm)	(g)	(pcs.)
4	22	38.5	75	69	10
5	22	38.5	75	70	10
6	22	38.5	75	72	10
7	22	38.5	75	73	10
8	22	38.5	75	74	10
New 9	22	38.5	75	90	10
10	22	38.5	75	92	10
12	23	38.5	75	130	10
13	24	38.5	75	150	10
14	24	38.5	75	150	10
16	25	35	75	180	10
17	25	35	75	180	10
18	27	33	75	230	5
19	27	33	75	230	5

4010M-100 (mm)	D (mm)	H (mm)	L (mm)	(g)	(pcs.)
4	22	63.5	100	77	10
5	22	63.5	100	78	10
6	22	63.5	100	80	10
7	22	63.5	100	82	10
8	22	63.5	100	84	10
New 9	22	63.5	100	105	10
10	22	63.5	100	109	10
12	23	63.5	100	155	10
13	24	63.5	100	180	5
14	24	63.5	100	180	5
16	25	60	100	250	5
17	25	60	100	250	5
18	27	58	100	300	5
19	27	58	100	300	5

4010M-160 (mm)	D (mm)	H (mm)	L (mm)	(g)	(pcs.)
4	22	123.5	160	103	10
5	22	123.5	160	104	10
6	22	123.5	160	106	10
7	22	123.5	160	108	10
8	22	123.5	160	110	10
10	22	123.5	160	126	10
12	23	123.5	160	180	5
14	24	123.5	160	260	5
17	25	120	160	360	5
19	27	118	160	415	5

4010A-60 (inch)	D (mm)	H (mm)	L (mm)	(g)	(pcs.)
5/32	22	23.5	60	57	10
3/16	22	23.5	60	57	10
7/32	22	23.5	60	59	10
1/4	22	23.5	60	63	10
9/32	22	23.5	60	65	10
5/16	22	23.5	60	67	10
11/32	22	23.5	60	75	10
3/8	22	23.5	60	76	10
7/16	23	23.5	60	101	10
1/2	24	23.5	60	124	10
9/16	25	20	60	127	10
5/8	25	20	60	174	10
3/4	27	18	60	220	5



RS4010M/10-L50	10 Pieces Set/Rail 300mm	(g)
4, 5, 6, 7, 8, 10, 12, 14, 17, 19	968	
RS4010M/10-L75	10 Pieces Set/Rail 300mm	(g)
4, 5, 6, 7, 8, 10, 12, 14, 17, 19	1,207	
RS4010A/10-L60	10 Pieces Set/Rail 300mm	(g)
3/16, 7/32, 1/4, 5/16, 3/8, 7/16, 1/2, 9/16, 5/8, 3/4	1,080	

## RS4010M/10-L50 RS4010M/10-L75 RS4010A/10-L60



Socket Set on Rail  
Steckschlüsselsatz auf Schiene  
Jeu de douilles sur rail



# Hand Sockets Hand Steckschlüssel 1/2" Douilles à main

Z-SERIES  
HAND  
TITANIUM  
SCREWDRIVERS ACCESSORIES  
IMPACT  
SLEEVE-DRIVE  
PROTECTOR  
INDUSTRIAL  
AUTOMOTIVE  
MOTORCYCLE  
CONSTRUCTION  
SPARE PART

## 4012M-43/-60/-75/-100



Inhex Sockets  
Steckschlüssel für Innensechskant-Schrauben  
Douilles tournevis pour vis 6-pans creux

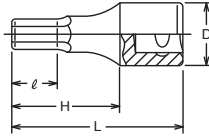

4012M-43 (mm)	D (mm)	ℓ (mm)	H (mm)	L (mm)	(g)	(pcs.)
4	21.1	11.5	23	43	40	10
5	21.1	11.5	23	43	46	10
6	21.1	11.5	23	43	42	10
7	21.1	11.5	23	43	46	10
8	21.1	11.5	23	43	49	10
9	21.1	11.5	23	43	63	10
10	23	11.5	23	43	63	10
11	25	11.5	23	43	74	10
12	25	11.5	23	43	81	10
13	25	11.5	23	43	85	10
14	25	11.5	23	43	88	10
15	26	11.5	23	43	91	10
16	26	11.5	23	43	100	10
17	26	11.5	23	43	101	10
18	26	11.5	23	43	106	10
19	26	11.5	23	43	110	10
20	26	11.5	23	43	130	10
21	26	11.5	23	43	140	10
22	26	11.5	23	43	145	10
23	28	11.5	23	43	167	10
24	28	11.5	23	43	170	10
27	32	11.5	23	43	226	10

4012M-60 (mm)	D (mm)	ℓ (mm)	H (mm)	L (mm)	(g)	(pcs.)
4	21.1	15.5	38	60	49	10
5	21.1	15.5	38	60	55	10
6	21.1	15.5	38	60	56	10
7	21.1	15.5	38	60	60	10
8	21.1	15.5	38	60	64	10
9	21.1	15.5	38	60	78	10
10	23	15.5	38	60	78	10
11	25	15.5	38	60	100	10
12	25	15.5	38	60	107	10
13	25	15.5	38	60	111	10
14	25	15.5	38	60	122	10
15	26	15.5	38	60	125	10
16	26	15.5	38	60	134	10
17	26	15.5	38	60	141	10
18	26	15.5	38	60	153	10
19	26	15.5	38	60	159	10
21	26	15.5	38	60	197	10
22	26	22.5	38	60	205	10
23	28	22.5	38	60	242	10
24	28	22.5	38	60	245	10

4012M-75 (mm)	D (mm)	ℓ (mm)	H (mm)	L (mm)	(g)	(pcs.)
4	21.1	15.5	53	75	52	10
5	21.1	15.5	53	75	58	10
6	21.1	15.5	53	75	62	10
7	21.1	15.5	53	75	70	10
8	21.1	15.5	53	75	74	10
9	21.1	15.5	53	75	88	10
10	23	15.5	53	75	94	10
11	25	15.5	53	75	119	10
12	25	15.5	53	75	122	10
13	25	15.5	53	75	137	10
14	25	15.5	53	75	148	10
15	26	15.5	53	75	151	10
16	26	15.5	53	75	171	10
17	26	15.5	53	75	184	10
18	26	15.5	53	75	196	10
19	26	15.5	53	75	212	10
New 22	26	22.5	53	75	266	10
New 24	27.9	22.5	53	75	315	10

4012M-100 (mm)	D (mm)	ℓ (mm)	H (mm)	L (mm)	(g)	(pcs.)
4	24	15.5	78	100	75	10
5	24	15.5	78	100	81	10
6	24	15.5	78	100	85	10
7	24	15.5	78	100	93	10
8	24	15.5	78	100	97	10
9	24	15.5	78	100	111	10
10	24	15.5	78	100	117	10
11	24	15.5	78	100	142	10
12	24	15.5	78	100	143	10
13	24	15.5	78	100	158	10
14	24	15.5	78	100	169	10
15	24	15.5	78	100	172	10
16	24	15.5	78	100	192	5
17	24	15.5	78	100	215	5
18	24	15.5	78	100	227	5
19	24	15.5	78	100	243	5

## RS4012M/10-L60



Socket Set on Rail  
Steckschlüsselsatz auf Schiene  
Jeu de douilles sur rail





RS4012M/10-L60	10 Pieces set/Rail 300mm	(g)
4, 5, 6, 7, 8, 10, 12, 14, 17, 19		910



4012M/A are for hand use only.  
Do not use with a power or impact wrench.  
Nicht auf Maschinenschrauben verwenden.  
À ne pas utiliser sur des machines



## 4012A-43/-60/-75/-100

 Inhex Sockets  
Steckschlüssel für Innensechskant-Schrauben   
Douilles tournevis pour vis 6-pans creux

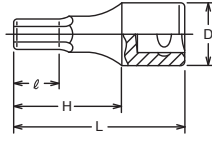

4012A-43 (inch)	D (mm)	ℓ (mm)	H (mm)	L (mm)	(g)	(pcs.)
5/32	21.1	11.5	23	43	40	10
3/16	21.1	11.5	23	43	46	10
7/32	21.1	11.5	23	43	42	10
1/4	21.1	11.5	23	43	43	10
9/32	21.1	11.5	23	43	46	10
5/16	21.1	11.5	23	43	49	10
11/32	21.1	11.5	23	43	63	10
3/8	23	11.5	23	43	59	10
7/16	25	11.5	23	43	74	10
1/2	25	11.5	23	43	85	10
9/16	25	11.5	23	43	88	10
5/8	26	11.5	23	43	100	10
3/4	26	11.5	23	43	110	10
<b>New</b> 7/8	26	11.5	23	43	141	10

4012A-60 (inch)	D (mm)	ℓ (mm)	H (mm)	L (mm)	(g)	(pcs.)
5/32	21.1	15.5	38	60	49	10
3/16	21.1	15.5	38	60	55	10
7/32	21.1	15.5	38	60	56	10
1/4	21.1	15.5	38	60	57	10
9/32	21.1	15.5	38	60	60	10
5/16	21.1	15.5	38	60	64	10
11/32	21.1	15.5	38	60	78	10
3/8	23	15.5	38	60	74	10
7/16	25	15.5	38	60	100	10
1/2	25	15.5	38	60	111	10
9/16	25	15.5	38	60	122	10
5/8	26	15.5	38	60	134	10
3/4	26	15.5	38	60	159	10
<b>New</b> 7/8	26	22.5	38	60	202	10

4012A-75 (inch)	D (mm)	ℓ (mm)	H (mm)	L (mm)	(g)	(pcs.)
5/32	21.1	15.5	53	75	52	10
3/16	21.1	15.5	53	75	58	10
7/32	21.1	15.5	53	75	62	10
1/4	21.1	15.5	53	75	65	10
9/32	21.1	15.5	53	75	70	10
5/16	21.1	15.5	53	75	74	10
11/32	21.1	15.5	53	75	88	10
3/8	23	15.5	53	75	86	10
7/16	25	15.5	53	75	119	10
1/2	25	15.5	53	75	137	10
9/16	25	15.5	53	75	148	10
5/8	26	15.5	53	75	171	10
3/4	26	15.5	53	75	212	10
<b>New</b> 7/8	26	22.5	53	75	262	10

4012A-100 (inch)	D (mm)	ℓ (mm)	H (mm)	L (mm)	(g)	(pcs.)
5/32	24	15.5	78	100	75	10
3/16	24	15.5	78	100	81	10
7/32	24	15.5	78	100	85	10
1/4	24	15.5	78	100	88	10
9/32	24	15.5	78	100	93	10
5/16	24	15.5	78	100	97	10
11/32	24	15.5	78	100	111	10
3/8	24	15.5	78	100	109	10
7/16	24	15.5	78	100	142	10
1/2	24	15.5	78	100	158	10
9/16	24	15.5	78	100	169	10
5/8	24	15.5	78	100	192	5
3/4	24	15.5	78	100	243	5

RS4012A/10-L60	10 Pieces set/Rail 300mm	(g)
3/16, 7/32, 1/4, 5/16, 3/8, 7/16, 1/2, 9/16, 5/8, 3/4		950

## RS4012A/10-L60



Socket Set on Rail  
Steckschlüsselsatz auf Schiene  
Jeu de douilles sur rail



 4012M/A are for hand use only.  
Do not use with a power or impact wrench.  
Nicht auf Maschinenschrauben verwenden.  
À ne pas utiliser sur des machines

Hand Sockets  
Hand Steckschlüssel  
Douilles à main

# 1/2"

Z-SERIES  
HAND  
TITANIUM  
SCREWDRIVERS ACCESSORIES  
IMPACT  
SLEEVE-DRIVE  
PROTECTOR  
INDUSTRIAL  
AUTOMOTIVE  
MOTORCYCLE  
CONSTRUCTION  
SPARE PART

## 4020-60/-100/-120/-140

 XZN Bit Sockets  
Steckschlüssel für XZN Schrauben  
Douilles tournevis pour empreinte XZN

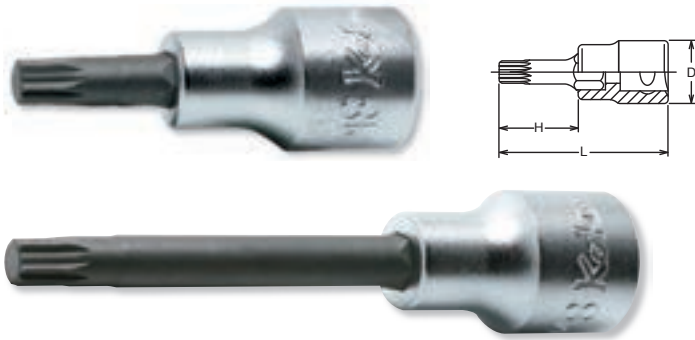

4020-60 (XZN)	D (mm)	H (mm)	L (mm)	(g)	(pcs.)
M 5	22	23.5	60	60	10
M 6	22	23.5	60	61	10
M 8	22	23.5	60	63	10
M10	23	23.5	60	93	10
M12	23	23.5	60	97	10
M14	24	23.5	60	105	10
M16	25	20	60	165	10
M18	27	20	60	215	5

4020-100 (XZN)	D (mm)	H (mm)	L (mm)	(g)	(pcs.)
M 5	22	63.5	100	77	10
M 6	22	63.5	100	78	10
M 8	22	63.5	100	80	10
M10	23	63.5	100	132	10
M12	23	63.5	100	136	10
M14	24	63.5	100	144	5
M16	25	60	100	250	5
M18	27	60	100	300	5

4020-120 (XZN)	D (mm)	H (mm)	L (mm)	(g)	(pcs.)
M 5	22	83.5	120	86	10
M 6	22	83.5	120	87	10
M 8	22	83.5	120	89	10
M10	23	83.5	120	152	10
M12	23	83.5	120	156	10
M14	24	83.5	120	164	5

4020-140 (XZN)	D (mm)	H (mm)	L (mm)	(g)	(pcs.)
M 5	22	103.5	140	95	10
M 6	22	103.5	140	96	10
M 8	22	103.5	140	98	10
M10	23	103.5	140	172	5
M12	23	103.5	140	176	5
M14	24	103.5	140	184	5

### XZN

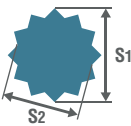

XZN		M4	M5	M6	M8	M10	M12	M14	M16	M18
S <sub>1</sub>	(ref. mm)	3.6	4.8	6.1	7.3	9.7	11.5	13.3	15.7	16.9
S <sub>2</sub>	(ref. mm)	3.1	4.1	5.1	6.1	8.1	9.7	11.2	13.2	14.2

## RS4020/6-L60 RS4020/6-L100

 Socket Set on Rail  
Steckschlüsselsatz auf Schiene  
Jeu de douilles sur rail



RS4020/6-L60	6 Pieces Set/Rail 150mm	(g)
<b>M5, M6, M8, M10, M12, M14</b>		500
RS4020/6-L100	6 Pieces Set/Rail 150mm	(g)
<b>M5, M6, M8, M10, M12, M14</b>		680

# 1/2"

Hand Sockets  
Hand Steckschlüssel  
Douilles à main

Z-SERIES  
HAND  
TITANIUM  
ACCESSORIES  
SCREWDRIVERS  
IMPACT  
SLEEVE-DRIVE  
PROTECTOR  
INDUSTRIAL  
AUTOMOTIVE  
MOTORCYCLE  
CONSTRUCTION  
SPARE PART

4025-60 (T)	D (mm)	H (mm)	L (mm)	(g)	(pcs.)
T15	22	23.5	60	58	10
T20	22	23.5	60	59	10
T25	22	23.5	60	60	10
T27	22	23.5	60	60	10
T30	22	23.5	60	60	10
T40	22	23.5	60	62	10
T45	22	23.5	60	64	10
T50	22	23.5	60	74	10
T55	23	23.5	60	96	10
T60	24	23.5	60	122	10
T70	24	23.5	60	135	10
T80	24	20	60	168	10

4025-100 (T)	D (mm)	H (mm)	L (mm)	(g)	(pcs.)
T20	22	73.5	100	76	10
T25	22	73.5	100	76	10
T27	22	73.5	100	77	10
T30	22	73.5	100	77	10
T40	22	73.5	100	78	10
T45	22	73.5	100	80	10
T50	22	73.5	100	98	10
T55	23	73.5	100	132	10
T60	24	73.5	100	170	5
T70	24	73.5	100	175	5

## 4025-60/-100/-140 (T)

TORX® Bit Sockets  
TORX® Bit-Steckschlüssel  
Douilles tournevis, TORX®

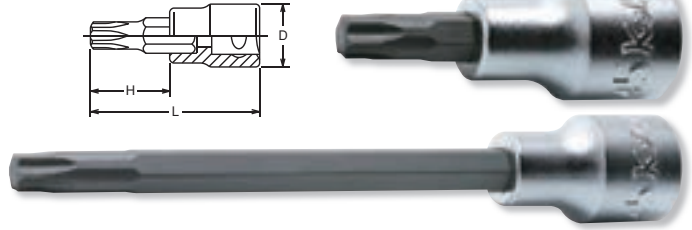

4025-140 (T)	D (mm)	H (mm)	L (mm)	(g)	(pcs.)
T20	22	103.5	140	94	10
T25	22	103.5	140	95	10
T27	22	103.5	140	95	10
T30	22	103.5	140	95	10
T40	22	103.5	140	97	10
T45	22	103.5	140	99	10
T50	22	103.5	140	129	10
T55	23	103.5	140	175	5
T60	24	103.5	140	229	5
T70	24	103.5	140	245	5
T80	24	100	140	320	5

RS4025/9-L60	9 Pieces Set/Rail 250mm	(g)
T20, T25, T27, T30, T40, T45, T50, T55, T60		700

## RS4025/9-L60



Socket Set on Rail  
Steckschlüsselsatz auf Schiene  
Jeu de douilles sur rail



### TORX® (T)

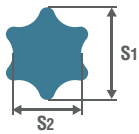

T	T8	T9	T10	T15	T20	T25	T27	T30	T40	T45	T50	T55	T60	T70	T80	T90	T100
S <sub>1</sub> (ref. mm)	2.3	2.5	2.7	3.3	3.9	4.5	5.0	5.6	6.7	7.9	8.9	11.3	13.3	15.6	17.6	20.0	22.2
S <sub>2</sub> (ref. mm)	1.7	1.8	2.0	2.3	2.8	3.2	3.6	4.0	4.8	5.6	6.2	8.0	9.5	11.1	12.7	14.2	15.8

4025-60 (IP)	D (mm)	H (mm)	L (mm)	(g)	(pcs.)
20IP	22	23.5	60	60	10
25IP	22	23.5	60	60	10
27IP	22	23.5	60	60	10
30IP	22	23.5	60	60	10
40IP	22	23.5	60	60	10
45IP	22	23.5	60	64	10
50IP	22	23.5	60	74	10
55IP	23	23.5	60	96	10
60IP	24	23.5	60	122	10
70IP	24	23.5	60	170	10

## 4025-60/-100 (IP)

TORXPLUS® Bit Sockets  
TORXPLUS® Bit-Steckschlüssel  
Douilles tournevis, TORXPLUS®

**TORXplus**

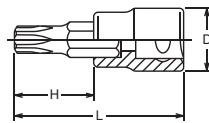

4025-100 (IP)	D (mm)	H (mm)	L (mm)	(g)	(pcs.)
40IP	22	63.5	100	79	10
45IP	22	63.5	100	81	10
50IP	22	63.5	100	100	10
55IP	23	63.5	100	133	10
60IP	24	63.5	100	172	5
70IP	25	63.5	100	241	5

## RS4025/9-IP



Socket Set on Rail  
Steckschlüsselsatz auf Schiene  
Jeu de douilles sur rail



RS4025/9-IP	9 Pieces set/Rail 250mm	(g)
20IP, 25IP, 27IP, 30IP, 40IP, 45IP, 50IP, 55IP, 60IP		700

### TORXPLUS® (IP)

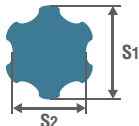

IP	8IP	9IP	10IP	15IP	20IP	25IP	27IP	30IP	40IP	45IP	50IP	55IP	60IP	70IP
S <sub>1</sub> (ref. mm)	2.3	2.5	2.7	3.3	3.9	4.5	5.0	5.6	6.7	7.9	8.9	11.3	13.3	15.6
S <sub>2</sub> (ref. mm)	1.7	1.8	2.0	2.3	2.8	3.2	3.6	4.0	4.8	5.6	6.2	8.0	9.5	11.1

TORX® is a registered trademark of Acument Intellectual Properties, LLC.  
TORX® ist ein registriertes Markenzeichen der Firma Acument Intellectual Properties, LLC.  
TORX® est une marque déposée de Acument Intellectual Properties, LLC.

TORXplus® is a registered trademark of Acument Intellectual Properties, LLC.  
TORXplus® ist ein registriertes Markenzeichen der Firma Acument Intellectual Properties, LLC.  
TORXplus® est une marque déposée de Acument Intellectual Properties, LLC.

# Hand Sockets Hand Steckschlüssel Douilles à main

## 1/2"

Z-SERIES  
HAND  
TITANIUM  
SCREWDRIVERS ACCESSORIES  
IMPACT  
SLEEVE-DRIVE  
PROTECTOR  
INDUSTRIAL  
AUTOMOTIVE  
MOTORCYCLE  
CONSTRUCTION  
SPARE PART

### 4025-60-T35

Bit Socket  
Bit-Steckschlüssel  
Douille tournevis



4025-60 (T)	D (mm)	H (mm)	L (mm)	(g)	(pcs.)
<b>T35</b>	22	23.5	60	96	10

For T35 Special screws

### 4027-60/-100/-140

Bit Sockets for Ribe Screws  
Steckschlüsselklingen für Ribe Schrauben  
Douilles tournevis pour écrous profil Ribe

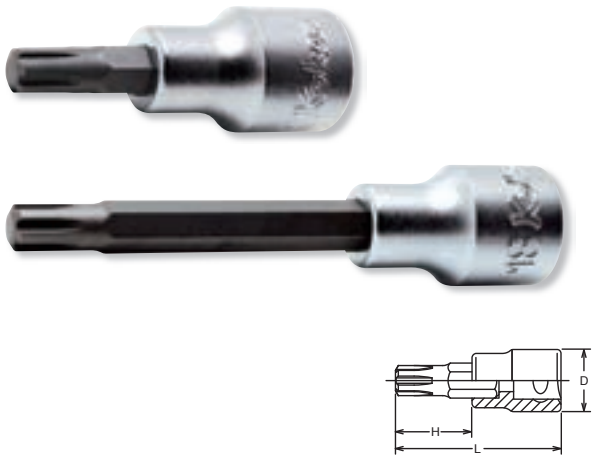

4027-60	D (mm)	H (mm)	L (mm)	(g)	(pcs.)
<b>M 5</b>	22	23.5	60	60	10
<b>M 6</b>	22	23.5	60	62	10
<b>M 7</b>	22	23.5	60	63	10
<b>M 8</b>	22	23.5	60	64	10
<b>M 9</b>	22	23.5	60	70	10
<b>M10</b>	22	23.5	60	74	10
<b>M12</b>	23	23.5	60	96	10
<b>M13</b>	24	23.5	60	116	10
<b>M14</b>	24	23.5	60	122	10
<b>M16</b>	24	25	60	135	10

4027-100	D (mm)	H (mm)	L (mm)	(g)	(pcs.)
<b>M 5</b>	22	63.5	100	67	10
<b>M 6</b>	22	63.5	100	68	10
<b>M 7</b>	22	63.5	100	75	10
<b>M 8</b>	22	63.5	100	81	10
<b>M 9</b>	22	63.5	100	90	10
<b>M10</b>	22	63.5	100	101	10
<b>M12</b>	23	63.5	100	134	10
<b>M13</b>	24	63.5	100	155	5
<b>M14</b>	24	63.5	100	173	5
<b>M16</b>	24	60	100	241	5

4027-140	D (mm)	H (mm)	L (mm)	(g)	(pcs.)
<b>M 8</b>	22	103.5	140	98	10
<b>M10</b>	22	103.5	140	127	10
<b>M12</b>	23	103.5	140	171	5
<b>M14</b>	24	103.5	140	226	5
<b>M16</b>	24	100	140	320	5

#### Ribe CV

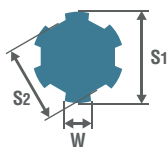

CV		M5	M6	M7	M8	M9	M10	M12	M13	M14	M16
W	(ref. mm)	1.2	1.3	1.4	1.8	2.0	2.3	2.6	3.1	3.2	3.6
S <sub>1</sub>	(ref. mm)	5.0	6.0	7.0	8.0	9.0	10.0	12.0	13.0	14.0	16.0
S <sub>2</sub>	(ref. mm)	3.8	4.5	5.0	6.0	7.1	7.4	9.0	11.0	10.4	11.9

### RS4027/7-L60

Socket Set on Rail  
Steckschlüsselsatz auf Schiene  
Jeu de douilles sur rail



RS4027/7-L60	7 Pieces set/Rail 200mm	(g)
<b>M5, M6, M8, M10, M12, M14, M16</b>		600

4101	T×W (mm)	D (mm)	L (mm)	(g)	(pcs.)
1	2.7×18.6	22	40	59	10
2	3.7×24	24	40	79	10
3	3.7×30	30	40	128	10

**4101**  Sockets for Slotted Heads  
Steckschlüssel für Schlitzschrauben  
Douilles tournevis pour vis à fente

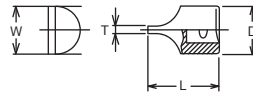

4137	D <sub>1</sub> (mm)	D <sub>2</sub> (mm)	L (mm)	(g)	(pcs.)
4137	13	22	38	53	10

**4137**  Bit Holder  
Klingenhälter  
Porte-embouts

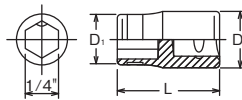

For DIN3126 C6.3 Bits  
Für DIN3126 C6.3 Bits  
Pour DIN3126 C6.3 Embouts

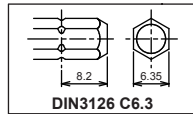

4138	D <sub>1</sub> (mm)	D <sub>2</sub> (mm)	L (mm)	(g)	(pcs.)
4138	16	22	38	62	10

**4138**  Bit Holder  
Klingenhälter  
Porte-embouts

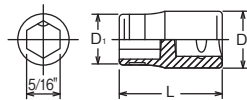

For DIN3126 C8 Bits  
Für DIN3126 C8 Bits  
Pour DIN3126 C8 Embouts

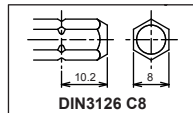

4141	D <sub>1</sub> (mm)	D <sub>2</sub> (mm)	L (mm)	(g)	(pcs.)
4141	16	22	52	70	10

**4141**  Bit Holder, extra deep for 131P-80, 131S-80, 131T-80  
Klingenhälter, extra tief für 131P-80, 131S-80, 131T-80  
Porte embout, ouverture longue pour 131P-80, 131S-80, 131T-80

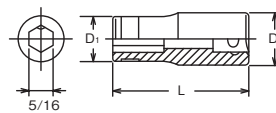

Hand Sockets  
Hand Steckschlüssel  
Douilles à main

# 1/2"

Z-SERIES  
HAND  
TITANIUM  
SCREWDRIVERS ACCESSORIES  
IMPACT  
SLEEVE-DRIVE  
PROTECTOR  
INDUSTRIAL  
AUTOMOTIVE  
MOTORCYCLE  
CONSTRUCTION  
SPARE PART

**3749S-1/2** Reversible Ratchet Short  
Knarre, verstellbar  
Cliquet, réversible



\* Renewal Kits → 3749SRK-1/2 → P299

**3749SB-1/2** Reversible Ratchet short with quick release button  
Knarre, verstellbar mit Verriegelungsknopf  
Cliquet, réversible avec bouton de débrayage

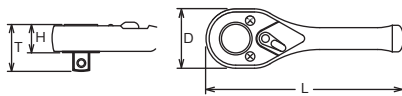

\* Renewal Kits → 3749SRK-1/2 → P299

	D (mm)	T (mm)	H (mm)	L (mm)	(g)	(pce.)
3749S-1/2	34	29	14.4	110	200	5
3749SB-1/2	34	29	14.4	110	200	5

⚠ Reversible Ratchet with quick release button has less strength compared with normal ratchet due to the technical design. Make sure to use the ratchet correctly.

**4752J** Reversible Ratchet  
Knarre, verstellbar  
Cliquet, réversible



\* Renewal Kits → 4752RK → P299

[L/R Marking]



A pointer and L/R markings on the ratchet head indicate the turning direction. The reduced diameter of the head allows easier access in tight spots.

Eine L/R Markierung auf dem Knarrenkopf zeigt die gerade eingestellte Drehrichtung an. Der geringe Kopfdurchmesser erleichtert das Arbeiten auch an schwer zugänglichen Stellen.

Un marquage L/R sur la tête de cliquet indique le sens de rotation. Le diamètre de tête réduit et facilite le travail dans les endroits difficilement accessibles.

**4752N** Reversible Ratchet  
Knarre, verstellbar  
Cliquet, réversible

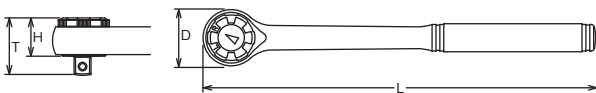

	D (mm)	T (mm)	H (mm)	L (mm)	(g)	(pce.)
4752J	35	38.8	24.5	250	470	1
4752N	35	38.8	24.5	250	480	1

## GEAR TEETH



4749series



4753series



4750series



4752series



4774series





\* Renewal Kits → 4750RK → P299

**4750J** Reversible Ratchet  
Knarre, verstellbar  
Cliquet, réversible



\* Renewal Kits → 4750RK → P299

**4750P** Reversible Ratchet  
Knarre, verstellbar  
Cliquet, réversible



\* Renewal Kits → 4750RK → P299

**4750N** Reversible Ratchet  
Knarre, verstellbar  
Cliquet, réversible



	D (mm)	T (mm)	H (mm)	L (mm)	(g)	(pce.)
4750J	38	35.9	21.3	250	508	1
4750P	38	35.9	21.3	250	553	1
4750N	38	35.9	21.3	250	548	1

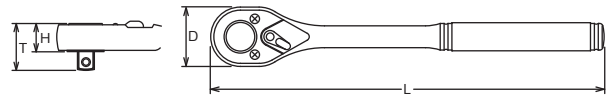

\* Renewal Kits → 4750BRK → P299

**4750JB** Reversible Ratchet with quick release button  
Knarre, verstellbar mit Verriegelungsknopf  
**4750PB** Cliquet, réversible avec bouton de débrayage ⚠  
**4750NB**



	D (mm)	T (mm)	H (mm)	L (mm)	(g)	(pce.)
4750JB	38	35.9	21.3	250	508	1
4750PB	38	35.9	21.3	250	553	1
4750NB	38	35.9	21.3	250	548	1

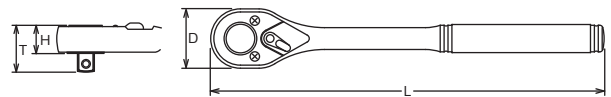

⚠ Reversible Ratchet with quick release button has less strength compared with normal ratchet due to the technical design. Make sure to use the ratchet correctly.

## [4750 series]

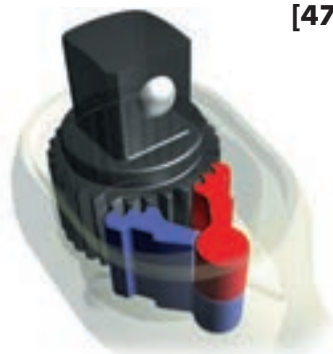

Two dogs are set in the same axis and the three teeth hold the ratchet gear. The enlarged contact area produces an about 10% higher torque value and the S.O.D.H system provides smooth and light movements.

Die scharnierartig eingelagerten Sperrklinken haben jetzt jeweils drei Zähne im Eingriff. Die dadurch vergrößerte Greiffläche erhöht das maximale Drehmoment um ca. 10%. Auch diese Knarre besticht durch ihren leichten und geschmeidigen Lauf.

Les deux rochets étant placés sur le même axe, les trois dents de l'engrenage sont engagées en permanence. Ce système assure une augmentation de 10% du couple maximum admissible. Ce cliquet se caractérise également par son fonctionnement souple et sans à-coup.

# Hand Sockets Hand Steckschlüssel Douilles à main

## 1/2"

Z-SERIES  
HAND  
TITANIUM  
SCREWDRIVERS ACCESSORIES  
IMPACT  
SLEEVE-DRIVE  
PROTECTOR  
INDUSTRIAL  
AUTOMOTIVE  
MOTORCYCLE  
CONSTRUCTION  
SPARE PART

**4753J** Reversible Ratchet  
Knarre, verstellbar  
Cliquet, réversible



\* Renewal Kits → 4753RK → P299

**4753P** Reversible Ratchet  
Knarre, verstellbar  
Cliquet, réversible



\* Renewal Kits → 4753RK → P299

**4753N** Reversible Ratchet  
Knarre, verstellbar  
Cliquet, réversible



\* Renewal Kits → 4753RK → P299

**D4753J** Reversible Ratchet  
Knarre, verstellbar  
Cliquet, réversible



\* Renewal Kits → 4753RK → P299

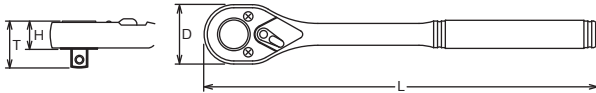

	D (mm)	T (mm)	H (mm)	L (mm)	(g)	(pce.)
4753J	38	36.2	21.6	250	545	1
4753P	38	36.2	21.6	250	570	1
4753N	38	36.2	21.6	250	595	1
D4753J	38	36.2	21.6	250	510	1

**4753JB** Reversible Ratchet with quick release button  
**4753PB** Knarre, verstellbar mit Verriegelungsknopf  
**4753NB** Cliquet, réversible avec bouton de débrayage



\* Renewal Kits → 4753BRK → P299

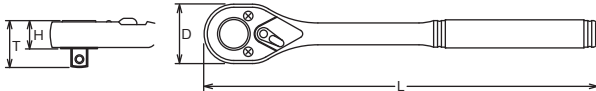

	D (mm)	T (mm)	H (mm)	L (mm)	(g)	(pce.)
4753JB	38	36.2	21.6	250	545	1
4753PB	38	36.2	21.6	250	570	1
4753NB	38	36.2	21.6	250	595	1

Reversible Ratchet with quick release button has less strength compared with normal ratchet due to the technical design. Make sure to use the ratchet correctly.



**Reversible Ratchet with Quick Release Button :**  
Sockets and accessories are safely locked. By pushing the button the sockets or extension bars are released from the ratchet.

**Umstellbare Knarre mit Verriegelungsknopf :**  
Steckschlüssel und Zubehörteile werden sicher und fest gehalten. Bei Drücken des Knopfes lösen sich die Teile.

**Cliquet réversible à verrouillage :**  
Les douilles et accessoires ne peuvent plus tomber. Une pression du pouce sur le bouton suffit pour les libérer.





\* Renewal Kits → 4749RK → P299

**4749J-380** Reversible Ratchet (long)  
**4749N-380** Verstellbare Knarre, lang  
Cliquet réversible, long



	D (mm)	T (mm)	H (mm)	L (mm)	(g)	(pce.)
4749J-380	44.6	33	18.4	380	743	1
4749N-380	44.6	33	18.4	380	753	1

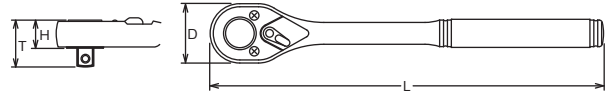

\* Renewal Kits → 4753RK → P299

**4753P-410** Reversible Ratchet (long)  
Verstellbare Knarre, lang  
Cliquet réversible, long



	D (mm)	T (mm)	H (mm)	L (mm)	(g)	(pce.)
4753P-410	38	36.2	21.6	410	790	1

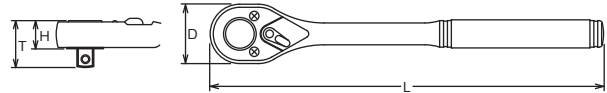

\* Renewal Kits → 4753RK → P299

**4774J** Flexible Ratchet, reversible  
**4774P** Gelenk-Knarre, verstellbar  
**4774N** Cliquet, articulé, réversible

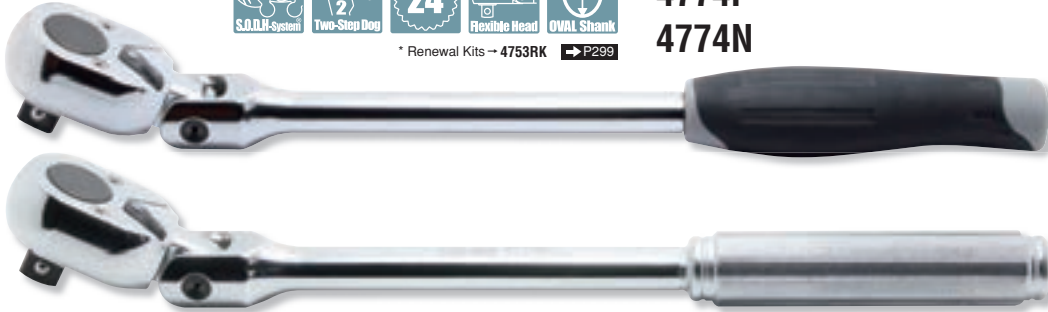

	D (mm)	T (mm)	H (mm)	L (mm)	(g)	(pce.)
4774J	38	36.2	21.6	330	685	1
4774P	38	36.2	21.6	330	700	1
4774N	38	36.2	21.6	330	700	1

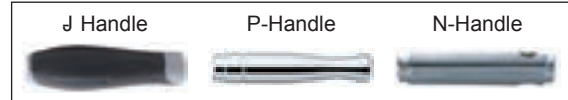
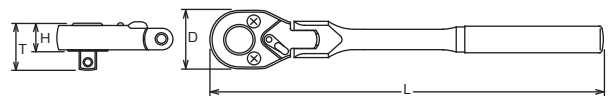

\* Renewal Kits → 4753RK → P299

**4774P-450** Flexible Ratchet, reversible  
Gelenk-Knarre, verstellbar ⚠  
Cliquet, articulé, réversible



	D (mm)	T (mm)	H (mm)	L (mm)	(g)	(pce.)
4774P-450	38	36.2	21.6	450	790	1

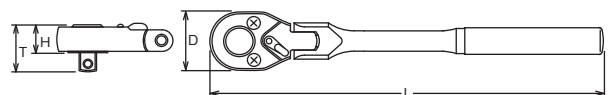

⚠ 4774P-450 has longer handle than standard, and can be loaded to excessive torque value. In the interest of your own safety always apply load evenly and progressively to avoid breakage and possible injury.

# Hand Sockets Hand Steckschlüssel Douilles à main

# 1/2"

Z-SERIES  
HAND  
TITANIUM  
SCREWDRIVERS  
ACCESSORIES  
IMPACT  
SLEEVE-DRIVE  
PROTECTOR  
INDUSTRIAL  
AUTOMOTIVE  
MOTORCYCLE  
CONSTRUCTION  
SPARE PART

**4774JB** Flexible Ratchet, reversible with quick release button   
**4774PB** Gelenk-Knarre, verstellbar mit Verriegelungsknopf  
**4774NB** Cliquet, articulé, réversible avec bouton de débrayage



\* Renewal Kits → **4753BRK** → **P299**

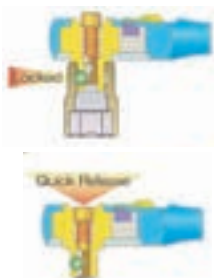
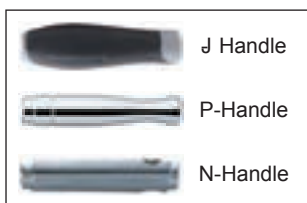
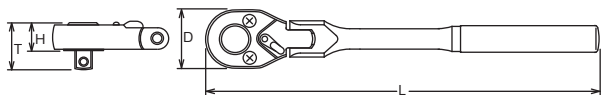

	D (mm)	T (mm)	H (mm)	L (mm)	(g)	(pcs.)
<b>4774JB</b>	38	36.2	21.6	330	685	1
<b>4774PB</b>	38	36.2	21.6	330	700	1
<b>4774NB</b>	38	36.2	21.6	330	700	1

 Reversible Ratchet with quick release button has less strength compared with normal ratchet due to the technical design. Make sure to use the ratchet correctly.

**Reversible Ratchet with Quick Release Button :**  
Sockets and accessories are safely locked. By pushing the button the sockets or extension bars are released from the ratchet.

**Umstellbare Knarre mit Verriegelungsknopf :**  
Steckschlüssel und Zubehörteile werden sicher und fest gehalten. Bei Drücken des Knopfes lösen sich die Teile.

**Cliquet réversible à verrouillage :**  
Les douilles et accessoires ne peuvent plus se libérer. Une pression du pouce sur le bouton suffit pour les extraire.

**4755** Ratchet Adaptor  
Aufsteckknarre  
Cliquet adaptable

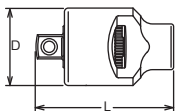

**45**

\* Renewal Kits → **4755RK** → **P300**

	D (mm)	L (mm)	(g)	(pcs.)
<b>4755</b>	33.5	65	270	5

**4756** Quick Spinner  
Rändel-Drehscheibe  
Lanceur

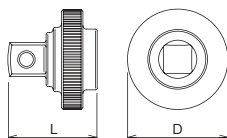

	D (mm)	L (mm)	(g)	(pcs.)
<b>4756</b>	38	34.5	95	10

**4768J-380/-450** Hinge Handles  
Gelenkgriffe  
Poignées articulées 



\* Renewal Kits → **4768RK** → **P300**



**4768P-380/-450** Hinge Handles  
Gelenkgriffe  
Poignées articulées 



\* Renewal Kits → **4768RK** → **P300**

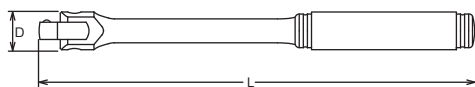

 4768-450 has longer handle than standard, and can be loaded to excessive torque value. Please use carefully.

	D (mm)	L (mm)	(g)	(pcs.)
<b>4768J-380</b>	28	380	600	1
<b>4768J-450</b>	28	450	690	1
<b>4768P-380</b>	28	380	665	2
<b>4768P-450</b>	28	450	748	2

4760	D (mm)	L (mm)	(g)	(pcs.)
50	24	50	92	10
75	24	75	138	10
100	24	100	158	5
125	24	125	194	5
150	24	150	266	5
200	24	200	295	5
250	24	250	358	5
300	24	300	492	2
400	24	400	650	1
500	24	500	808	1
600	24	600	968	1
900	24	900	1430	1
1000	24	1000	1593	1

PK4760/5 5 Pieces Set/△=1,050g  
PLASTIC TRAY

Extension Bars  
4760 Extension Bars  
50, 75, 125, 150, 250

Rotation and general handling of extensions with oily hands is greatly improved with the **Kokon** developed 6 point knurling. Also the **Kokon** 6 point knurling stops the extensions from rolling around the work area.

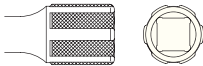

Durch die von **Kokon** entwickelte 6 fache Rändelung wird die Handhabung deutlich erleichtert. Außerdem wird das Herumrollen der Verlängerungen wirksam verhindert.

La manipulation des rallonges est grandement facilitée par le profil moleté développé par **Kokon**. Ce même profil empêche le roulement intempestif des rallonges sur le plan de travail.

4763	D (mm)	L (mm)	(g)	(pcs.)
50	24	50	95	10
75	24	75	111	10
125	24	125	157	5
150	24	150	181	5
250	24	250	357	5
400	24	400	650	1

⚠ The Wobble-Fix Extension Bar has less strength than normal extension bar due to it's specific design with a reduced square drive. Make sure to use it correctly.



PK4763/5 5 Pieces Set/△=950g  
PLASTIC TRAY

Extension Bars  
4763 Wobble-Fix Extension Bars  
50, 75, 125, 150, 250

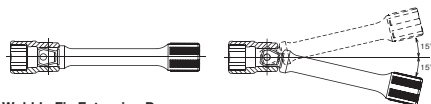

#### Wobble-Fix Extension Bar

Two way usage

- In a fixed position, as a normal extension bar
- In a half-fixed position, as a flexible extension bar providing a 15° angle operation

#### Winkel-Verlängerungen

Winkelverlängerungen lassen sich in zwei Einstellungen verwenden

- voll eingesteckt und starr,
- halb eingesteckt, mit einem Arbeitswinkel von 15°.

#### Rallonges angulaires

Deux utilisations possibles

- comme rallonge normale, dans une position fixe
- comme une rallonge angulaire avec une possibilité d'inclinaison jusqu'à 15°

## 4760-50/-75/-100/-125/-150/-200/-250/ -300/-400/-500/-600/-900/-1000

Extension Bars  
Verlängerungen  
Rallonges

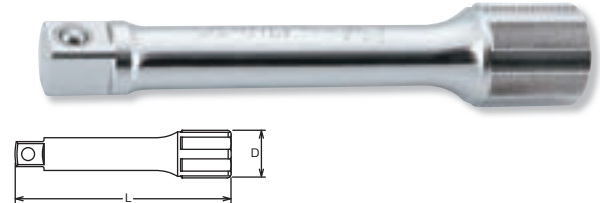

### PK4760/5

Extension Bars in Plastic Box  
Verlängerungen in Kunststoff-Kassette  
Rallonges en boîte plastique



## 4763-50/-75/-125/-150/-250/-400

Wobble-Fix Extension Bars  
Winkel-Verlängerungen  
Rallonges angulaires

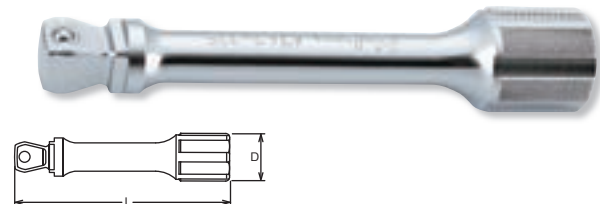

### PK4763/5

Wobble-Fix Extension Bars in Plastic Box  
Winkel Verlängerungen in Kunststoff-Kassette  
Rallonges angulaires en boîte plastique



Z-SERIES  
HAND  
TITANIUM  
SCREWDRIVERS ACCESSORIES  
IMPACT  
SLEEVE-DRIVE  
PROTECTOR  
INDUSTRIAL  
AUTOMOTIVE  
MOTORCYCLE  
CONSTRUCTION  
SPARE PART

**4770** Universal Joint  
Gelenk-Einsatz  
Cardan universel

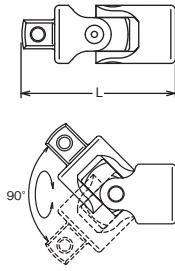

	L (mm)	(g)	(pcs.)
4770	62.4	150	10

**4771** Universal Joint  
Gelenk-Einsatz  
Joint articlé

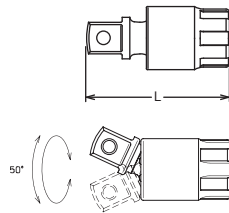

	L (mm)	(g)	(pcs.)
4771	57.7	113	10

**4780-400** Speed Handle  
Winde  
Vilebrequin

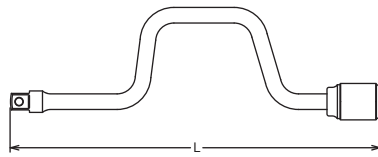

	L (mm)	(g)	(pce.)
4780	400	644	1

**4781N-450** Flexible Speed Handle  
Gelenkgriff-Winde  
Vilebrequin

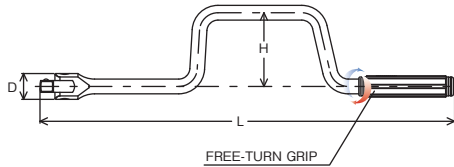

\* Renewal Kits → 4768RK → P300

	D (mm)	H (mm)	L (mm)	(g)	(pce.)
4781N-450	28	80	450	1000	1

**4785** T-Handle  
T-Griff  
Poignée coulissante

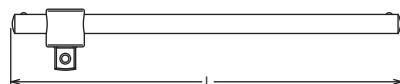

	L (mm)	(g)	(pcs.)
4785	300	410	2



# 1/2"

Hand Sockets  
Hand Steckschlüssel  
Douilles à main



**4747** L-Handle  
L-Griff  
Poignées en L



	L <sub>1</sub> (mm)	L <sub>2</sub> (mm)	(g)	(pcs.)
<b>4747</b>	260	50	470	1

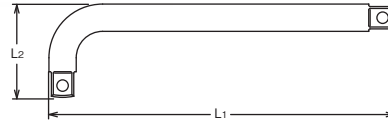

**4788-250/-300/-450** L-Handles  
L-Griffe  
Poignées en L



4788	L <sub>1</sub> (mm)	L <sub>2</sub> (mm)	(g)	(pcs.)
<b>250</b>	250	53	417	2
<b>300</b>	300	53	503	1
<b>450</b>	450	53	745	1

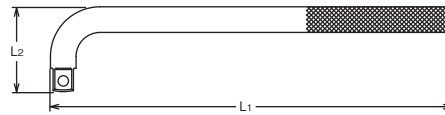

4433A	□ (sq.)	□ (sq.)	L (mm)	(g)	(pcs.)
<b>35</b>	1/2"	3/8"	35	50	10
<b>75</b>	1/2"	3/8"	75	120	10
<b>125</b>	1/2"	3/8"	125	164	5
<b>250</b>	1/2"	3/8"	250	275	5
<b>600</b>	1/2"	3/8"	600	530	1

Items in this catalogue marked can be loaded to torque values which may cause breakage.  
In the interest of your own safety always apply load evenly and progressively to avoid breakage and possible injury.

Die mit gekennzeichneten Artikel können bei Überbelastungen zu Bruch gehen. Aus Gründen Ihrer Sicherheit, sollten die betreffenden Werkzeuge nie ruckartig sondern nach und nach belastet werden, um Bruch und damit verbundene, mögliche Verletzungen zu vermeiden.

Il est possible d'appliquer aux articles marqués des couples de serrage susceptibles d'occasionner leur rupture. Pour votre propre sécurité, veuillez toujours appliquer la charge d'une manière uniforme et progressive. Ceci pour éviter ruptures et accidents.

**4433A-35/-75/-125/-250/-600**

Adaptors  
Verbindungsstücke  
Réducteurs

Warranty 290Nm  
Garantie 290Nm  
Garantie 290Nm

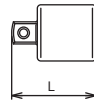

**4466A** Adaptor  
Verbindungsstück  
Réducteurs

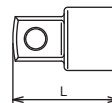

	□ (sq.)	□ (sq.)	L (mm)	(g)	(pcs.)
<b>4466A</b>	1/2"	3/4"	42	108	10

Z-SERIES  
HAND  
TITANIUM  
ACCESSORIES  
SCREWDRIVERS  
IMPACT  
SLEEVE-DRIVE  
PROTECTOR  
INDUSTRIAL  
AUTOMOTIVE  
MOTORCYCLE  
CONSTRUCTION  
SPARE PART

Hand Sockets  
Hand Steckschlüssel  
Douilles à main **1/2"**

Z-SERIES  
HAND  
TITANIUM  
SCREWDRIVERS  
ACCESSORIES  
IMPACT  
SLEEVE-DRIVE  
PROTECTOR  
INDUSTRIAL  
AUTOMOTIVE  
MOTORCYCLE  
CONSTRUCTION  
SPARE PART

**4223M-01** Socket Sets  
Steckschlüssel Sätze  
**4223M-06** Jeux de clés à douilles



**4238AM** Socket Sets  
Steckschlüssel Sätze  
Jeux de clés à douilles



**S4240M-01** ○ Display Stands  
**S4240A-00** ○ Ausstellungsstände  
**S4240M-06** ○ Présentoirs  
**S4240A-05** ○



**P4241M-01** Socket Sets  
Steckschlüssel Sätze  
**P4241M-06** Jeux de clés à douilles



**4223M-01** 15 Pieces Set/△=2,600g  
**4223M-06** 15 Pieces Set/△=2,600g

METAL CASE:W415xH120xT50mm

Sockets	Accessories
(4223M-01) <b>4401M</b> 6-pt. Sockets 10, 11, 12, 13, 14, 15, 16, 17, 18, 19, 21, 22	<b>4753J</b> <b>4760-125</b> <b>4770</b>
(4223M-06) <b>4406M</b> 12-pt. Sockets 10, 11, 12, 13, 14, 15, 16, 17, 18, 19, 21, 22	

**4238AM** 38 Pieces Set/△=8,050g

METAL CASE:W446xH266xT50mm

Sockets	Accessories
<b>4405M</b> 12-pt. Sockets 10, 11, 12, 13, 14, 15, 16, 17, 18, 19, 21, 22, 23, 24, 26, 27, 30, 32	<b>4753N</b> <b>4760-125</b> <b>4760-250</b> <b>4770</b> <b>4780</b> <b>4785</b>
<b>4405A</b> 12-pt. Sockets 3/8, 7/16, 1/2, 9/16, 5/8, 11/16, 3/4, 13/16, 7/8, 15/16, 1.1/16, 1.1/8, 1.1/4	
<b>4300C</b> Spark Plug Socket 20.8	

**S4240M-01** 4401M 117 Pieces Set/△=13,000g  
**S4240M-06** 4406M 117 Pieces Set/△=13,000g

DISPLAY STAND:W510xH150xT230mm

Sockets		
10mm:9pcs	16mm:9pcs	24mm:6pcs
11mm:9pcs	17mm:8pcs	27mm:5pcs
12mm:9pcs	19mm:7pcs	30mm:5pcs
13mm:9pcs	21mm:7pcs	32mm:4pcs
14mm:9pcs	22mm:6pcs	
15mm:9pcs	23mm:6pcs	

**S4240A-00** 4400A 103 Pieces Set/△=13,000g  
**S4240A-05** 4405A 103 Pieces Set/△=13,000g

DISPLAY STAND:W510xH150xT230mm

Sockets		
3/8" :9pcs	11/16":8pcs	1" :5pcs
7/16":9pcs	3/4" :7pcs	1.1/16":5pcs
1/2" :9pcs	13/16":7pcs	1.1/8" :5pcs
9/16":9pcs	7/8" :6pcs	1.3/16":5pcs
5/8" :9pcs	15/16":6pcs	1.1/4" :4pcs

**P4241M-01** 28 Pieces Set/△=6,400g

METAL CASE:W425xH332xT65mm

Sockets	Accessories
<b>4401M</b> 6-pt. Sockets 10, 11, 12, 13, 14, 15, 16, 17, 18, 19, 20, 21, 22, 23, 24, 25, 26, 27, 28, 29, 30, 32	<b>4753J</b> <b>4760-125</b> <b>4760-250</b> <b>4768J-380</b> <b>4770</b> <b>4785</b>





**P4241M-06** 28 Pieces Set/△=6,400g

METAL CASE:W425xH332xT65mm

Sockets	Accessories
<b>4406M</b> 12-pt. Sockets 10, 11, 12, 13, 14, 15, 16, 17, 18, 19, 20, 21, 22, 23, 24, 25, 26, 27, 28, 29, 30, 32	<b>4753J</b> <b>4760-125</b> <b>4760-250</b> <b>4768J-380</b> <b>4770</b> <b>4785</b>

4241M-01	28 Pieces Set/△=6,500g
4241M-06	28 Pieces Set/△=6,500g
4241M-10	28 Pieces Set/△=6,500g

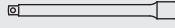
METAL CASE:W446xH266xT50mm

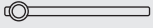



Sockets	Accessories
(4241M-01) <b>4401M</b> 6-pt. Sockets 10, 11, 12, 13, 14, 15, 16, 17, 18, 19, 20, 21, 22, 23, 24, 25, 26, 27, 28, 29, 30, 32	 <b>4753J</b>  <b>4760-125</b>  <b>4760-250</b>  <b>4768J-380</b>
(4241M-06) <b>4406M</b> 12-pt. Sockets 10, 11, 12, 13, 14, 15, 16, 17, 18, 19, 20, 21, 22, 23, 24, 25, 26, 27, 28, 29, 30, 32	 <b>4770</b>  <b>4785</b>
(4241M-10) <b>4410M</b> Surface Drive Sockets 10, 11, 12, 13, 14, 15, 16, 17, 18, 19, 20, 21, 22, 23, 24, 25, 26, 27, 28, 29, 30, 32	

**4241M-01** Socket Sets  
**4241M-06** Steckschlüssel Sätze  
**4241M-10** Jeux de clés à douilles

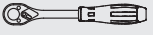

4241A-00	19 Pieces Set/△=4,900g
4241A-05	19 Pieces Set/△=4,900g

METAL CASE:W445xH190xT50mm

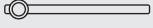



Sockets	Accessories
(4241A-00) <b>4400A</b> 6-pt. Sockets 3/8, 7/16, 1/2, 9/16, 5/8, 11/16, 3/4, 13/16, 7/8, 15/16, 1.1/16, 1.1/8, 1.1/4	 <b>4753J</b>  <b>4760-125</b>  <b>4760-250</b>  <b>4768J-380</b>
(4241A-05) <b>4405A</b> 12-pt. Sockets 3/8, 7/16, 1/2, 9/16, 5/8, 11/16, 3/4, 13/16, 7/8, 15/16, 1.1/16, 1.1/8, 1.1/4	 <b>4770</b>  <b>4785</b>

**4241A-00** Socket Sets  
**4241A-05** Steckschlüssel Sätze  
Jeux de clés à douilles



4249M-01	20 Pieces Set/△=4,800g
4249M-06	20 Pieces Set/△=4,800g

METAL CASE:W445xH190xT50mm

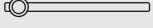



Sockets	Accessories
(4249M-01) <b>4401M</b> 6-pt. Sockets 10, 11, 12, 13, 14, 15, 16, 17, 18, 19, 21, 22, 24, 27, 30	 <b>4753J</b>  <b>4760-125</b>  <b>4760-250</b>
(4249M-06) <b>4406M</b> 12-pt. Sockets 10, 11, 12, 13, 14, 15, 16, 17, 18, 19, 21, 22, 24, 27, 30	 <b>4770</b>  <b>4785</b>

**4249M-01** Socket Sets  
**4249M-06** Steckschlüssel Sätze  
Jeux de clés à douilles



4250M-01	18 Pieces Set/△=4,700g
4250M-06	18 Pieces Set/△=4,700g
4250M-10	18 Pieces Set/△=4,700g

METAL CASE:W445xH190xT50mm

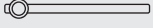
Sockets	Accessories
(4250M-01) <b>4401M</b> 6-pt. Sockets 10, 11, 12, 13, 14, 15, 17, 19, 22, 24, 27, 30, 32	 <b>4753J</b>  <b>4760-125</b>  <b>4760-250</b>
(4250M-06) <b>4406M</b> 12-pt. Sockets 10, 11, 12, 13, 14, 15, 17, 19, 22, 24, 27, 30, 32	 <b>4770</b>  <b>4785</b>
(4250M-10) <b>4410M</b> Surface Drive Sockets 10, 11, 12, 13, 14, 15, 17, 19, 22, 24, 27, 30, 32	

**4250M-01** Socket Sets  
**4250M-06** Steckschlüssel Sätze  
**4250M-10** Jeux de clés à douilles



Hand Sockets  
Hand Steckschlüssel 1/2"  
Douilles à main

Z-SERIES  
HAND  
TITANIUM  
SCREWDRIVERS ACCESSORIES  
IMPACT  
SLEEVE-DRIVE  
PROTECTOR  
INDUSTRIAL  
AUTOMOTIVE  
MOTORCYCLE  
CONSTRUCTION  
SPARE PART

**4251M-01** Socket Sets  
Steckschlüssel Sätze  
Jeux de clés à douilles  
**4251M-06**  
**4251M-10**  
**4251A-00**  
**4251A-05**



4251M-01	22 Pieces Set/⚖️=3,200g
4251M-06	22 Pieces Set/⚖️=3,200g
4251M-10	22 Pieces Set/⚖️=3,200g
4251A-00	18 Pieces Set/⚖️=2,700g
4251A-05	18 Pieces Set/⚖️=2,700g

METAL CASE:W330xH68xT48mm

Sockets	
(4251M-01) <b>4401M</b> 6-pt. Sockets	10, 11, 12, 13, 14, 15, 16, 17, 18, 19, 20, 21, 22, 23, 24, 25, 26, 27, 28, 29, 30, 32
(4251M-06) <b>4406M</b> 12-pt. Sockets	
(4251M-10) <b>4410M</b> Surface Drive Sockets	
(4251A-00) <b>4400A</b> 6-pt. Sockets	3/8, 7/16, 1/2, 9/16, 19/32, 5/8, 21/32, 11/16, 3/4, 25/32, 13/16, 7/8, 15/16, 1, 1.1/16, 1.1/8, 1.3/16, 1.1/4
(4251A-05) <b>4405A</b> 12-pt. Sockets	

**4252M-01** Socket Sets  
Steckschlüssel Sätze  
Jeux de clés à douilles  
**4252M-06**  
**4252M-10**



4252M-01	13 Pieces Set/⚖️=1,200g
4252M-06	13 Pieces Set/⚖️=1,200g
4252M-10	13 Pieces Set/⚖️=1,200g

METAL CASE:W168xH60xT42mm

Sockets	
(4252M-01) <b>4401M</b> 6-pt. Sockets	10, 11, 12, 13, 14, 15, 16, 17, 18, 19, 20, 21, 22
(4252M-06) <b>4406M</b> 12-pt. Sockets	
(4252M-10) <b>4410M</b> Surface Drive Sockets	

**4254** Socket Sets  
Steckschlüssel Sätze  
Jeux de clés à douilles



4254	12 Pieces Set/⚖️=1,070g
------	-------------------------

METAL CASE:W215xH80xT47mm

Sockets	Accessories
<b>3425</b> - E6, E8	<b>4763-50</b>
<b>4425</b> - E10, E12, E14	<b>4433A-35</b>
<b>3325</b> - E6, E8	
<b>4325</b> - E10, E12, E14	

**4262M-01** Socket Sets  
Steckschlüssel Sätze  
Jeux de clés à douilles  
**4262M-06**  
**4262M-10**



4262M-01	20 Pieces Set/⚖️=4,400g
4262M-06	20 Pieces Set/⚖️=4,400g
4262M-10	20 Pieces Set/⚖️=4,400g

METAL CASE:W445xH190xT50mm

Sockets	Accessories
(4262M-01) <b>4401M</b> 6-pt. Sockets 8, 10, 11, 12, 13, 14, 15, 16, 17, 18, 19, 21, 22, 24, 27	<b>4753J</b>
(4262M-06) <b>4406M</b> 12-pt. Sockets 8, 10, 11, 12, 13, 14, 15, 16, 17, 18, 19, 21, 22, 24, 27	<b>4760-125</b>
(4262M-10) <b>4410M</b> Surface Drive Sockets 8, 10, 11, 12, 13, 14, 15, 16, 17, 18, 19, 21, 22, 24, 27	<b>4760-250</b>
	<b>4770</b>
	<b>4785</b>



4272AM-01		29 Pieces Set/△=5,000g	
4272AM-06		29 Pieces Set/△=5,000g	
METAL CASE:W445xH190xT50mm			
Sockets		Accessories	
(4272AM-01)			
○	<b>4401M</b> 6-pt. Sockets 10, 11, 12, 13, 14, 15, 16, 17, 18, 19, 21, 22, 24		<b>4753J</b>
			<b>4760-125</b>
			<b>4760-250</b>
			<b>4770</b>
			<b>4785</b>
(4272AM-06)			
○	<b>4406M</b> 12-pt. Sockets 10, 11, 12, 13, 14, 15, 16, 17, 18, 19, 21, 22, 24		
○	<b>4405A</b> 12-pt. Sockets 3/8, 7/16, 1/2, 9/16, 5/8, 11/16, 3/4, 13/16, 7/8, 15/16, 1		

**4272AM-01** Socket Sets  
Steckschlüssel Sätze  
Jeux de clés à douilles

**4272AM-06**



4275		24 Pieces Set/△=5,340g	
METAL CASE:W445xH190xT50mm			
Sockets		Accessories	
○	<b>4406M</b> 12-pt. Sockets 10, 11, 12, 13, 14, 15, 16, 17, 18, 19, 21, 22, 24		<b>4750J</b>
○	<b>4300C</b> Spark Plug Sockets 16, 20.8		<b>4760-125</b>
			<b>4760-250</b>
○	<b>4300M</b> Wheel Nut Sockets 17(L60), 19(L60), 21(L60)		<b>4768J-380</b>
			<b>4770</b>
			<b>4785</b>

**4275** Socket Sets  
Steckschlüssel Sätze  
Jeux de clés à douilles



4276		17 Pieces Set/△=2,890g	
METAL CASE:W370xH150xT50mm			
Sockets		Accessories	
⦿	<b>4010M.50</b> Bit Sockets 6, 7, 8, 10, 12, 14		<b>4752J</b>
⦿	<b>4025.60</b> TORX® Bit Sockets T20, T25, T27, T30, T40, T45, T50, T55, T60		<b>4763-125</b>

**4276** Socket Sets  
Steckschlüssel Sätze  
Jeux de clés à douilles



4277		27 Pieces Set/△=5,660g	
METAL CASE:W445xH190xT50mm			
Sockets		Accessories	
○	<b>4406M</b> 12-pt. Sockets 10, 12, 13, 14, 15, 16, 17, 18, 19, 21, 22, 24		<b>4750J</b>
			<b>4760-125</b>
			<b>4768J-380</b>
○	<b>4305M</b> 12-pt. Deep Sockets 10, 12, 13, 14, 15, 16, 17, 18, 19, 21, 22, 24		

**4277** Socket Sets  
Steckschlüssel Sätze  
Jeux de clés à douilles



Z-SERIES  
HAND  
TITANIUM  
SCREWDRIVERS ACCESSORIES  
IMPACT  
SLEEVE-DRIVE  
PROTECTOR  
INDUSTRIAL  
AUTOMOTIVE  
MOTORCYCLE  
CONSTRUCTION  
SPARE PART

## 6400M / 6400A

6-point Sockets  
6-kant Steckschlüssel  
Douilles 6-pans

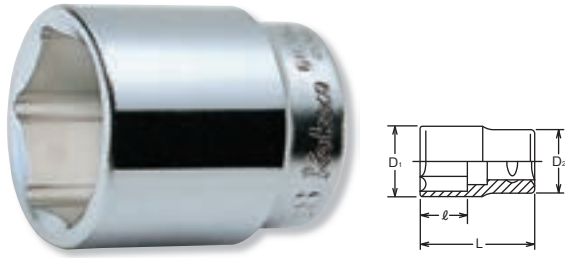

6400M 6405M (mm)	D <sub>1</sub> (mm)	D <sub>2</sub> (mm)	ℓ (mm)	L (mm)	(g)	(pcs.)
New 14	22.1	34	11	50	160	10
New 16	24.6	34	12	50	167	10
17	26	34	12.5	50	175	5
18	27	34	13	50	178	5
19	28.5	34	13.5	50	179	5
20	29.5	34	14	50	185	5
21	31	34	14.5	50	185	5
22	32	34	15	50	187	5
23	33.5	34	16	50	187	5
24	34.5	34	17	50	200	5
25	36	34	17.5	50	217	5
26	37	34	18	50	222	5
27	38.5	37	19	53	254	5
28	39.5	38	19.5	53	298	5
29	41	38	20	55	292	5
30	42	38	21	55	301	5
31	43.5	38	22	57	294	5
32	44.5	40	23	57	351	5
33	46	40	23.5	57	384	5
34	47	40	24	57	397	5
35	48.5	42	24.5	59	422	5
36	49.5	42	25	59	438	5
37	51	42	25.5	59	484	5
38	52	45	26	59	523	5
39	53.5	45	26.5	59	538	5
40	54.5	45	27	62	550	5
41	56	47	28	62	633	5
42	57	47	28.5	62	652	2
43	58.5	47	29	62	659	2
44	59.5	47	29.5	62	657	2
45	61	47	30	68	734	2
46	62	47	31	68	791	2
47	63.5	48	31.5	68	816	2
48	64.5	45	32	68	800	2
50	67	48	34	68	880	2
52	69.5	53	33	72	925	2
54	72	55	33	72	1040	2
55	73.5	53	36	72	1006	2
56	74.5	53	36	72	1092	2
57	76	53	36	72	1169	2
58	77	53	36	72	1149	2
60	79.5	58	39	76	1402	2
63	83.5	58	39	76	1494	2
65	86	63	42	80	1608	2
70	92	68	45	84	1785	2
75	98.5	73	48	86	2186	1
78	102.1	73	55	86	2425	1
80	104.5	78	52	90	2475	1
85	111	78	52	90	2620	1

## 6405M / 6405A

12-point Sockets  
12-kant Steckschlüssel  
Douilles 12-pans



6400A 6405A (inch)	D <sub>1</sub> (mm)	D <sub>2</sub> (mm)	ℓ (mm)	L (mm)	(g)	(pcs.)
New 5/8	24.6	34	12	50	168	10
11/16	27	34	13	50	178	5
3/4	28.5	34	13.5	50	179	5
25/32	29.5	34	14	50	185	5
13/16	31	34	14.5	50	185	5
7/8	32	34	15	50	187	5
15/16	34.5	34	17	50	200	5
31/32	36	34	17.5	50	217	5
1	37	34	18	50	222	5
1. 1/16	38.5	37	19	53	254	5
1. 1/8	41	38	20	53	292	5
1. 3/16	42	38	21	55	301	5
1. 1/4	44.5	40	23	57	351	5
1. 5/16	46	40	23.5	57	384	5
1. 3/8	48.5	42	24.5	57	422	5
1. 7/16	51	42	25.5	59	484	5
1. 1/2	52	45	26	59	523	5
1. 9/16	54.5	45	27	59	550	5
1. 5/8	56	47	28	62	633	5
1.11/16	58.5	47	29	62	659	2
1. 3/4	59.5	47	29.5	62	657	2
1.13/16	62	47	31	68	791	2
1. 7/8	64.5	45	32	68	892	2
1.15/16	66	48	32.5	68	870	2
2	68.5	52	34.5	68	949	2
2. 1/16	71	54	33	72	983	2
2. 1/8	72	55	33	72	1040	2
2. 3/16	74.5	53	36	72	1092	2
2. 1/4	76	53	36	72	1169	2
2. 5/16	78.5	53	36	72	1344	2
2. 3/8	79.5	58	39	76	1402	2
2. 7/16	82	58	39	76	1420	2
2. 1/2	84.5	58	39	76	1497	2
2. 9/16	86	63	42	80	1608	2
2. 5/8	88.5	63	42	80	1709	2
2.11/16	89.5	63	42	80	1634	2
2. 3/4	92	68	45	84	1785	2
2.13/16	94.5	68	45	84	2018	2
2. 7/8	96	68	45	84	2062	2
2.15/16	98.5	73	48	86	2186	1
3	101	73	48	86	2309	1
3. 1/8	104.5	78	52	90	2475	1

## 6425



TORX® Sockets  
TORX® Steckschlüssel  
Douilles TORX®



6425 (E)	D <sub>1</sub> (mm)	D <sub>2</sub> (mm)	ℓ (mm)	L (mm)	(g)	(pcs.)
E18	22.1	34	11.9	50	156	5
E20	24.6	34	13.3	50	166	5
E22	27.1	34	14.4	50	178	5
E24	28.6	34	16	50	185	5
E26	31.1	34	17.7	55	217	5
E28	32.1	34	24.1	60	237	5
E30	35	34	24.1	60	242	5
E32	36.1	34	24.1	60	247	5

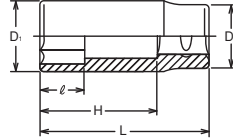

## 6300M / 6300A 6-point Deep Sockets 6-kant-Steckschlüssel,lang Douilles longues 6-pans





6300M 6305M (mm)	D <sub>1</sub> (mm)	D <sub>2</sub> (mm)	ℓ (mm)	H (mm)	L (mm)	 (g)	 (pcs.)
17	26	34	18	64	90	278	5
18	27	34	19	64	90	281	5
19	28.5	34	20	64	90	292	5
20	29.5	34	21	64	90	334	5
21	31	34	22	64	90	343	5
22	32	34	23	64	90	347	5
23	33.5	34	24	64	90	361	5
24	34.5	34	25	64	90	352	5
25	36	34	26	64	90	369	5
26	37	34	27	64	90	384	5
27	38.5	37	28	64	90	425	5
28	39.5	38	29	63	90	470	5
29	41	38	30	63	90	503	5
30	42	38	31	63	90	503	5
31	43.5	38	32	62	90	517	5
32	44.5	40	34	62	90	544	5
33	46	40	34	62	90	557	5
34	47	40	35	61	90	570	5
35	48.5	42	36	61	90	622	5
36	49.5	42	37	61	90	631	2
38	52	45	39	60	90	710	2
40	54.5	45	41	60	90	742	2
41	56	47	42	59	90	802	2
42	57	47	43	59	90	829	2
44	59.5	47	45	59	90	838	2
46	62	47	47	58	90	906	2
48	64.5	50	49	57	90	998	2
50	67	48	51	57	90	1005	2
52	69.5	53	49	-	100	1270	2
53	71	54	49	-	100	1338	2
54	72	55	49	-	100	1351	2
55	73.5	53	52	-	100	1388	2
56	74.5	53	52	-	100	1389	2
57	76	53	52	-	100	1467	2
58	77	53	52	-	100	1480	2
60	79.5	58	55	-	100	1626	2
63	83.5	58	55	-	100	1740	2
<b>65</b>	86	63	65	-	100	1939	2

## 6305M / 6305A 12-point Deep Sockets 12-kant Steckschlüssel,lang Douilles longues, 12-pans



6300A 6305A (inch)	D <sub>1</sub> (mm)	D <sub>2</sub> (mm)	ℓ (mm)	H (mm)	L (mm)	 (g)	 (pcs.)
3/4	28.5	34	20	64	90	292	5
25/32	29.5	34	21	64	90	334	5
13/16	31	34	22	64	90	343	5
7/8	32	34	23	64	90	347	5
15/16	34.5	34	25	64	90	352	5
1	37	34	27	64	90	384	5
1. 1/16	38.5	37	28	64	90	425	5
1. 1/8	41	38	30	63	90	503	5
1. 3/16	42	38	31	63	90	503	5
1. 1/4	44.5	40	34	62	90	544	5
1. 5/16	46	40	34	62	90	557	5
1. 3/8	48.5	42	36	61	90	622	5
1. 7/16	51	42	38	61	90	656	2
1. 1/2	52	45	39	60	90	710	2
1. 9/16	54.5	45	41	60	90	742	2
1. 5/8	56	47	42	59	90	802	2
1.11/16	58.5	47	44	59	90	831	2
1. 3/4	59.5	47	45	59	90	838	2
1.13/16	62	47	47	58	90	906	2
2	68.5	52	52	57	90	1061	2
2. 1/16	71	54	49	-	100	1338	2
2. 1/8	72	55	49	-	100	1351	2
2. 3/16	74.5	53	52	-	100	1389	2
2. 1/4	76	53	52	-	100	1467	2
2. 5/16	78.5	53	52	-	100	1787	2
2. 3/8	79.5	58	55	-	100	1626	2
2. 7/16	82	58	55	-	100	1715	2

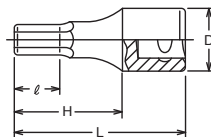

6012M.75 (mm)	D (mm)	ℓ (mm)	H (mm)	L (mm)	 (g)	 (pcs.)
12	35	15.5	40	75	253	10
14	35	15.5	40	75	265	10
15	35	15.5	40	75	271	10
16	35	15.5	40	75	285	10
17	35	15.5	40	75	292	10
18	35	15.5	40	75	302	10
19	35	15.5	40	75	312	10
20	35	15.5	40	75	323	10
<b>21</b>	38	15.5	40	75	330	10
22	38	22.5	40	75	340	10
24	38	22.5	40	75	362	10
27	38	22.5	40	75	402	10
30	38	28.5	40	75	445	10
32	38	28.5	40	75	485	10
36	42	28.5	40	75	663	10

## 6012M-75 Inhex Sockets Steckschlüssel für Innensechskant-Schrauben Douilles tournevis pour vis 6-pans creux

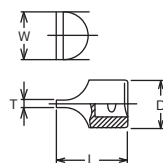

## 6101 Socket for Slotted Heads Steckschlüssel für Schlitzschrauben Douilles tournevis pour vis à fente



	T×W (mm)	D (mm)	L (mm)	 (g)	 (pcs.)
6101	6.4×33.5	35	50	205	10

Z-SERIES  
HAND  
TITANIUM  
SCREWDRIVERS ACCESSORIES  
IMPACT  
SLEEVE-DRIVE  
PROTECTOR  
INDUSTRIAL  
AUTOMOTIVE  
MOTORCYCLE  
CONSTRUCTION  
SPARE PART

## 6749 / 6749-1000 6749-HEAD PIPE-400/-800

Reversible Ratchet  
Knarre, verstellbar  
Cliquet, réversible



\* Renewal Kits → 6749RK → P299

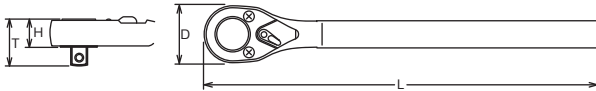

	Ø (mm)	T (mm)	H (mm)	L (mm)	⚖️ (g)	📦 (pce.)
6749	68	49.6	29.6	565	2840	1
6749-1000	68	49.6	29.6	965	3960	1
New 6749-HEAD	68	49.6	29.6	165	1730	1
New PIPE-400	-	-	-	400	1110	1
New PIPE-800	-	-	-	800	2230	1



## 6752 6752-HEAD PIPE-400

Reversible Ratchet  
Knarre, verstellbar  
Cliquet, réversible



\* Renewal Kits → 6752RK → P299

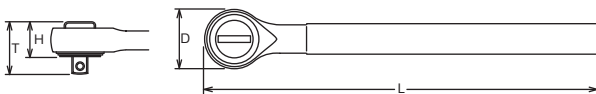

	D (mm)	T (mm)	H (mm)	L (mm)	⚖️ (g)	📦 (pce.)
6752	67	55.5	35.5	500	2360	1
New 6752-HEAD	67	55.5	35.5	100	1250	1
New PIPE-400	-	-	-	400	1110	1



# 3/4"

Hand Sockets  
Hand Steckschlüssel  
Douilles à main

60

\* Renewal Kits → 6755RK → P300

	D (mm)	L (mm)	(g)	(pce.)
6755	62	97	1162	1

**6755** Ratchet Adaptor  
Aufstecknarre  
Cliquet adaptable

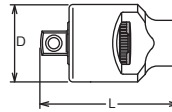

**6760-75/-100/-125/-150/-200/-300/-400**

Extension Bars  
Verlängerungen  
Rallonges



6760	D (mm)	L (mm)	(g)	(pce.)
75	35	75	335	10
100	35	100	434	10
125	35	125	528	10
150	35	150	624	2
200	35	200	815	1
300	35	300	1203	1
400	35	400	1585	1

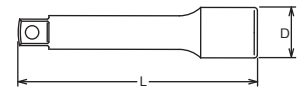

**6768** Hinge Handle  
Gelenkgriff  
Poignée articulée



\* Renewal Kits → 6768RK → P300

	D (mm)	L (mm)	(g)	(pce.)
6768	42	450	1715	1

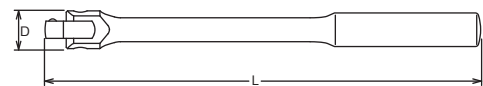

**6768-600/-1000** Hinge Handle  
Gelenkgriff  
Poignée articulée  
**6768-HEAD**  
**PIPE-400/800**



\* Renewal Kits → 6768RK → P300

6768	D (mm)	L (mm)	(g)	(pce.)
6768-600	42	600	2360	1
6768-1000	42	1000	3480	1
New 6768-HEAD	42	200	1250	1
New PIPE-400	-	400	1110	1
New PIPE-800	-	800	2230	1

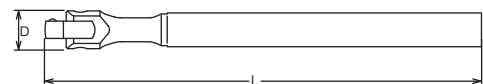

Z-SERIES  
HAND  
TITANIUM  
ACCESSORIES  
SCREWDRIVERS  
IMPACT  
SLEEVE-DRIVE  
PROTECTOR  
INDUSTRIAL  
AUTOMOTIVE  
MOTORCYCLE  
CONSTRUCTION  
SPARE PART

Z-SERIES  
HAND  
TITANIUM  
SCREWDRIVERS ACCESSORIES  
IMPACT  
SLEEVE-DRIVE  
PROTECTOR  
INDUSTRIAL  
AUTOMOTIVE  
MOTORCYCLE  
CONSTRUCTION  
SPARE PART

**6785** T-Handle  
T-Griff  
Poignée coulissante

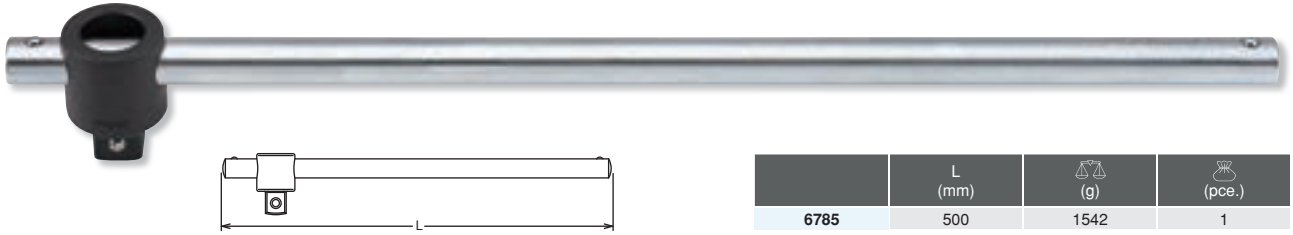

	L (mm)	(g)	(pce.)
<b>6785</b>	500	1542	1

**6788** L-Handle  
L-Griff  
Poignée en L

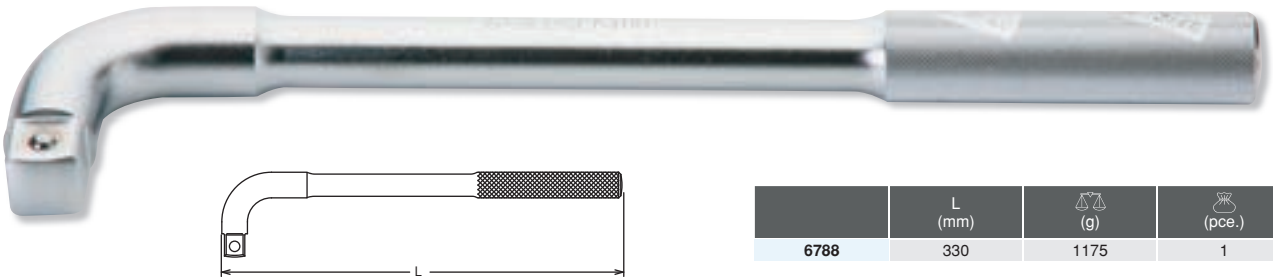

	L (mm)	(g)	(pce.)
<b>6788</b>	330	1175	1

**6770** Universal Joint  
Gelenk-Einsatz  
Cardan universel

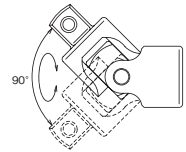

	L (mm)	(g)	(pcs.)
<b>6770</b>	105	478	2

**6644A** Adaptor  
Verbindungsstück  
Réducteur

Warranty 668Nm  
Garantie 668Nm  
Garantie 668Nm



	(sq.)	(sq.)	L (mm)	(g)	(pcs.)
<b>6644A</b>	3/4"	1/2"	47	136	5
<b>6688A</b>	3/4"	1"	60	285	5

Adapting down from bigger square drive to smaller square drive may lead to excessive torque load and possibly cause breakage. Always stay within safe torque of the smaller square drive.

Die mit gekennzeichneten Artikel können bei Überbelastung zu Bruch gehen. Aus Gründen Ihrer eigenen Sicherheit sollten die betreffenden Werkzeuge nie ruckartig, sondern nach und nach belastet werden, um Bruch und damit verbundene mögliche Verletzungen zu vermeiden.

Il est possible d'appliquer aux articles marqués des couples de serrage susceptibles d'occasionner leur rupture. Pour votre propre sécurité, veuillez toujours appliquer la charge d'une manière uniforme et progressive. Ceci pour éviter ruptures et accidents.

**6688A** Adaptor  
Verbindungsstück  
Augmentateur



# 3/4"

Hand Sockets  
Hand Steckschlüssel  
Douilles à main

**6201M-00**  
**6201A-00**  
**6201M-05**  
**6201A-05**

Socket Sets  
Steckschlüssel Sätze  
Jeux de clés à douilles



6201A-00 18 Pieces Set/△=17,600g  
6201A-05 18 Pieces Set/△=17,600g

METAL CASE:W580xH200xT85mm

Sockets	Accessories
(6201A-00) <b>6400A</b> 6-pt. Sockets 7/8, 15/16, 1.1/16, 1.1/8, 1.1/4, 1.5/16, 1.7/16, 1.1/2, 1.5/8, 1.11/16, 1.13/16, 1.7/8, 2	<b>6749</b> <b>6760-200</b> <b>6760-400</b> <b>6768</b> <b>6785</b>
(6201A-05) <b>6405A</b> 12-pt. Sockets 7/8, 15/16, 1.1/16, 1.1/8, 1.1/4, 1.5/16, 1.7/16, 1.1/2, 1.5/8, 1.11/16, 1.13/16, 1.7/8, 2	

6201M-00 16 Pieces Set/△=17,300g  
6201M-05 16 Pieces Set/△=17,300g

METAL CASE:W580xH200xT85mm

Sockets	Accessories
(6201M-00) <b>6400M</b> 6-pt. Sockets 22, 24, 27, 30, 32, 36, 41, 46, 50, 55, 60	<b>6749</b> <b>6760-200</b> <b>6760-400</b> <b>6768</b> <b>6785</b>
(6201M-05) <b>6405M</b> 12-pt. Sockets 22, 24, 27, 30, 32, 36, 41, 46, 50, 55, 60	

**6212M-00**  
**6212M-05**

Socket Sets  
Steckschlüssel Sätze  
Jeux de clés à douilles



6212M-00 12 Pieces Set/△=8,200g  
6212M-05 12 Pieces Set/△=8,200g

METAL CASE:W580xH124xT70mm

Sockets	Accessories
(6212M-00) <b>6400M</b> 6-pt. Sockets 22, 24, 27, 30, 32, 36, 41, 46, 50	<b>6749</b> <b>6760-200</b> <b>6785</b>
(6212M-05) <b>6405M</b> 12-pt. Sockets 22, 24, 27, 30, 32, 36, 41, 46, 50	

Z-SERIES  
HAND  
TITANIUM  
ACCESSORIES  
SCREWDRIVERS  
IMPACT  
SLEEVE-DRIVE  
PROTECTOR  
INDUSTRIAL  
AUTOMOTIVE  
MOTORCYCLE  
CONSTRUCTION  
SPARE PART



Z-SERIES  
HAND  
TITANIUM  
SCREWDRIVERS  
ACCESSORIES  
IMPACT  
SLEEVE-DRIVE  
PROTECTOR  
INDUSTRIAL  
AUTOMOTIVE  
MOTORCYCLE  
CONSTRUCTION  
SPARE PART

**8405M / 8405A** 12-point Sockets  
12-kant Steckschlüssel  
Douilles 12-pans

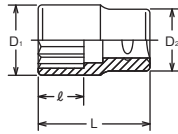

**8400M / 8400A** 6-point Sockets  
6-kant Steckschlüssel  
Douilles 6-pans

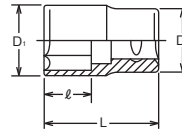

8400A 8405A (inch)	D <sub>1</sub> (mm)	D <sub>2</sub> (mm)	ℓ (mm)	L (mm)	(g)	(pce.)
15/16	36.5	44	17	60	355	1
1. 3/16	44	45	21	65	410	1
1. 1/4	46.5	45	23	65	455	1
1. 5/16	48	46	23.5	65	485	1
1. 3/8	50.5	48	24.5	65	536	1
1. 7/16	53	50	25.5	65	607	1
1. 1/2	54	50	26	65	624	1
1. 9/16	56.5	53	27	65	686	1
1. 5/8	58	53	28	68	747	1
1.11/16	60.5	53	29	68	830	1
1. 3/4	61.5	53	29.5	68	807	1
1.13/16	64	53	31	72	928	1
1. 7/8	66.5	53	32	72	936	1
1.15/16	68	53	32.5	72	941	1
2	70.5	53	37	72	976	1
2. 1/16	73	54	37	72	1027	1
2. 1/8	74	55	37	72	1016	1
2. 3/16	76.5	53	41	77	1192	1
2. 1/4	78	53	41	77	1177	1
2. 5/16	80.5	53	41	77	1292	1
2. 3/8	81.5	58	46	82	1440	1
2. 7/16	84	58	45	82	1495	1
2. 1/2	86.5	58	45	82	1497	1
2. 9/16	88	63	49	86	1683	1
2. 5/8	90.5	63	49	86	1840	1
2.11/16	91.5	63	49	86	1800	1
2. 3/4	94	68	50	88	1963	1
2.13/16	96.5	68	50	88	2035	1
2. 7/8	98	70	50	88	2100	1
2.15/16	100.5	73	53	90	2204	1
3	103	75	53	90	2406	1
3. 1/8	106.5	75	58	95	2550	1
3. 1/4	110.5	78	57	95	2730	1
3. 3/8	114	80	57	95	3050	1
3. 1/2	119	80	59	100	3420	1
3. 3/4	125.5	85	58	100	4900	1

8400M 8405M (mm)	D <sub>1</sub> (mm)	D <sub>2</sub> (mm)	ℓ (mm)	L (mm)	(g)	(pce.)
24	36.5	44	17	60	348	1
27	40.5	44	19	60	362	1
New 28	41.5	44	19.5	60	368	1
New 29	43	44	20	60	378	1
30	44	45	21	65	410	1
32	46.5	45	23	65	455	1
33	48	46	23.5	65	485	1
New 34	49	46	24	65	500	1
35	50.5	48	24.5	65	536	1
36	51.5	48	25	65	600	1
38	54	50	26	65	624	1
40	56.5	53	27	65	686	1
41	58	53	28	68	747	1
42	59	53	28.5	68	789	1
46	64	53	31	72	928	1
50	69	53	34	72	943	1
54	74	55	37	72	1016	1
55	75.5	53	42	77	1167	1
New 56	76.5	53	42	77	1160	1
58	79	53	41	77	1200	1
60	81.5	58	46	82	1440	1
63	85.5	58	45	82	1470	1
65	88	63	49	86	1683	1
67	90.5	63	49	86	1840	1
68	91.5	63	49	86	1800	1
70	94	68	50	88	1963	1
71	95.5	68	50	88	2200	1
75	100.5	73	53	90	2204	1
78	104	75	52.5	90	2500	1
80	106.5	75	58	95	2550	1
83	110.5	78	57	95	2730	1
85	113	80	57	95	2680	1
90	119	80	59	100	3420	1
95	125.5	85	58	100	4900	1
100	131.5	85	57	100	4840	1



8012M-80 (mm)	D (mm)	ℓ (mm)	H (mm)	L (mm)	(g)	(pcs.)
17	44.2	15.5	45	80	400	5
19	44.2	15.5	45	80	410	5
22	47.9	22.5	45	80	436	5
24	47.9	22.5	45	80	471	5
27	47.9	22.5	45	80	526	5
30	47.9	22.5	45	80	658	5
32	47.9	22.5	45	80	715	5
36	54.2	22.5	45	80	945	5

## 8012M-80

**Inhex Sockets**  
Steckschlüssel für Innensechskant-Schrauben  
Douilles tournevis pour vis 6-pans creux

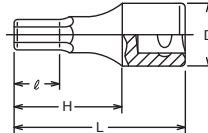

8760	D (mm)	L (mm)	(g)	(pce.)
200	44	200	1300	1
400	44	400	2570	1

## 8760-200/-400

**Extension Bars**  
Verlängerungen  
Rallonges



8770	L (mm)	(g)	(pce.)
8770	143	1170	1

## 8770

**Universal Joint**  
Gelenk-Einsatz  
Cardan universel

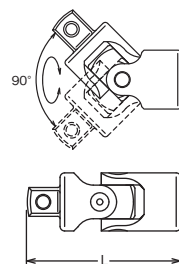

8866A	(mm)	(mm)	L (mm)	(g)	(pcs.)
8866A	1"	3/4"	60	338	5

**⚠** Adapting down from bigger square drive to smaller square drive may lead to excessive torque and possibly cause breakage.

Reduzierstücke sind mit Vernunft einzusetzen.  
Es besteht Bruchgefahr. Überschreiten Sie niemals die Sicherheitsgrenzen.

Les réducteurs doivent être utilisés avec modération. Ne dépassez jamais les limites de sécurité.

## 8866A

**Adaptor**  
Verbindungsstück  
Réducteur

Warranty 1850Nm  
Garantie 1850Nm  
Garantie 1850Nm **⚠**

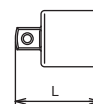

Z-SERIES  
HAND  
TITANIUM  
SCREWDRIVERS ACCESSORIES  
IMPACT  
SLEEVE-DRIVE  
PROTECTOR  
INDUSTRIAL  
AUTOMOTIVE  
MOTORCYCLE  
CONSTRUCTION  
SPARE PART

**8749**  
**8749-HEAD**  
**PIPE-580/-800**

Reversible Ratchet  
Knarre, verstellbar  
Cliquet, réversible



\* Renewal Kits → 8749RK → P299

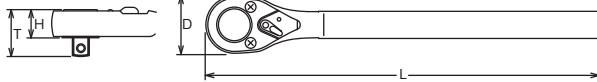

	D (mm)	T (mm)	H (mm)	L (mm)	(g)	(pce.)
8749	70	62.2	36.2	800	4100	1
8749-1000	70	62.2	36.2	1020	4720	1
New 8749-HEAD	70	62.2	36.2	220	2490	1
New PIPE-580	-	-	-	580	1610	1
New PIPE-800	-	-	-	800	2230	1

**8768**  
**8768-HEAD**  
**PIPE-400/-800**

Hinge Handle  
Gelenkgriff  
Poignée articulée

\* Renewal Kits → 8768RK → P300



	D (mm)	L (mm)	(g)	(pce.)
8768	55	600	2590	1
8768-1000	55	1000	3710	1
New 8768-HEAD	55	200	1480	1
New PIPE-400	-	400	1110	1
New PIPE-800	-	800	2230	1

**8785 / 8785-700**

T-Handle  
T-Griff  
Poignée coulissante

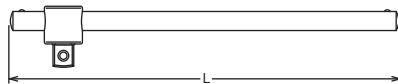

	L (mm)	(g)	(pce.)
8785	550	3190	1
New 8785-700	700	3906	1

**8788**

L-Handle  
L-Griff  
Poignée en L

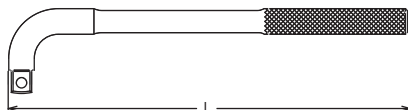
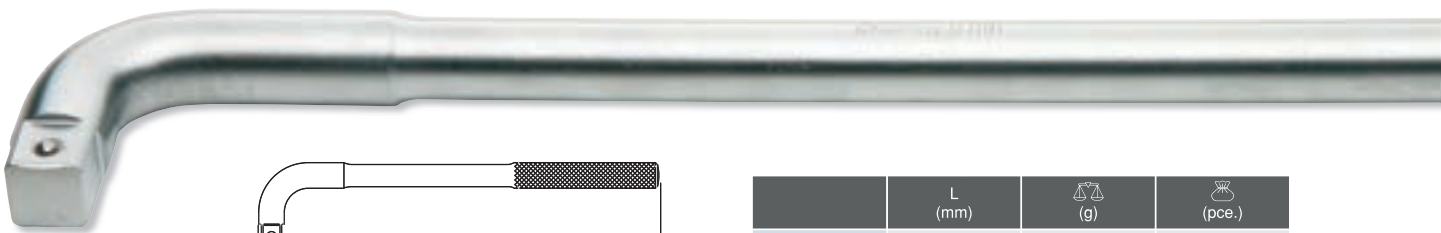

	L (mm)	(g)	(pce.)
8788	600	3600	1

# 1”

Hand Sockets  
Hand Steckschlüssel  
Douilles à main



Z-SERIES  
HAND  
TITANIUM  
ACCESSORIES  
SCREWDRIVERS  
IMPACT  
SLEEVE-DRIVE  
PROTECTOR  
INDUSTRIAL  
AUTOMOTIVE  
MOTORCYCLE  
CONSTRUCTION  
SPARE PART

Hand Sockets  
Hand Steckschlüssel 1”  
Douilles à main

Z-SERIES  
HAND  
TITANIUM  
ACCESSORIES  
SCREWDRIVERS  
IMPACT  
SLEEVE-DRIVE  
PROTECTOR  
INDUSTRIAL  
AUTOMOTIVE  
MOTORCYCLE  
CONSTRUCTION  
SPARE PART

**8225M-00** Socket Sets  
Steckschlüssel Sätze  
**8225M-05** Jeux de clés à douilles



8225M-00 15 Pieces Set/重量=27,000g  
8225M-05 15 Pieces Set/重量=27,000g

METAL CASE:W600xH217xT97mm

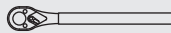
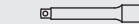
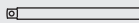
Sockets	Accessories
(8225M-00) <b>8400M</b> 6-pt. Sockets 32, 33, 36, 41, 46, 50, 55, 60, 65, 70, 75, 80	 <b>8749</b>
(8225M-05) <b>8405M</b> 12-pt. Sockets 32, 33, 36, 41, 46, 50, 55, 60, 65, 70, 75, 80	 <b>8760-200</b>  <b>8760-400</b>

